

强信
QIANG XIN



2025-2026



INDUSTRIAL SEWING MACHINE SPARE PARTS

工业缝纫机零配件



强信机械科技(莱州)有限公司

地址: 山东省莱州市城港路街道开明路2099号

电话: 0535-2292507~508

传真: 0535-2230380*2231838

E-mail: qiangxin@strongh.cn

网址: www.strongh.cn

邮编: 261400

STRONG H MACHINERY TECHNOLOGY CO.,LTD.

Add: No.2099 KAI MING RD., CHENGGANG

RESIDENTIAL DISTRICT, LAIZHOU SHANDONG CHINA

Tel: +86-535-2292507~508

Fax: +86-535-2230380*2231838

E-mail: qiangxin@strongh.cn

PC: 261400



手机扫描二维码, 即可获得相应页面产品的更多资讯!
More information about our products you can scan QR code with phone!

2025.9 第一次印刷

STRONG H

2025-2026

STRONG H MACHINERY TECHNOLOGY CO., LTD

1 假货公告

强信机械科技之 **STRONG H** 品牌，凭借优异的品质及良好的服务深受广大客户认可，拥有较高市场占有率和品牌影响力，因此被不法商贩仿冒及侵犯。

近期发现市场上有粘贴 **STRONG H** 防伪标签编码为“DH82099”的假冒产品。**STRONG H** 真品防伪标签为每一单只产品均有独立防伪编码，若出现多个单只产品为同一编码包装则为假冒。望广大用户留意产品防伪标签，请在正规授权渠道购买产品。

强信机械科技（莱州）有限公司依法享有  **STRONG H** 注册商标的版权及使用权，拥有 **STRONG H** 防伪标签的外观设计专利。我司将持续关注打击假冒伪劣产品，必要时将采取法律手段维护公司品牌及广大客户的权益。以上假冒情形敬请广大客户在购买使用 **STRONG H** 产品时认真辨别，如发现恶意侵权行为请及时向强信公司举报，一经查实追究，公司将给予相应奖励。

2 真伪产品识别

真品



真品防伪标签安全编码为
每一单只产品包装均有独立防伪编码



真品包装在商标左侧
镭有区域代码、发货日期

假冒品



假冒品防伪标签安全编码为
多个单只产品包装使用同一编码

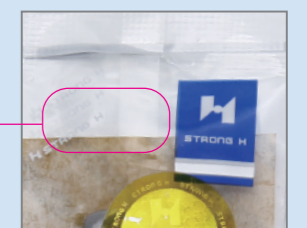

假冒品包装在商标左侧区域
无任何区域代码及日期信息



STRONG H 防伪标签
识别说明

举报电话：
0535-2292508

维护品牌产权，保护客户权益！





STRONG H 压商标工艺 产品推介
 TRADEMARK PRESSING CRAFTWORK & PRODUCTS PROMOTION
 INDUSTRIAL SEWING MACHINE SPARE PARTS



STRONG H 压商标工艺 产品推介
 TRADEMARK PRESSING CRAFTWORK & PRODUCTS PROMOTION
 INDUSTRIAL SEWING MACHINE SPARE PARTS



S02645-001/QX SL-737/S-7200
 S02645-001(H)/QX SL-737/S-7200
 S02646-001/QX S-7200
 S02646-001(H)/QX S-7200
 S02637-001/QX SL-737/S-7200

MF00A0838/QX LS2-180
 MF00A0834/QX LS2-180
 MF02A0838/QX PLKA-2010/1710
 MF02A0834/QX PLKA-2010/1710
 MG52A0838/QX DY-359
 MG52A0834/QX DY-359

SB1189-001/QX BE-438F/KE-430F
 SB1191-001/QX BE-438F/KE-430F
 SA3330-001/QX KE-430D
 SA3335-001/QX KE-430D
 SA3656-001/QX KE-430D
 SA3658-001/QX KE-430D
 BAS-311G/326G/342G

201121A/QX E52/L52/R53 EX3200/EX5200
 201121ANS/QX E52-131
 202295/QX E/L52/R
 2022950/QX M852-13
 204161/QX L32/W562
 204161A/QX W664-35
 B/QX R57

152901-001/QX LK3-B430
 152905-001/QX LK3-B430
 118-45609/QX MO-2414
 118-46003/QX LK3-B430
 13150503/QX MO-6700
 13150701/QX MO-6700
 B4121-522-000/QX DLM-522

KR23/QX 747/700K
 KR35/QX 747/700K
 1371A
 1371A
 71CL 1/2[C]/QX
 71CL 1/4[C]/QX
 71CL 3/4[C]/QX
 71CL 3/8[C]/QX
 71CL 5/8[C]/QX
 71CL 5/16[C]/QX
 71CL 7/16[C]/QX
 71CL 9/16[C]/QX
 71CL 7/8[C]/QX
 71CL 1[C]/QX
 71CL 1 1/4[C]/QX
 71CL 1 1/8[C]/QX
 71CL 1 3/8[C]/QX
 71CL 11/16[C]/QX

110-40052/QX DDL-5550N
 DDL-8700
 DDL 9000A/B
 DLU-5490
 D2406-555-D0H/QX DDL-5550N
 DDL-8700
 DDL 9000A/B
 DLU-5490
 D2406-555-B00/QX DDL-555-5
 114-09257/QX DDL-5550NH-7
 DDL-8700-7
 114-09604/QX DDL-5550NH-7
 DDL-8700-7
 B2421-280-0A0/QX LK-1850
 LK-1900
 LK-1900A
 B2424-280-000/QX LK-1850
 LK-1900
 LK-1900A

2100167/QX AZ8000
 FX0206010000/QX
 FX0207010000/QX
 KE063/QX
 KE064/QX

目录 INDEX

工业缝纫机刀类 KNIVES FOR INDUSTRIAL SEWING MACHINES

兄弟 BROTHER	2-6
杜克普 DURKOPP	6-8
龙帝 DINO	8
重机 JUKI	9-16
杰克 JACK	17-19
象王/威比玛 JUMBOKING/VIBEMAC	19-20
关西 KANSAI SPECIAL	21-22
宝狮 KINGTEX	22-23
三菱 MITSUBISHI	23-24
毛瑟/梅罗/百福 MAUSER/MERROW/PFAFF	22-24
飞马 PEGASUS	25-28
利满地 RIMOLDI	28-29
银箭 SIRUBA	30-32
日星 SUN STAR	32-33
胜家/利是/星菱 SINGER/REECE/SHING LING	33-34
星锐 SHING RAY	34
丰田/友联 TOYOTA/UNION SPECIAL	35
大和 YAMATO	35-38
吊牌切丁刀/金轮/耀翰/纽朗	
TAG SEWING CUTTER/GOLDEN WHEEL/YAO HAN/NEWLONG	38-39
其他 OTHERS	39-43
振动刀 VIBRATION CUTTER	43-44
兄弟/重机 BROTHER/JUKI	45
杜克普 DURKOPP	46
利华/利是 LSM/REECE	47
胜家/杰克 SINGER/JACK	48
杰克/重机/富士/银箭/飞马	
JACK/JUKI/HIKARI/SIRUBA/PEGASUS	49
中捷/其他 ZOJE/OTHERS	50
杰克 JACK	50-51
川田/美机 JUITA/MAQI	51
南邦/耐拓/中捷/中缝重工/大森	
NANBANG/NICERBA/ZOJE/CHNKI/DOSO	52

裁剪机系列刀类 KNIVES FOR CUTTING MACHINES

裁断机圆刀 ROUND KNIVES FOR END CUTTER MACHINES	54-56
底刀 LOWER KNIVES	60
分条机刀 CLOTH SLITTING KNIVES	61
削皮刀 SKIVING KNIFE	62
滚条机刀 CLOTH SLITTING KNIVES	63
CAD裁刀 CAD CUTTING KNIVES	64-67
钮门刀 BUTTON HOLE KNIVES	68
裁剪机直刀 STRAIGHT KNIVES FOR CUTTING MACHINES	69
裁剪机波刀 WAVE KNIVES FOR CUTTING MACHINES	70
钢带刀 BAND KNIVES	71

工业缝纫机针板剪线组件&梭床组

NEEDLE PLATE ASSEMBLY & SHUTTLE RACE ASSEMBLY FOR INDUSTRIAL SEWING MACHINES

兄弟 BROTHER	74-79
重机 JUKI	79-86
三菱/日星 MITSUBISHI/SUN STAR	87
大和 YAMATO	88
兄弟/重机 BROTHER/JUKI	89

工业缝纫机针位组

GAUGE SET FOR INDUSTRIAL SEWING MACHINES

兄弟 BROTHER	92-104
重机 JUKI	105-115
关西 KANSAI SPECIAL	116-129
宝狮 KINGTEX	130-131
飞马 PEGASUS	131-145
银箭 SIRUBA	145-155
大和 YAMATO	152-162

工业缝纫机针板 NEEDLE PLATE FOR INDUSTRIAL SEWING MACHINES

兄弟 BROTHER	164-166
重机 JUKI	166-169
杰克 JACK	169-170
关西 KANSAI SPECIAL	170-173
宝狮 KINGTEX	173-175
飞马 PEGASUS	175-178
银箭 SIRUBA	178-181
大和 YAMATO	181-184
星锐/星菱/日星 SHING RAY/SHING LING/SUN STAR	184
胜家/友联/海菱/威比玛/其他	
SINGER/UNION SPECIAL/HIGHLEAD/VIBEMAC/OTHERS	185

工业缝纫机牙齿 FEED DOG FOR INDUSTRIAL SEWING MACHINES

兄弟/重机 BROTHER/JUKI	186
关西 KANSAI SPECIAL	186-187
星锐/飞马/银箭 SHING RAY/PEGASUS/SIRUBA	187
日星/大和/其他 SUN STAR/YAMATO/OTHERS	188

工业缝纫机压脚 PRESSER FOOT FOR INDUSTRIAL SEWING MACHINES

兄弟/关西 BROTHER/KANSAI SPECIAL	189
重机 JUKI	189-190
飞马 PEGASUS	191
银箭 SIRUBA	191-192
大和 YAMATO	192-193

工业缝纫机针钳 NEEDLE CLAMP FOR INDUSTRIAL SEWING MACHINES

兄弟/重机/宝狮/星菱/关西	
BROTHER/JUKI/KINGTEX/SHING LING/KANSAI SPECIAL	194
飞马/百福/银箭 PEGASUS/PFAFF/SIRUBA	195
日星/大和 SUN STAR/YAMATO	196

工业缝纫机弯针 LOOPER FOR INDUSTRIAL SEWING MACHINES

兄弟 BROTHER	198-200
杜克普 DURKOPP	201
重机 JUKI	202-207
关西 KANSAI SPECIAL	207-210
宝狮 KINGTEX	210
飞马 PEGASUS	211-215
利满地/利是 RIMOLDI/REECE	216
银箭 SIRUBA	217-219
胜家 SINGER	219
星锐/威比玛/大和 SHING RAY/VIBEMAC/YAMATO	220-228

索引

PARTS LIST

229-257

扉页 HEAD PAGE

- STRONG H防伪标签升级
STRONG H Anti-fake label upgraded image
- STRONG H压商标工艺产品推介
STRONG H Trademark Pressing Craftwork&Products Promotion

■ 蓝色文字为产品品号
Item in blue is Part No.

■ 黑色文字为产品机型
Item in black is Model

New 新入册产品标识
New product entry identification

We always bringing you the BEST



Knives

for industrial sewing machines

工业缝纫机刀类

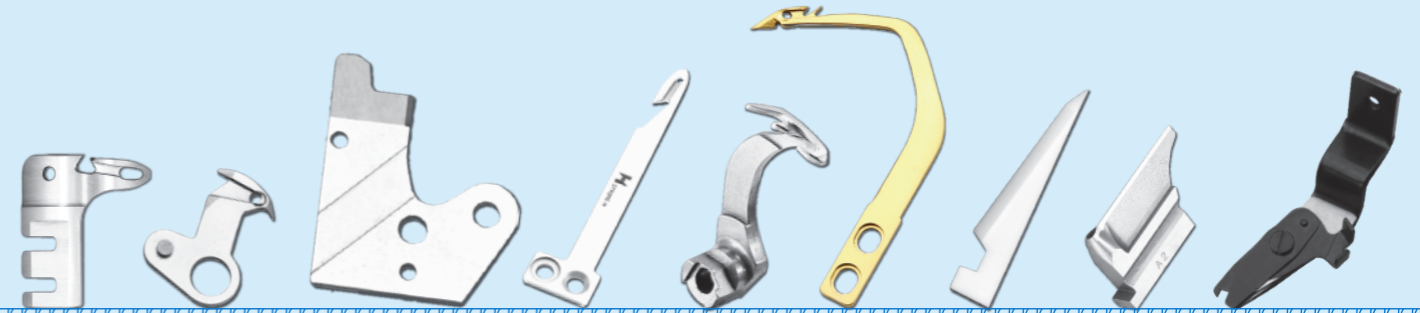

2025-2026

Industrial sewing machine spare components
工业缝纫机零配件部分



强信机械科技
STRONG H MACHINERY TECHNOLOGY

We always bringing you the BEST



Knives

for industrial sewing machines
工业缝纫机刀类

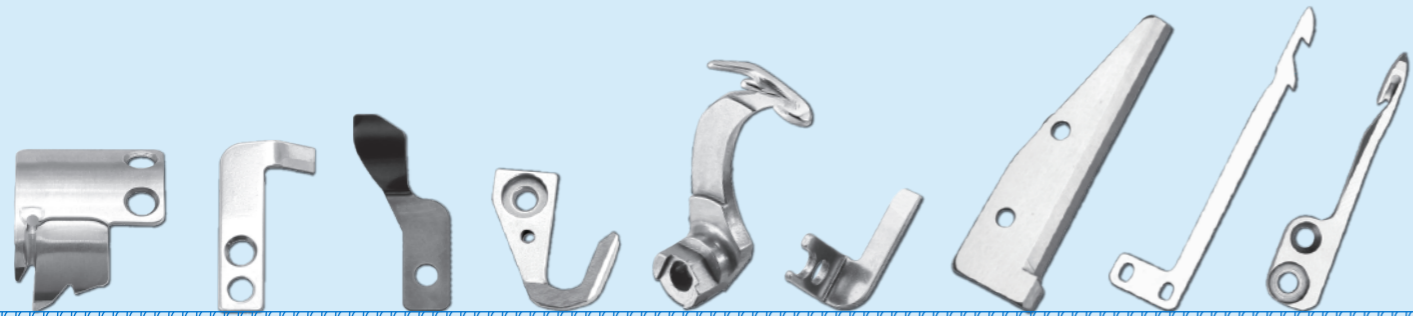

2025-2026

Industrial sewing machine spare components
工业缝纫机零配件部分



强信机械科技
STRONG H MACHINERY TECHNOLOGY

工业缝纫机刀类
KNIVES FOR INDUSTRIAL SEWING MACHINES
INDUSTRIAL SEWING MACHINES SPARE PARTS



FOR BROTHER/兄弟

1-1	1-2	1-3	1-4	1-5	1-6	1-7
112436-001 B531/B561	S28352-001 B272	S20582-001 N11	S20583-001 N11	S20899-001 N11	S09101-001 B271	144074-001 B531/N11/B641
2-1	2-2	2-3	2-4	2-5	2-6	2-7
144074-300 B531/B641	148342-001 B511/B561	148815-001 B531/B641	S20579-101 N11	S20896-101 N11	S20897-101 N11	S20898-101 N11
3-1	3-2	3-3	3-4	3-5	3-6	3-7
140242-001 B500/B600	S09093-001 B271	S09094-001 B271	S28348-001	140888-001 EF2-B531	S28650-201	S28654-001
4-1	4-2	4-3	4-4	4-5	4-6	
S16413-001 B787-4	S10605-001 SL-777B S-7780A	S07525-000 T8452/T8752	S07527-001 T8452/T8752	S07526-001 T-842/T-845 /T-875	S07526-201 T8452/T8752	

FOR BROTHER/兄弟

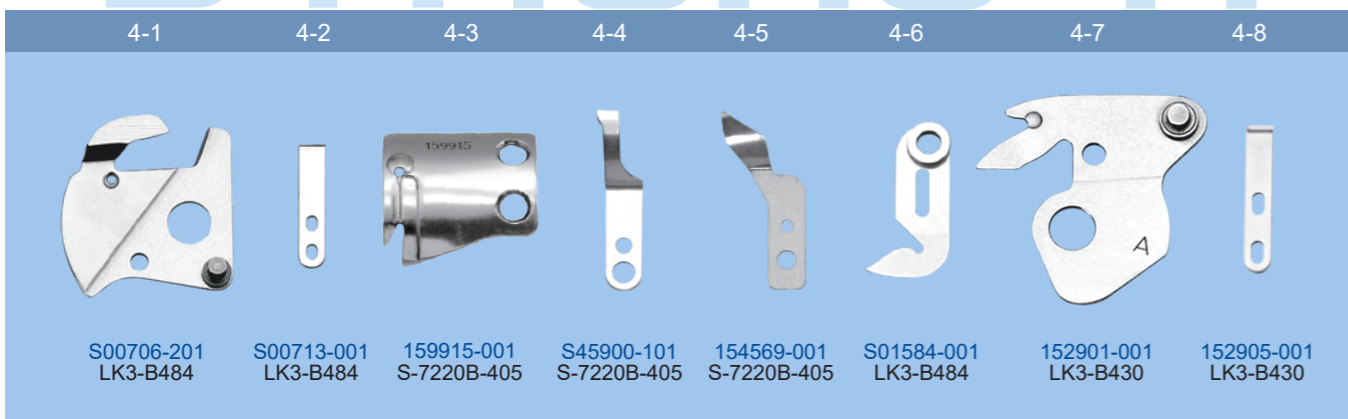
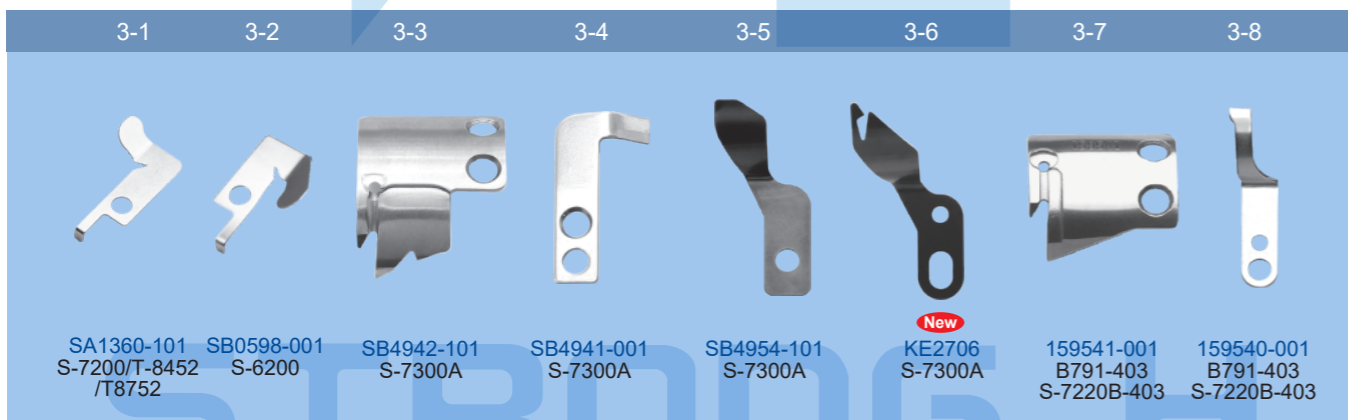
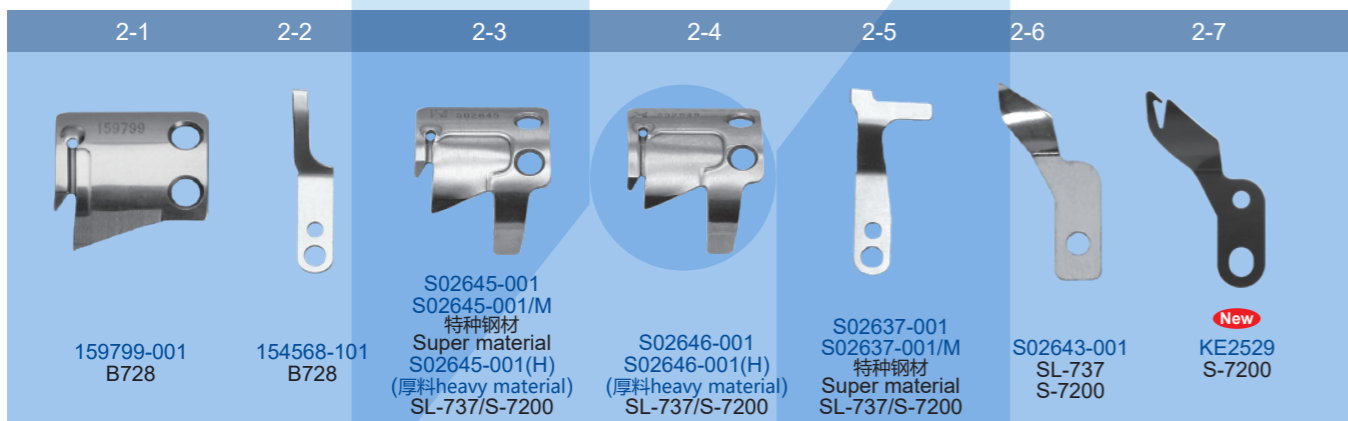
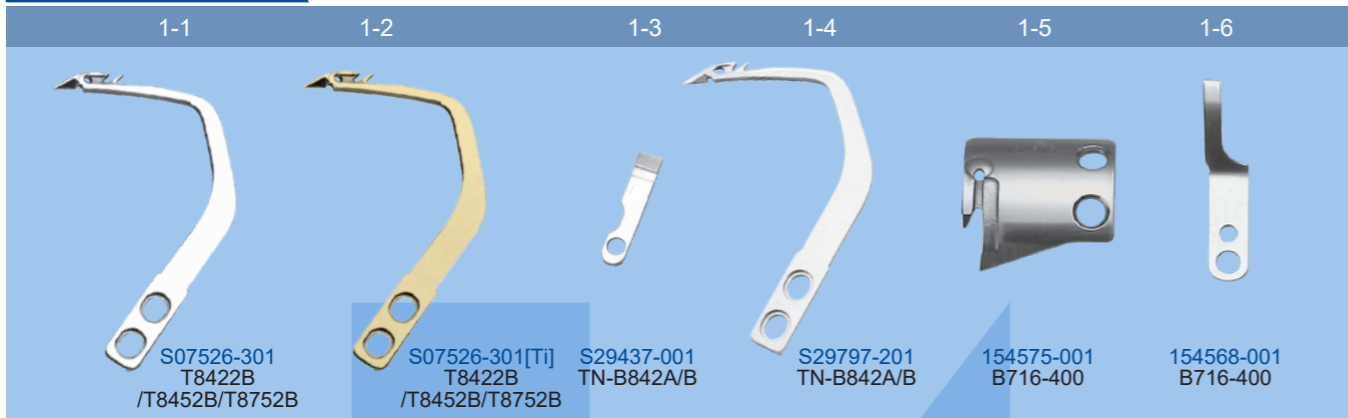

FOR BROTHER/兄弟

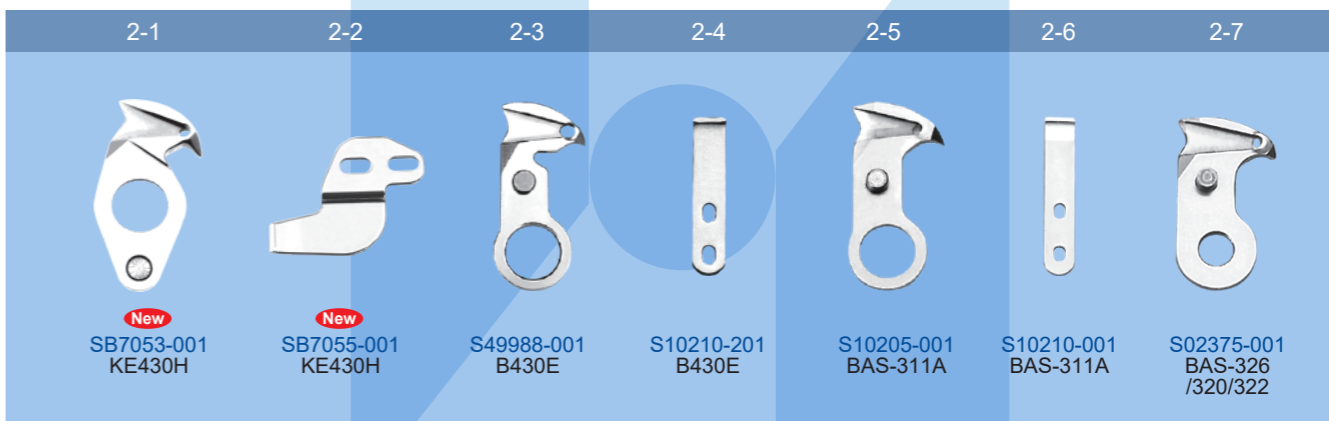
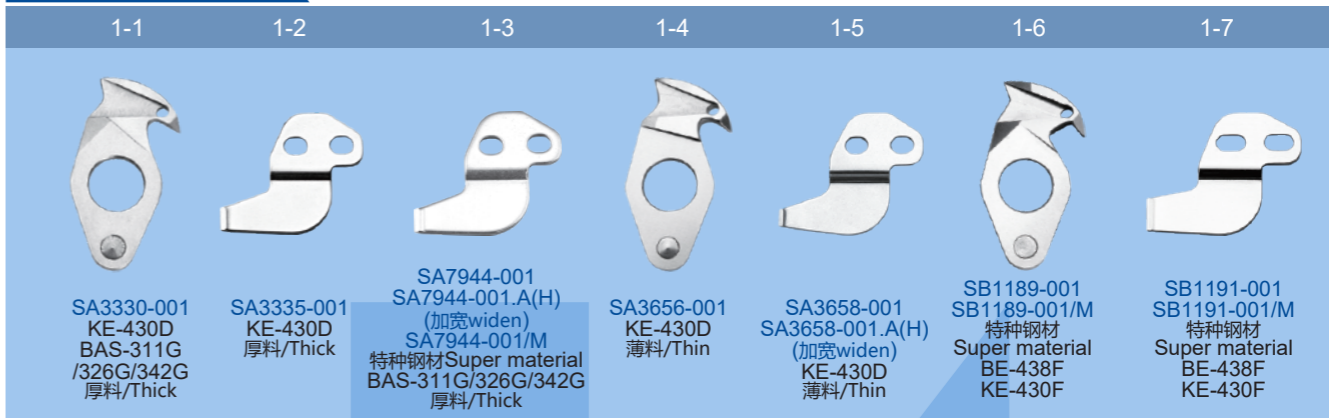

FOR BROTHER/兄弟

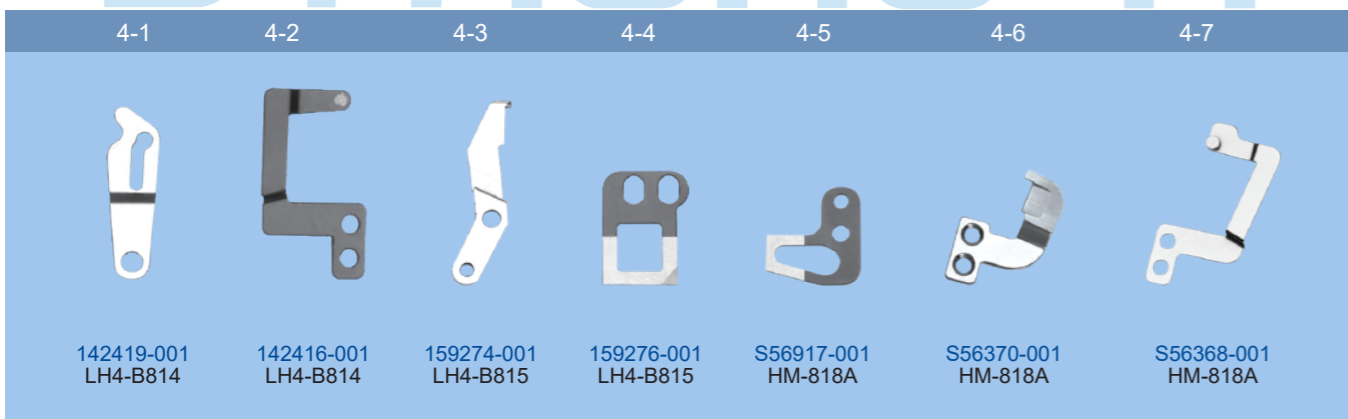
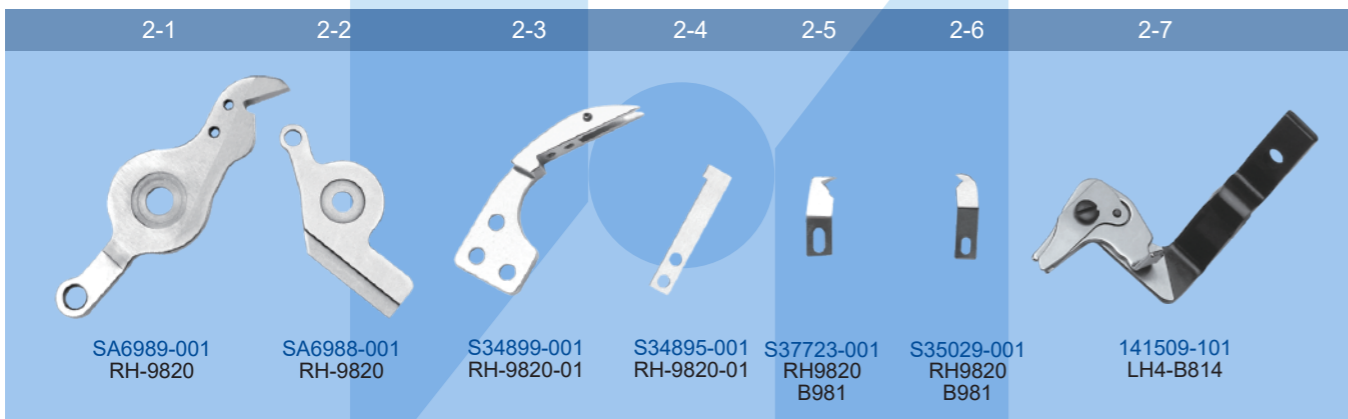
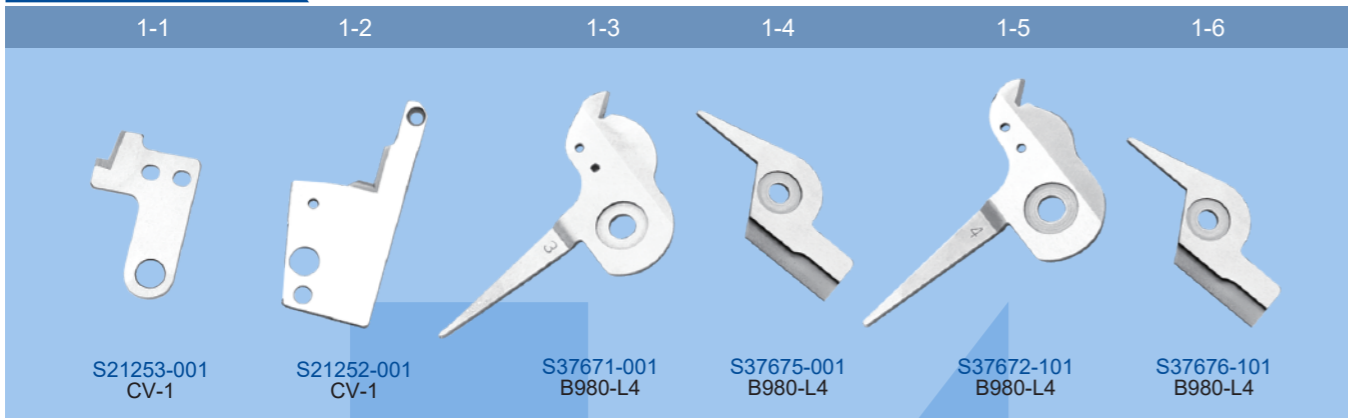

FOR BROTHER/兄弟

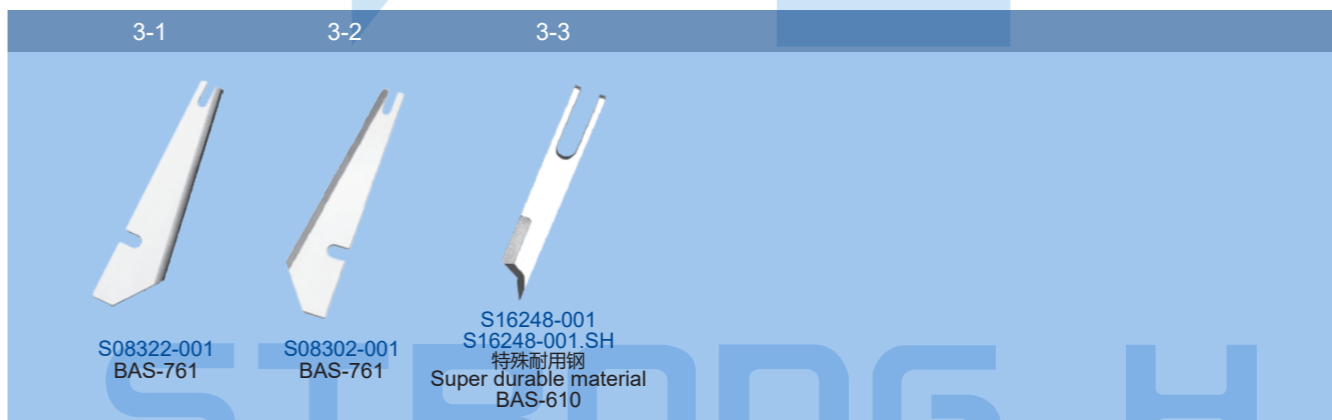
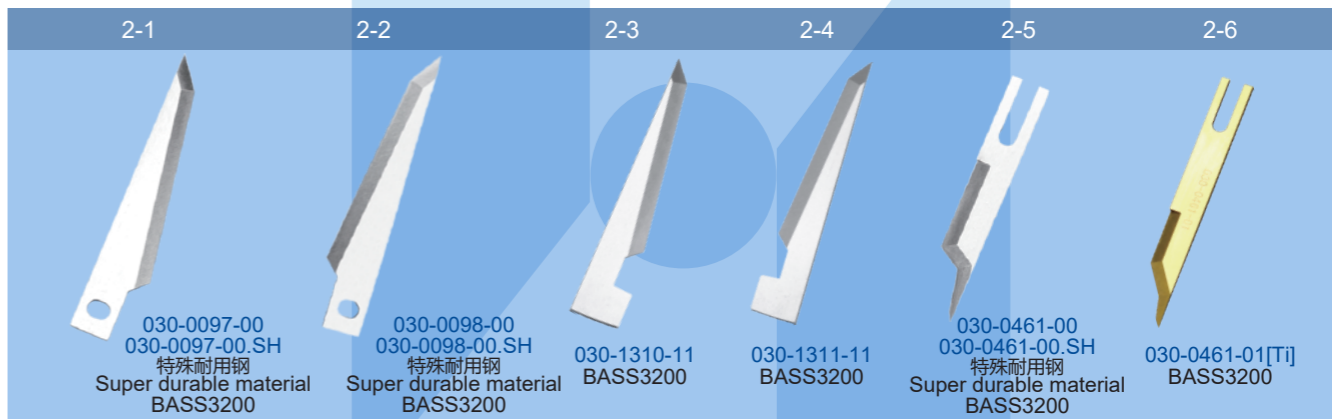
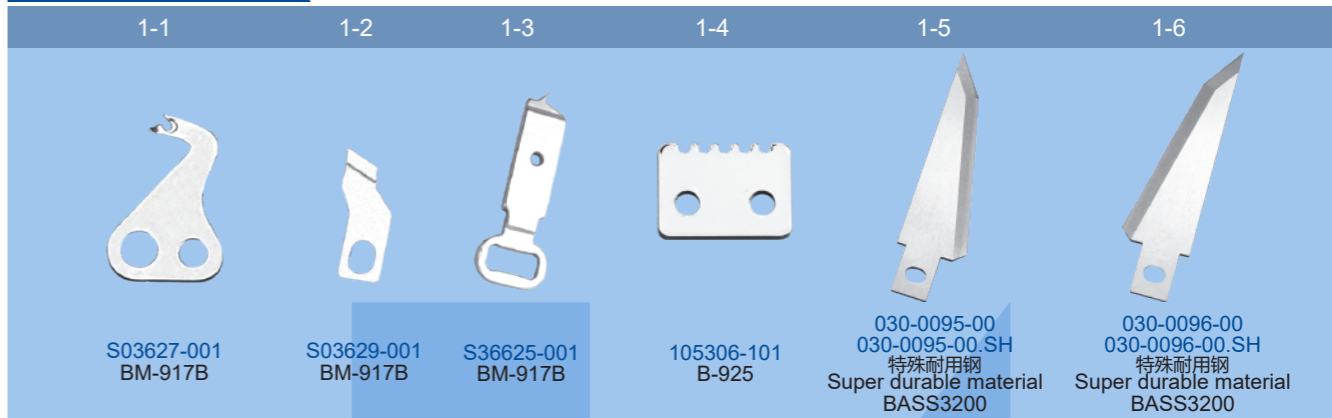

FOR DURKOPP/杜克普



FOR DURKOPP/杜克普

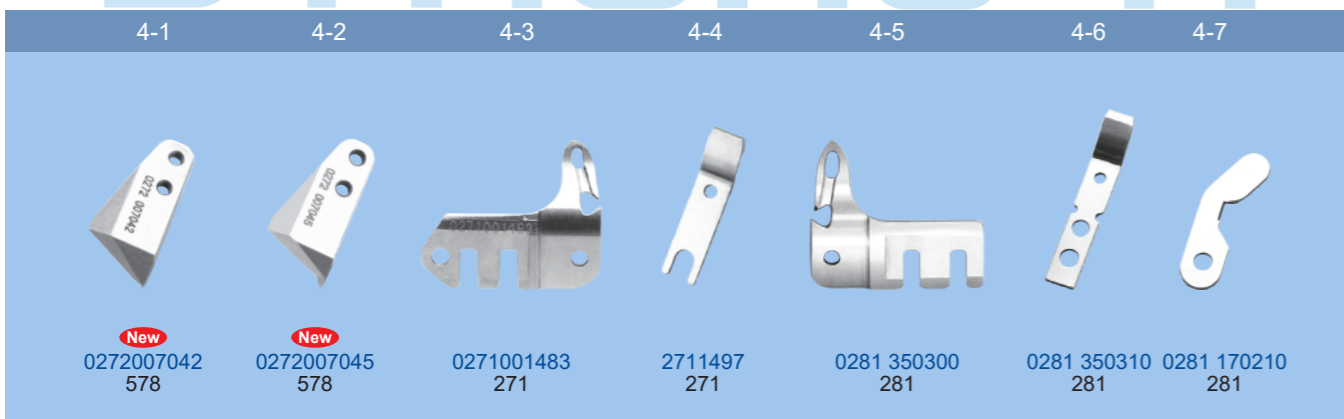
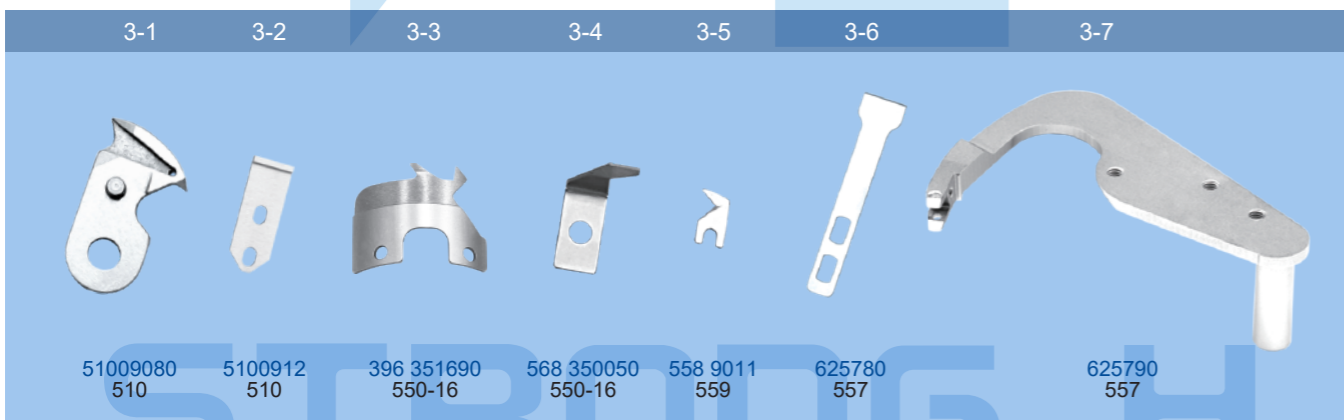
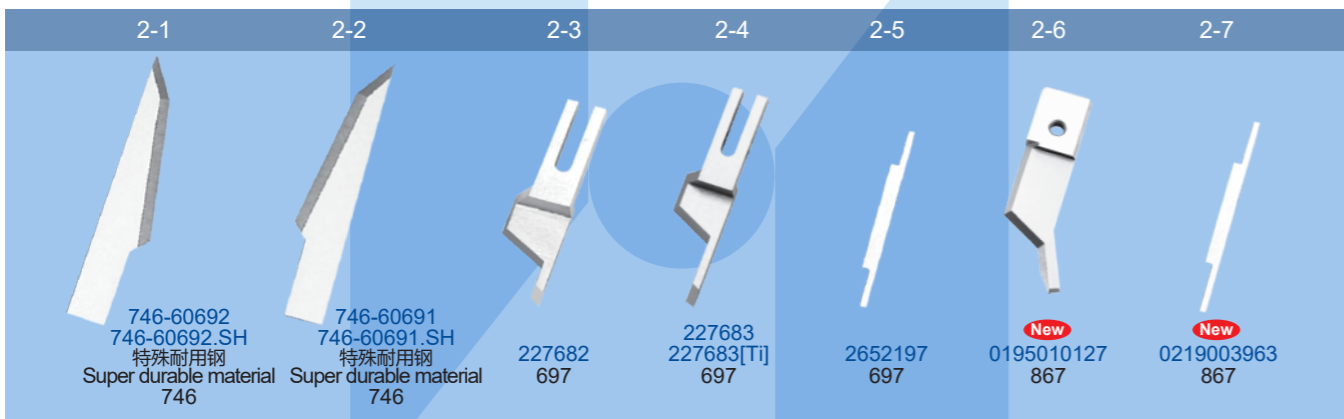
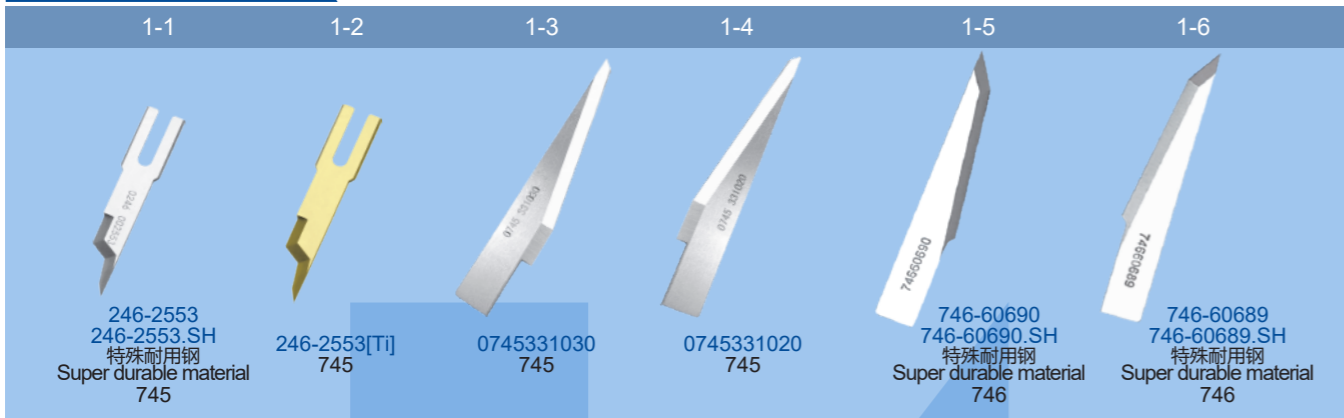

FOR DURKOPP/杜克普

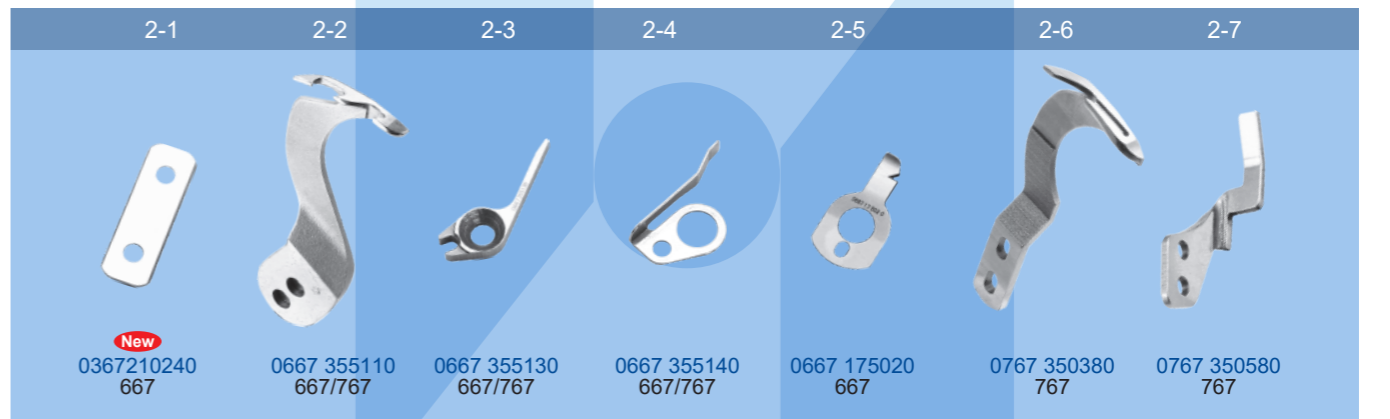
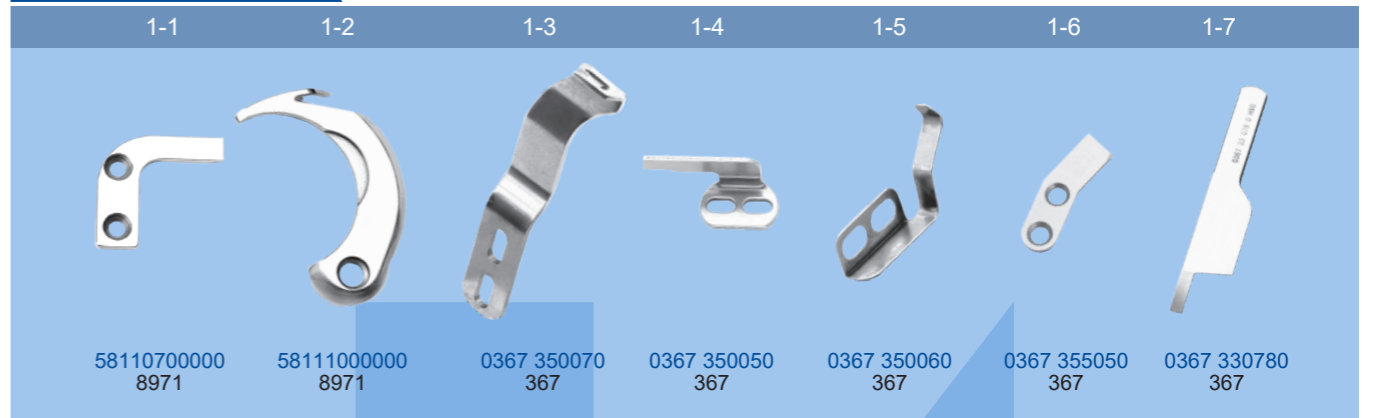

FOR DINO/龙帝



FOR JUKI/重机

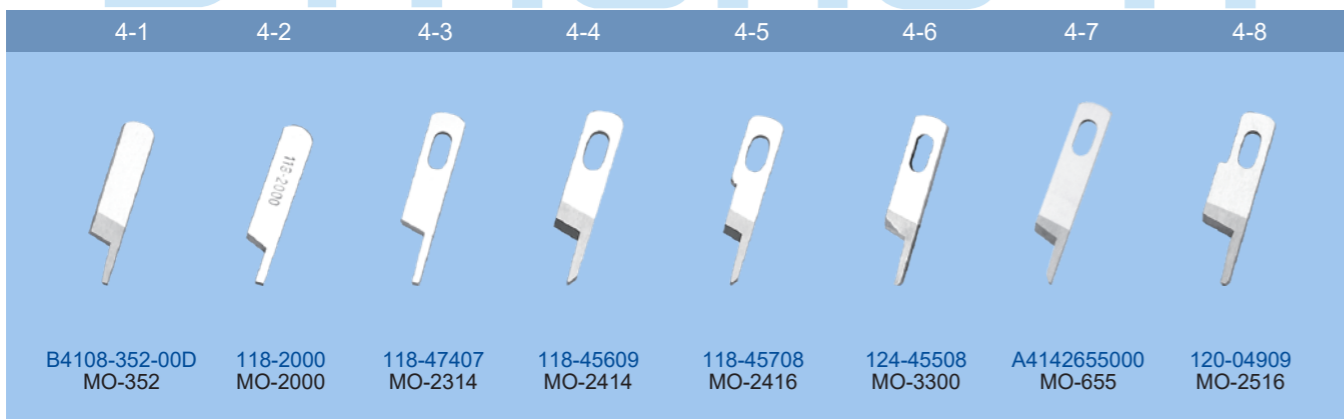
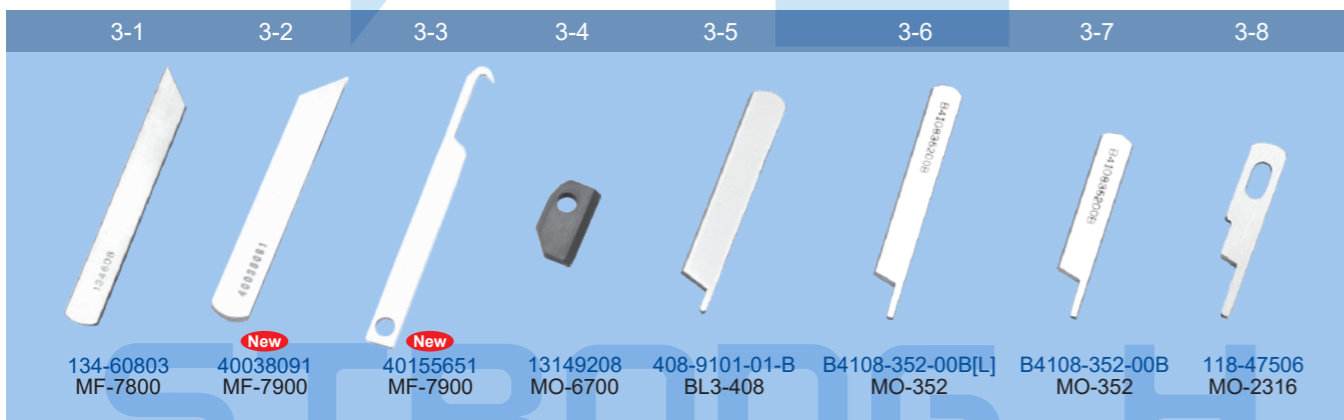
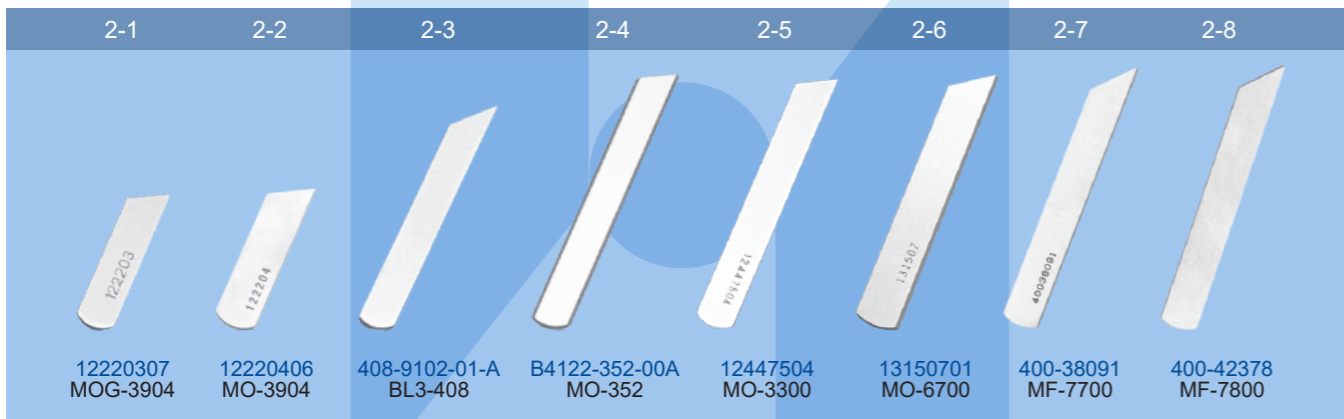
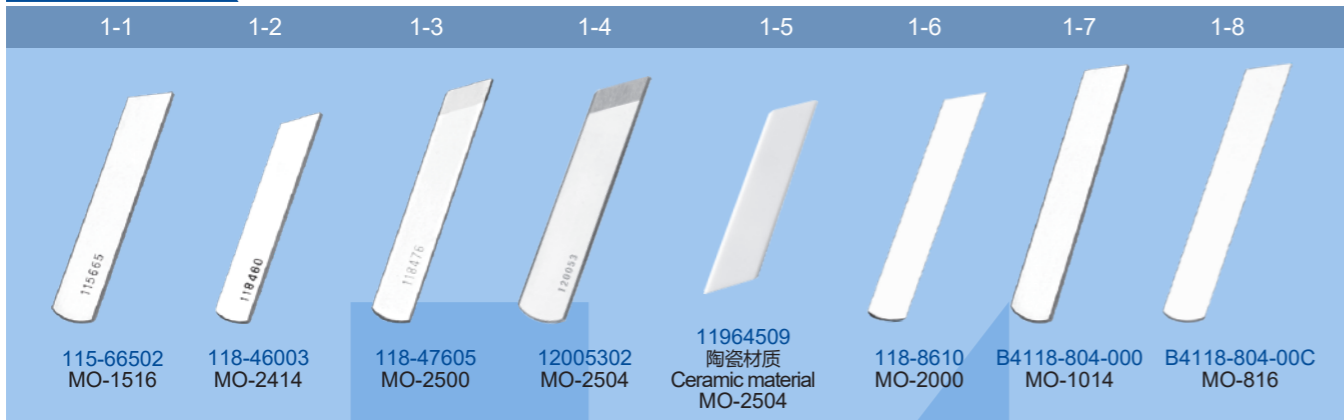

FOR JUKI/重机

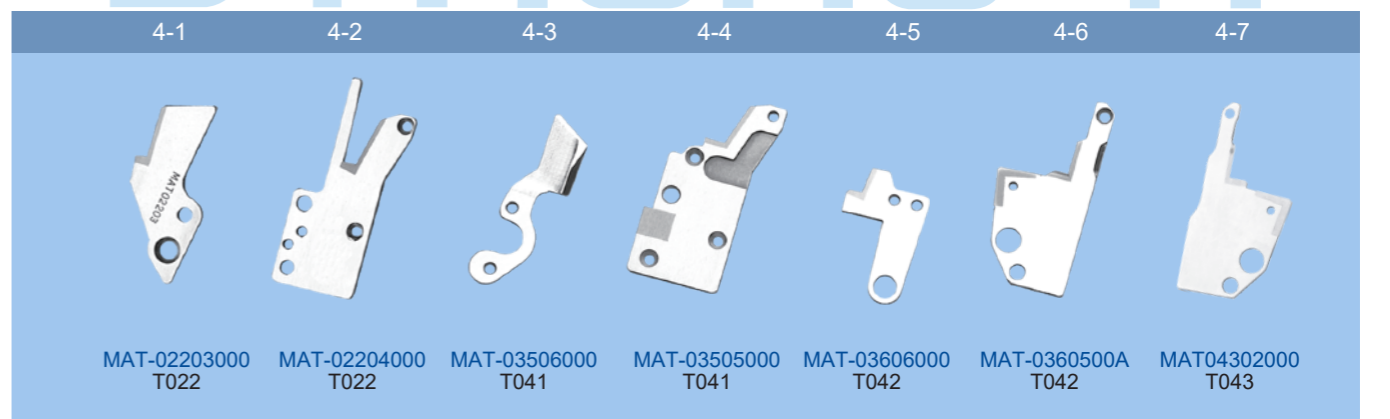
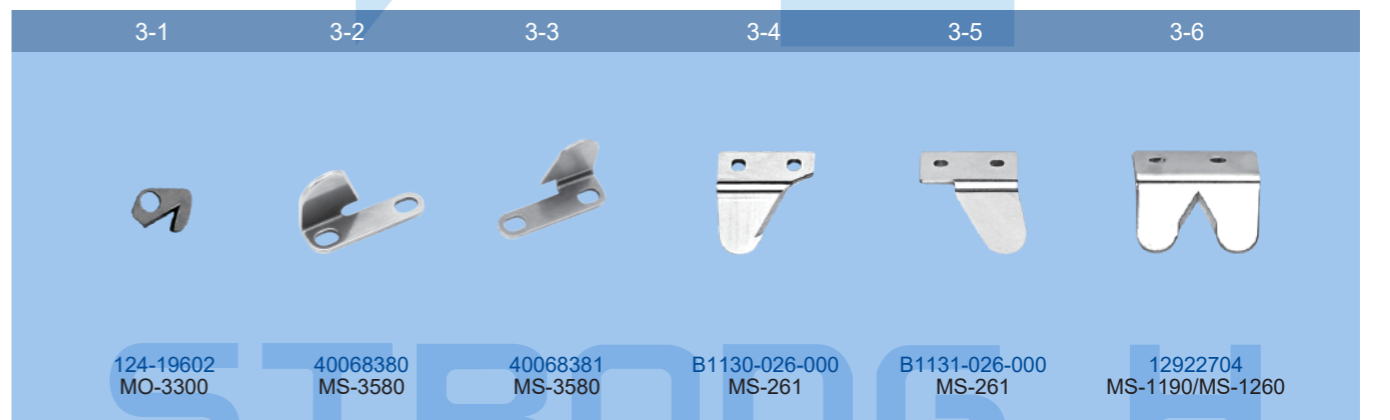
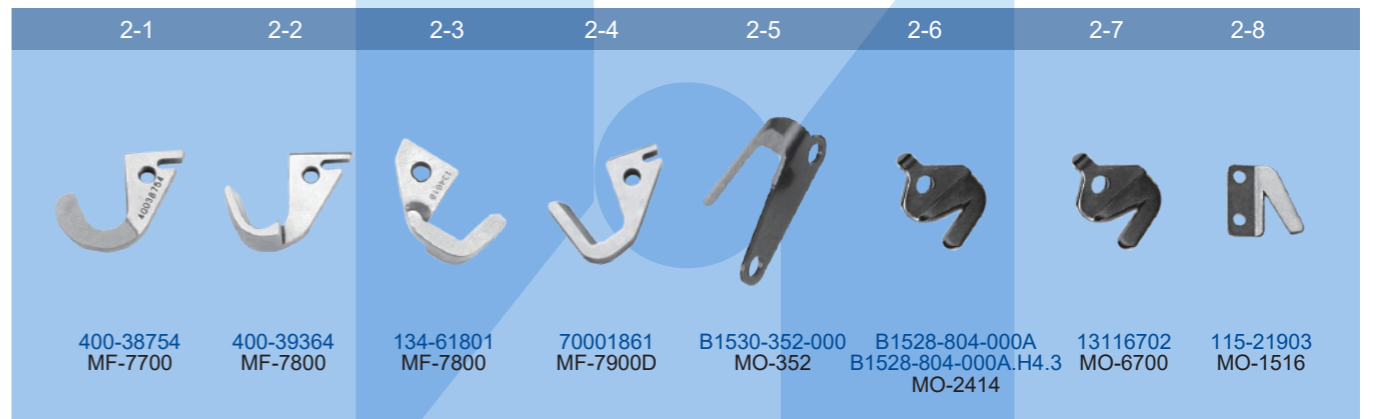
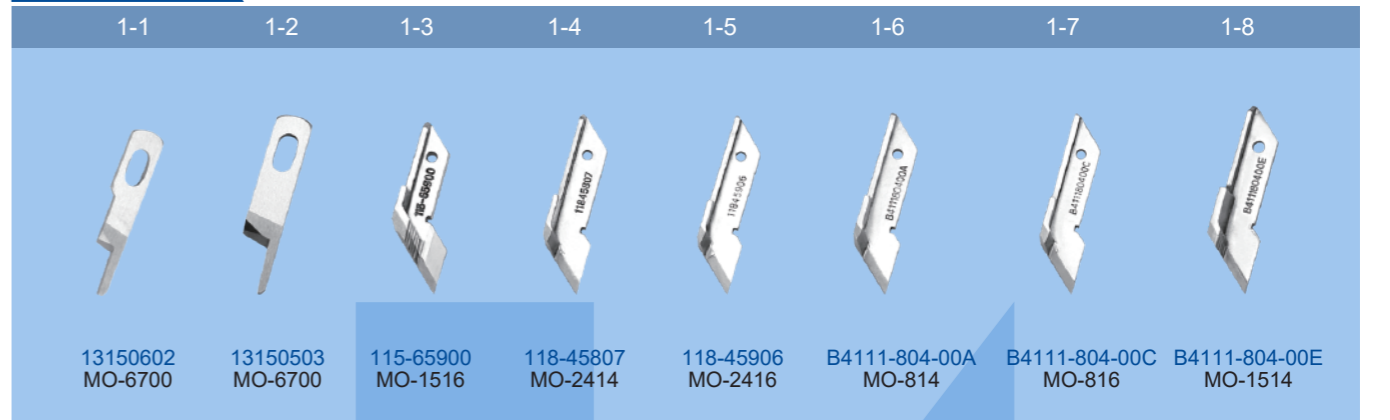

FOR JUKI/重机

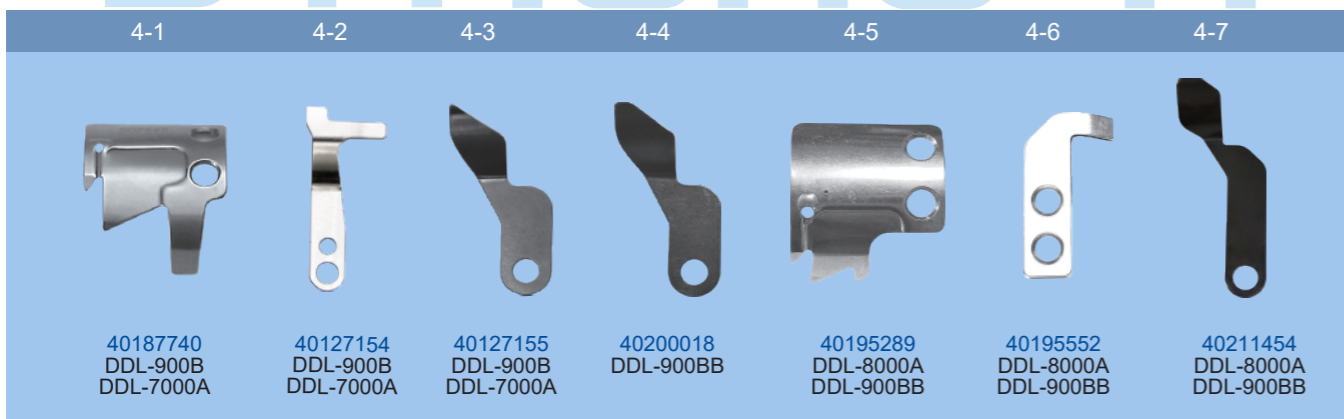
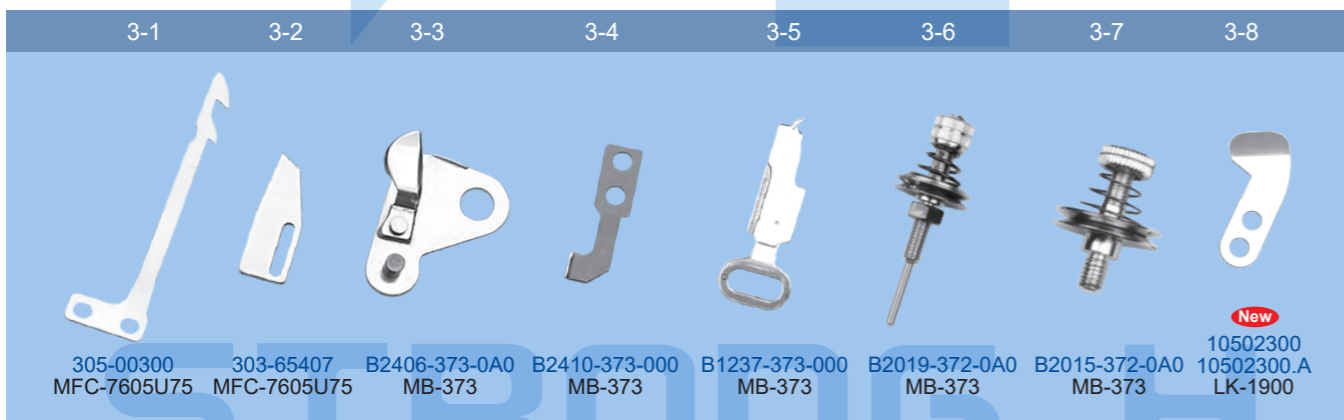
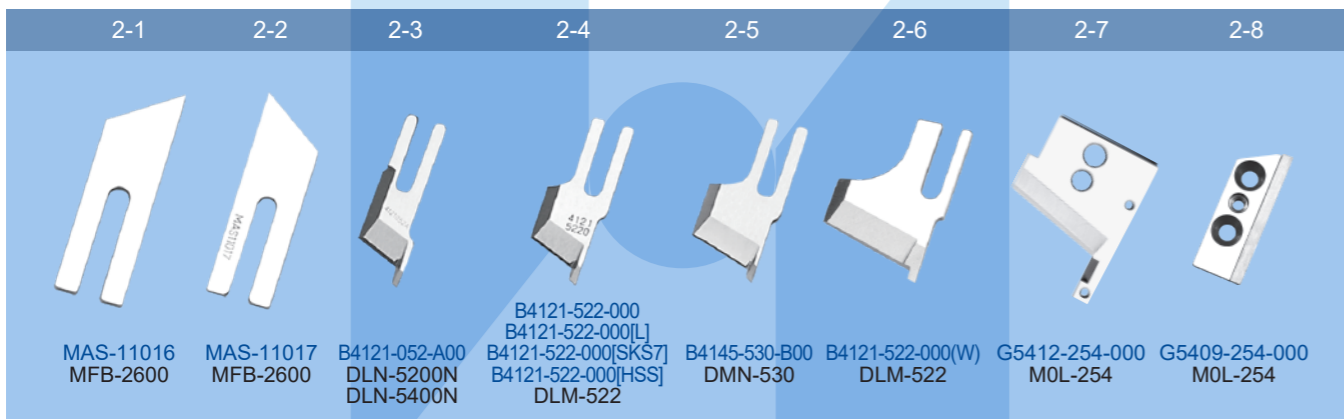
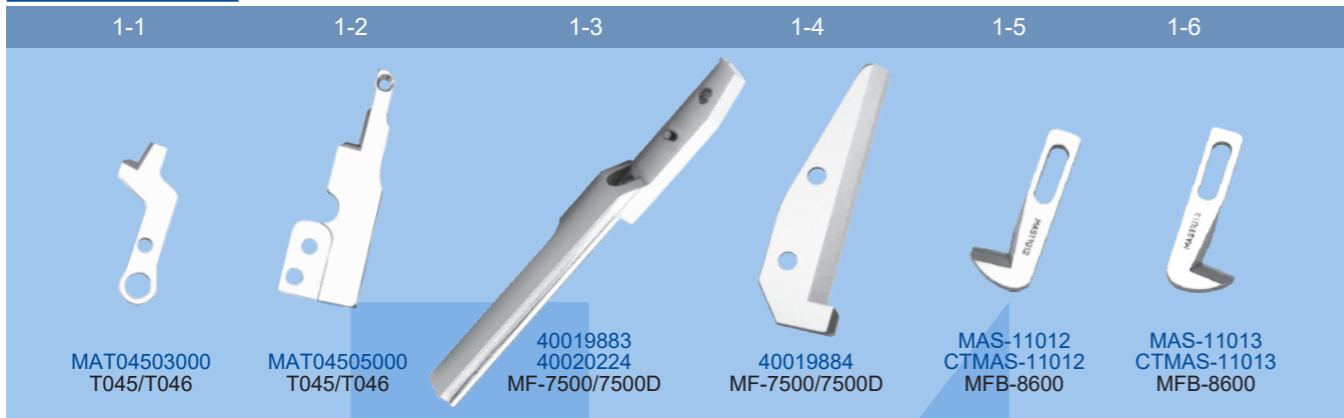

FOR JUKI/重机

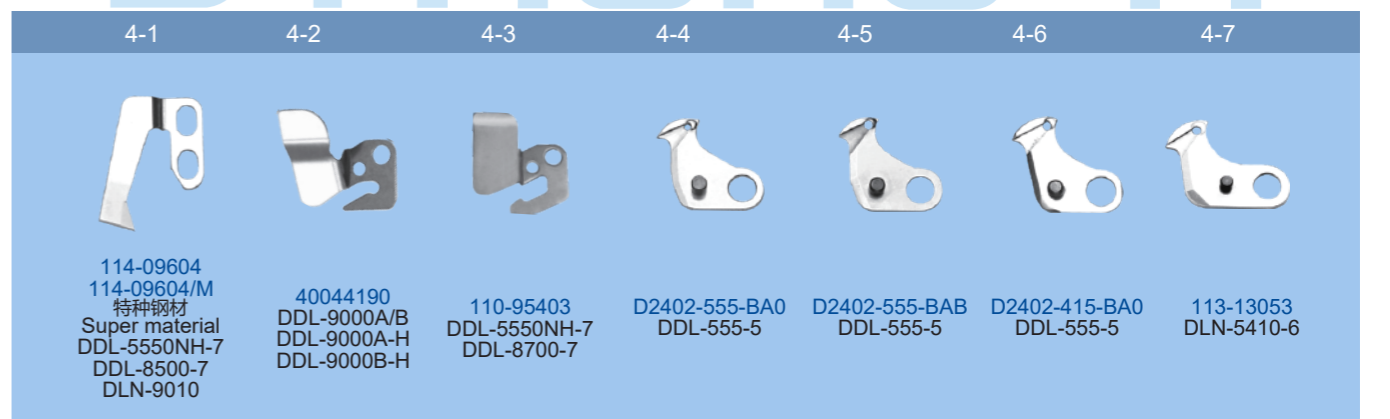
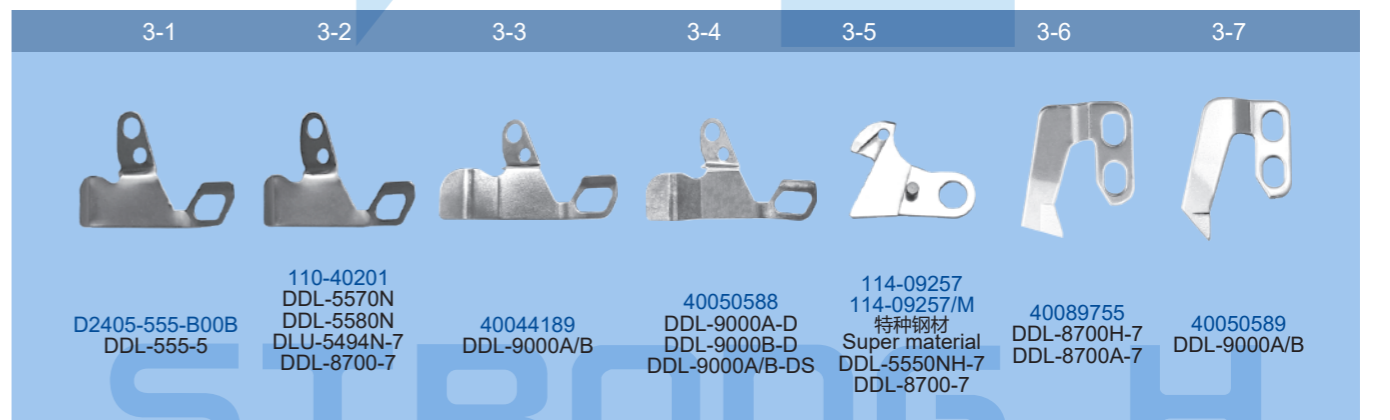
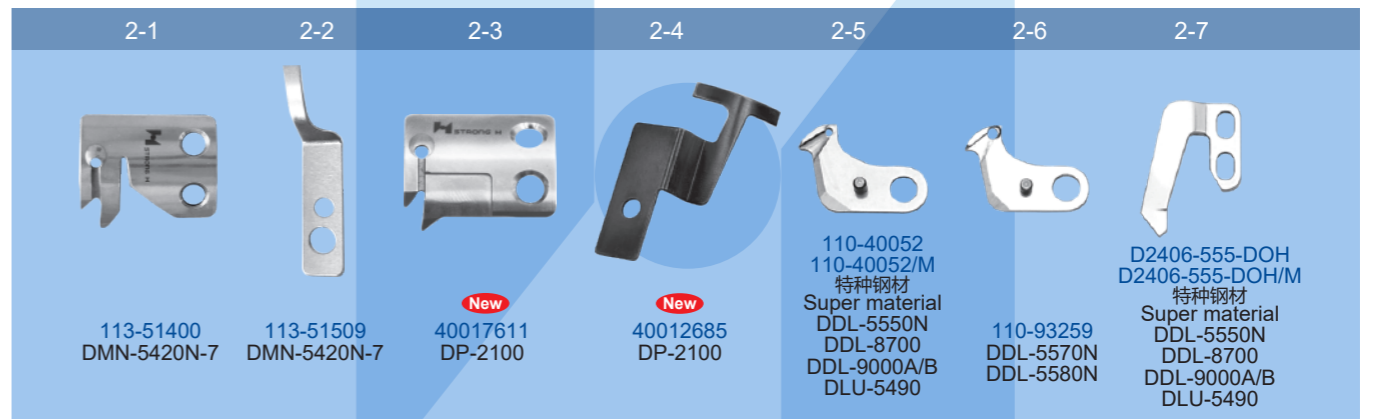
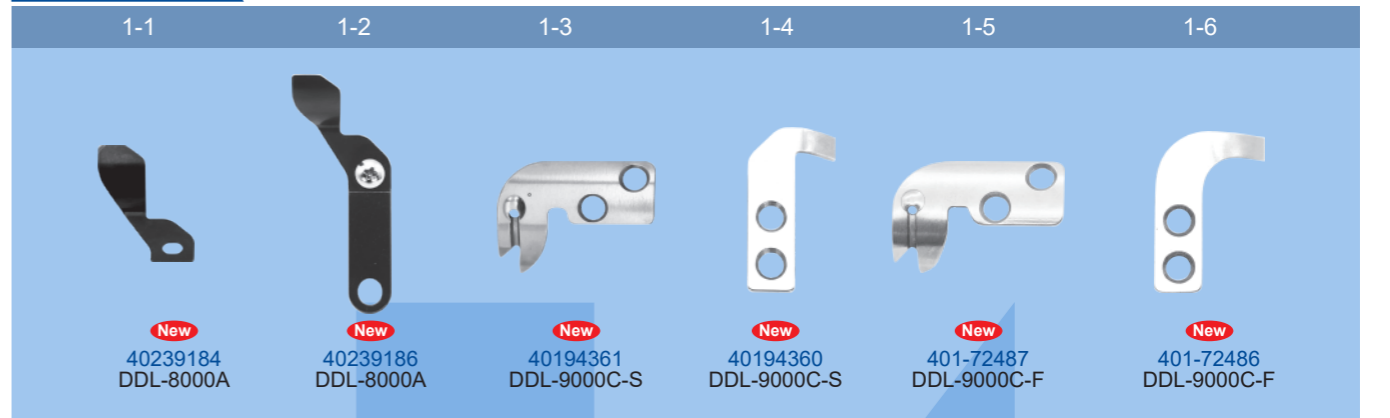



工业缝纫机刀类

KNIVES FOR INDUSTRIAL SEWING MACHINES

INDUSTRIAL SEWING MACHINES SPARE PARTS

FOR JUKI/重机

1-1	1-2	1-3	1-4	1-5	1-6	1-7
D2406-555-B00 DDL-555-5	D2401-530-D00 DMN-530-5	D2404-530-D00 DMN-530-5	B2421-280-0A0 B2421-280-0A0/M 特种钢材 Super material LK-1850 LK-1900/1900A	B2424-280-000 B2424-280-000/M 特种钢材 Super material LK-1850 LK-1900/1900A	New 40177341 LK-1900B	40179344 LK-1900B

2-1	2-2	2-3	2-4	2-5	2-6
138-81255 LK-1952 /1953/1954	B2421-210-AA0 AMS-210D	B2424-210-000 AMS-210D	B2421-210-000 AMS-210C	B2421-205-0A0 AMS-210C	B2424-210-A00 AMS-210C AMS-215C

3-1	3-2	3-3	3-4	3-5	3-6
New 70001791 MF-7900-UT37	40237599 MF-7900-UT -42/UT-45	40086274 MF-7800 MF-7900-UT	70004083 MF-7900-UT59	D2423-141-E00 DU-141-5	D2424-141-E00 DU-141-5

4-1	4-2	4-3	4-4	4-5	4-6
40086277 MF-7800 MF-7900-UT	110-42652 229-50356 DDL-8700 DDL-5550NH-7	D2408-555-CAO DDL-8700 DDL-5550NH-7	D3161-555-BAO DDL-8700	235-06009 LZ-2282N	235-06108 LZ-2282N

工业缝纫机刀类

KNIVES FOR INDUSTRIAL SEWING MACHINES

INDUSTRIAL SEWING MACHINES SPARE PARTS



FOR JUKI/重机

1-1	1-2	1-3	1-4	1-5	1-6	1-7	1-8
225-57557 LZ-2290A	225-57706 LZ-2290A	100-01709 LZ-2290	40196346 PLC-2800	40208387 PLC-2800	5649-116-A0A B116A	164-01002 APW-192/195	164-03008 APW-192/195

2-1	2-2	2-3	2-4	2-5	2-6
G5253-116-A00 APW-116	G5252-116-A00 APW-116	164-18709 164-18709.SH 特殊耐用钢 Super durable material APW-235	400-26155 400-26155.SH 特殊耐用钢 Super durable material APW-895	164-18600 164-18600.SH 特殊耐用钢 Super durable material APW-195	164-16109 164-16109.SH 特殊耐用钢 Super durable material APW-235

3-1	3-2	3-3	3-4	3-5	3-6
166-07301(A-1) 166-07301.SH(A-1) 特殊耐用钢 Super durable material APW-192	166-07400(A-2) 166-07400.SH(A-2) 特殊耐用钢 Super durable material APW-192	166-07301.CH(A-1) 陶瓷材质 Ceramic material APW-192	166-07400.CH(A-2) 陶瓷材质 Ceramic material APW-192	166-07509(B-1) 166-07509.SH(B-1) 特殊耐用钢 Super durable material APW-192	166-07608(B-2) 166-07608.SH(B-2) 特殊耐用钢 Super durable material APW-192

4-1	4-2	4-3	4-4	4-5	4-6
166-07509.CH(B-1) 陶瓷材质 Ceramic material APW-192	166-07608.CH(B-2) 陶瓷材质 Ceramic material APW-192	166-07707(C-1) 166-07707.SH(C-1) 特殊耐用钢 Super durable material APW-192	166-07806(C-2) 166-07806.SH(C-2) 特殊耐用钢 Super durable material APW-192	166-07707.CH(C-1) 陶瓷材质 Ceramic material APW-192	166-07806.CH(C-2) 陶瓷材质 Ceramic material APW-192



工业缝纫机刀类

KNIVES FOR INDUSTRIAL SEWING MACHINES

INDUSTRIAL SEWING MACHINES SPARE PARTS

FOR JUKI/重机

1-1	1-2	1-3	1-4	1-5	1-6	1-7	1-8
16409906 APW-895	400-33814 APW-895/896 (8mm)	400-23020 APW-895/896 (10/12mm)	400-33809 APW-895/896 (14/16mm)	D2401-481-CD0 MH-481-4	D2405-481-C00A MH-481-4	40034923 MEB-3200	32020919 MEB-3200

2-1	2-2	2-3	2-4	2-5	2-6	2-7	2-8
32018012 MEB-3200	32020703 MEB-3200	32016107 MEB-3200	32023319 MEB-3200	32023210 MEB-3200	320-20505 MEB-3200	400-15996 MEB-3200	32018509 MEB-3200

3-1	3-2	3-3	3-4	3-5	3-6	3-7
B1528-380-0A0 MH-380	13458500 MF-7800-UT25A UT33A	40029004 MF-7800-UT25 UT33	23138209 MP-200N	23136005 MP-200N	B2408-761-000 LBH-761	B2406-761-0A0 LBH-761

4-1	4-2	4-3	4-4	4-5	4-6
B2406-771-0A0 LBH-780	B2408-771-000-A LBH-780	B2001-761-0A0 LBH-761	B2001-762-0A0 LBH-762	B2001-763-0A0 LBH-763	B2001-771-0A0 LBH-780

工业缝纫机刀类

KNIVES FOR INDUSTRIAL SEWING MACHINES

INDUSTRIAL SEWING MACHINES SPARE PARTS



FOR JUKI/重机

1-1	1-2	1-3	1-4	1-5	1-6	1-7
137-31161 LBH-790/791	137-35469 LBH-790/791	400-04255 LBH-1790	400-04311 LBH-1790	139-47866 LBH-1790/791	107-26305 LU-2216N-7	107-26404 LU-2216N-7

2-1	2-2	2-3	2-4	2-5	2-6	2-7
213-89200 LU-1560N-7	213-89309 LU-1560N-7	40195311 PLC-2800	40169705 LU-2800	40220191 LU-2810	40222677 LU-2810	40235075 LH-4500 New

3-1	3-2	3-3	3-4	3-5	3-6	3-7
400-12403 LH-3528-7	400-12404 LH-3528-7	400-76709 LH-3528-7	40033160 LH-3500	226-55302 LH-3128-7	228-20302 LH-3178-7	10211605 LH-3128-7 LH-3178-7

4-1	4-2	4-3	4-4	4-5	4-6
40025949 LH-4128-7 LH-4178-7	102-32403 LH-1162	102-11209 LH-1162/1152	102-11118 LH-1162/1152	40091839 AB-1351 New	40091822 AB-1351 New



工业缝纫机刀类

KNIVES FOR INDUSTRIAL SEWING MACHINES

INDUSTRIAL SEWING MACHINES SPARE PARTS

FOR JACK/杰克

1-1	1-2	1-3	1-4	1-5	1-6	1-7
115019045 114119002 A2/A4/A4S/ JK-9200/迅利II	11319002 11319003 A2/A4/A4S/ JK-9200/迅利II	115019001 113119001 A2/A4/A4S/ JK-9200/迅利II	13819002 A3	11312003 JK-8910D A2/A4/A4S/ JK-9200/迅利II	New 113813029 A4/A4H/A5 快返王	113819005 JK-A4-H

2-1	2-2	2-3	2-4	2-5	2-6	2-7
13719005 JK-9300D 9300E 迅利III E	13719006 JK-9300D 9300E 迅利III E	115019006 14119004 A4S/AS-X/A5/ A5-X/A5-N	14119002 14119005 A4S/AS-X/A5/ A5-X/A5-N	14112001 A4S/AS-X/A5/ A5-X/A5-N	14119003 A5	14013009 A4S/A5/A5S

3-1	3-2	3-3	3-4	3-5	3-6	3-7	3-8
13619002 JK-6380D JK-6380E	13619001 JK-6380D JK-6380E	13612010 JK-6380D JK-6380E	13119004 JK-8995	13119001 JK-8995	13112007 JK-8995L	14019001 A4S/A5/A5S	14019002 A4S/A5/A5S

4-1	4-2	4-3	4-4	4-5	4-6	4-7
112319002 JK-58450J	12319001 JK-58450J	12327002 JK-58450J	12919303 JK-58420D JK-58450D JK-58720D JK-58750D	12919304 JK-58420D JK-58450D JK-58720D JK-58750D	12927200 JK-58420D JK-58450D JK-58720D JK-58750D	20119002 JK-800/798/ 900E/C4/C5

工业缝纫机刀类

KNIVES FOR INDUSTRIAL SEWING MACHINES

INDUSTRIAL SEWING MACHINES SPARE PARTS



FOR JACK/杰克

1-1	1-2	1-3	1-4	1-5	1-6	1-7	1-8
121119001 C4	121119009 C4-2203	31019006 K4	21317002 C6	20419001 JK-797	New 20619004 JK-788	30219002 JK-8669	New 131619005 K6-4204

2-1	2-2	2-3	2-4	2-5	2-6	2-7	2-8
20701053 JK-798/798D/C4 C5/798T/900E/E4	20719005 JK-798D/900E/ C4/C5	20719007 JK-798/798E JK-800/900E JK-C4/C5	20619009 JK-798/798D/ C4/C5/798T/ 900E/E4	20719050 JK-798D/798DIII/ 798T/900E/ E4/C4/C5	30119001 JK-8569-W05	30219001 JK-8669	131619005 K6-2501

3-1	3-2	3-3	3-4	3-5	3-6	3-7
30119020 JK-8569/8669 JK-8670/K4/ W4/E4	12519001 JK-8558W/8560W/ 8558WD/8560WD/ 855G/8560G	New 112819004 JK-5559F-0833	30119008 JK-8569/8669 JK-8670 JK-K4/W4	30119009 JK-8569/8669 JK-8670 JK-K4/W4/E4	30119006 JK-8569/W4	30119010 JK-8569/W4

4-1	4-2	4-3	4-4	4-5	4-6	4-7	4-8
30219008 JK-8669/K4	30219009 JK-8669/K4	30219003 JK-8670	30219004 JK-8670	30119014 JK-8569/W4	30119013 JK-8569/W4	40619003 JK-9270 JK-9280	40619004 JK-9270 JK-9280



工业缝纫机刀类

KNIVES FOR INDUSTRIAL SEWING MACHINES

INDUSTRIAL SEWING MACHINES SPARE PARTS

FOR JACK/杰克

1-1	1-2	1-3	1-4	1-5	1-6	1-7
140619001 JK-9270 JK-9280	40619005 JK-9270 JK-9280	4021900100 JK-781D JK-781E	4021900500 JK-T781D JK-T781E	40219007 JK-T781D JK-T781E	4131900200 JK-T1790B	4131900300 JK-T1790CS

2-1	2-2	2-3	2-4	2-5	2-6	2-7	2-8
4091900100 JK-T1373/ 1377/1377E	40919003 JK-T1373/ 1377/1377E	40319007 JK-1900G JK-1900GS	40319008 JK-1900G JK-1900GS	New 140319001 JK-T1900G	New 140319002 JK-T1900G	4170900300 JK-1310/2210/ 3020/6040/10040	41709002 JK-1310/2210/ 3020/6040/10040

3-1	3-2	3-3	3-4	3-5
40719302 JK-5878-58B	40719301 JK-5878-58B	New 150419002 Z7	New 150419001 Z7	New 150412003 Z7

FOR JUMBOKING/象王

4-1	4-2	4-3	4-4	4-5	4-6
981-886 WR-981M	981-888 WR-981M	981-889 WR-981M	185219001 4650UV9-04-079	185219002 101TE 4650UV9-04-079 3650	185219004 540760 4650UV9-04-079 3650

FOR VIBEMAC/威比玛

FOR VIBEMAC/威比玛

1-1	1-2	1-3	1-4	1-5	1-6	1-7
185319002 185319003 3022BHE	185319001 185319004 3022BHE	1650-161-RT 3650	3650-001 3650	3650-303 3650	20RAS261 2261HP	10RAS261 2261HP

2-1	2-2	2-3	2-4	2-5	2-6
New 18011900100 UAM04	New 182119002 UAM04	48119003 RS-0706	48119004 RS-0706	82119201 UAM04	82119202 UAM04

3-1	3-2	3-3	3-4	3-5	3-6	3-7
New 185209102 4650EV9	New 18211900100 UAM04	18561900300 V700	18561900200 V700	185519303 S2220	18551930100 S2220	185119002 2261

4-1	4-2	4-3	4-4
18510911000 V2261HP	New 185119104 V2261HP	New 182319201 UAM03	New 182319202 UAM03

FOR KANSAI SPECIAL/关西

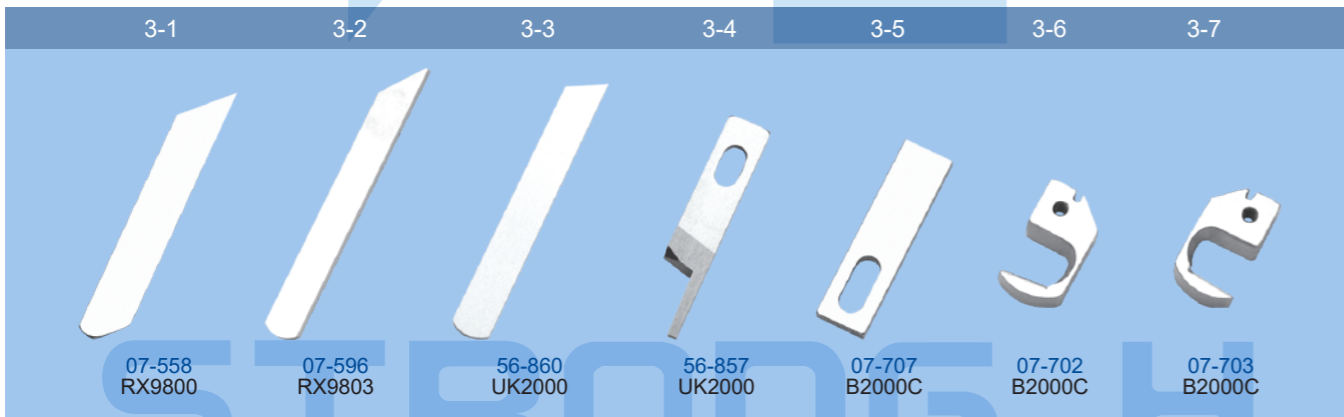
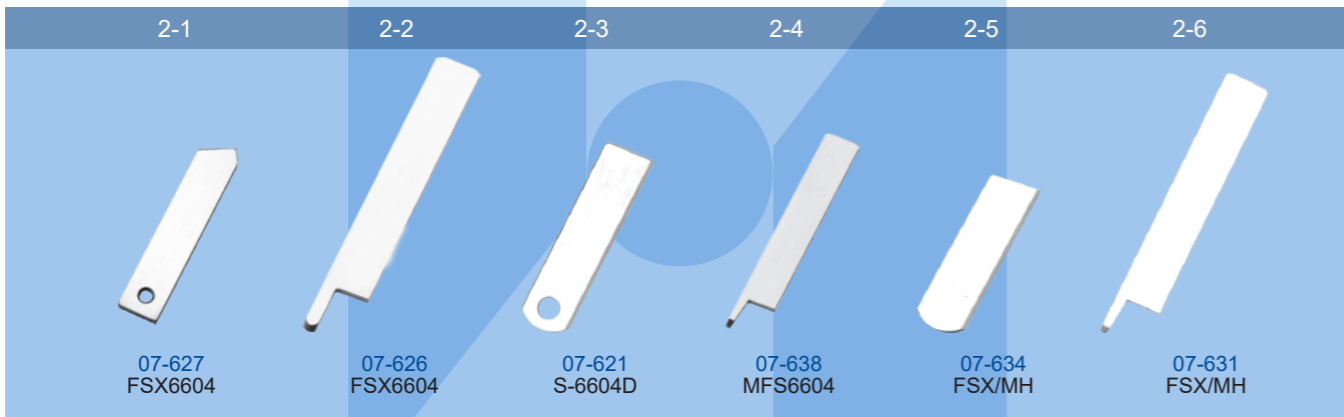
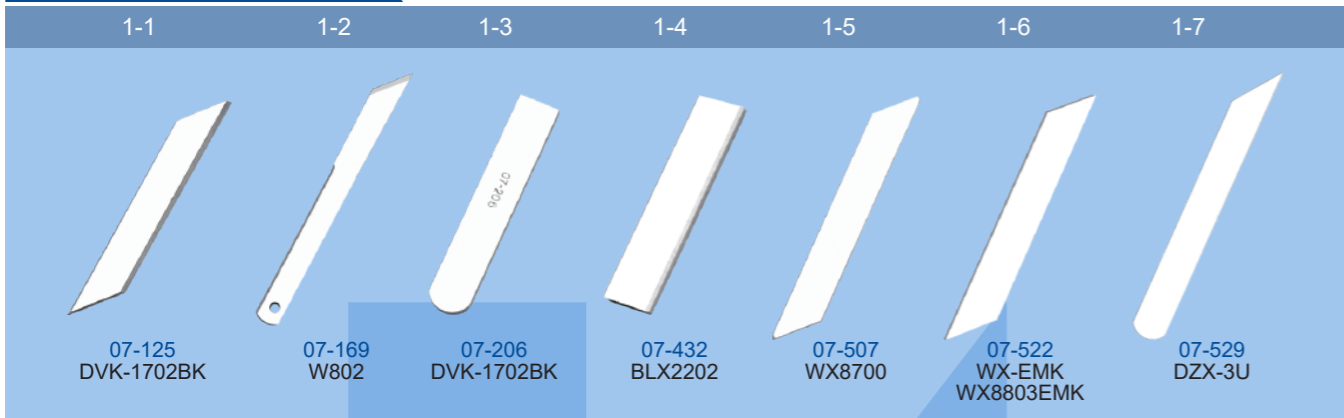

FOR KANSAI SPECIAL/关西

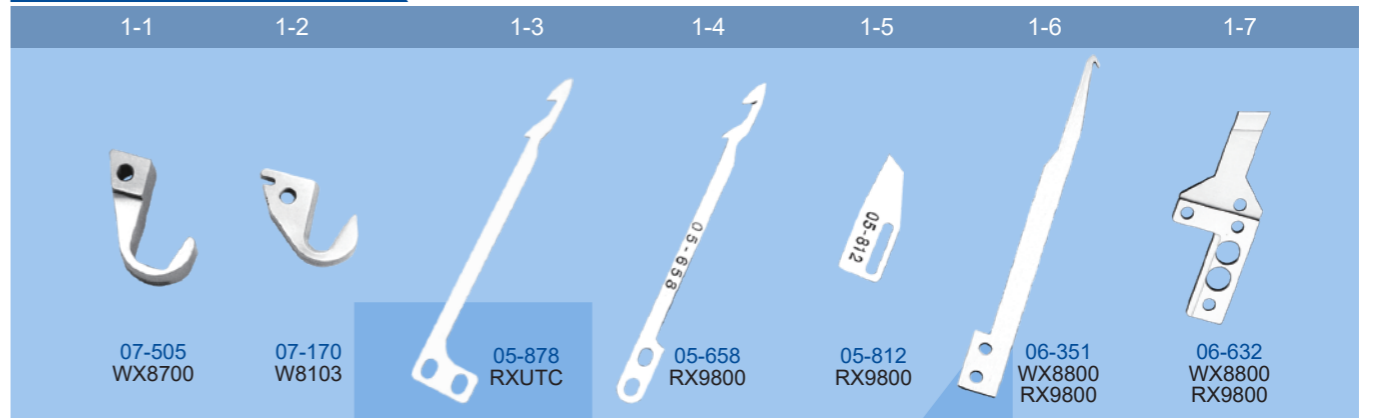

FOR KINGTEX/宝狮

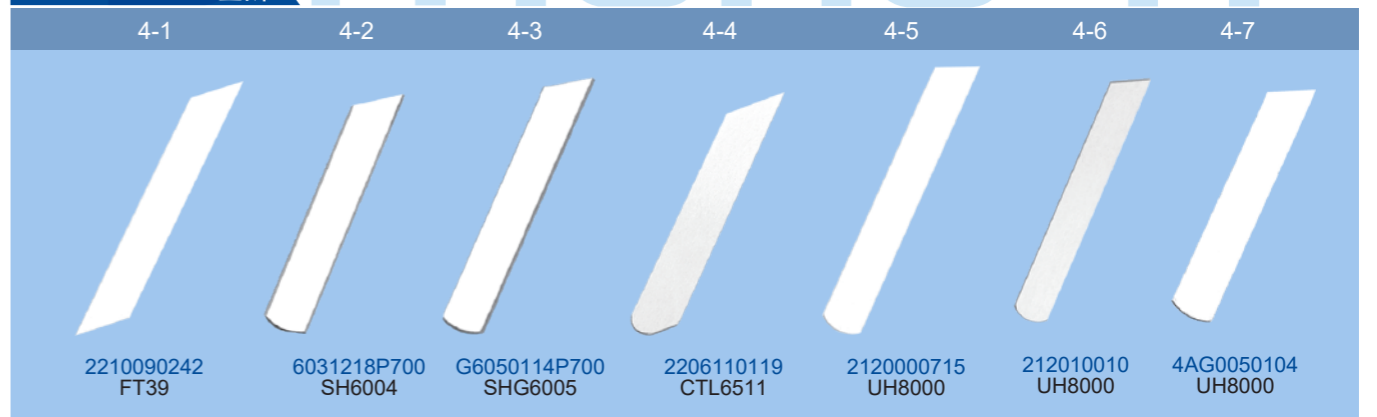

FOR KINGTEX/宝狮

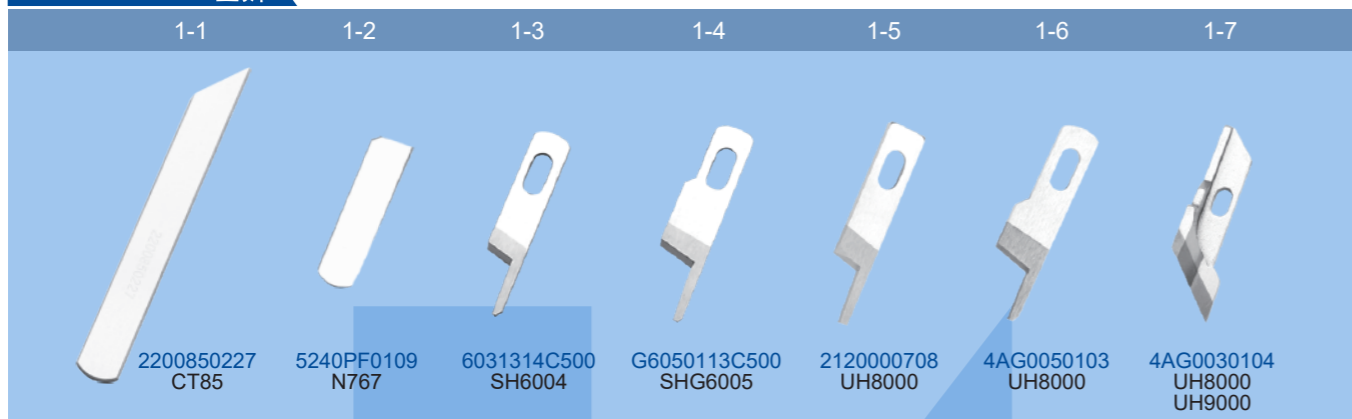

FOR MITSUBISHI/三菱



FOR MITSUBISHI/三菱

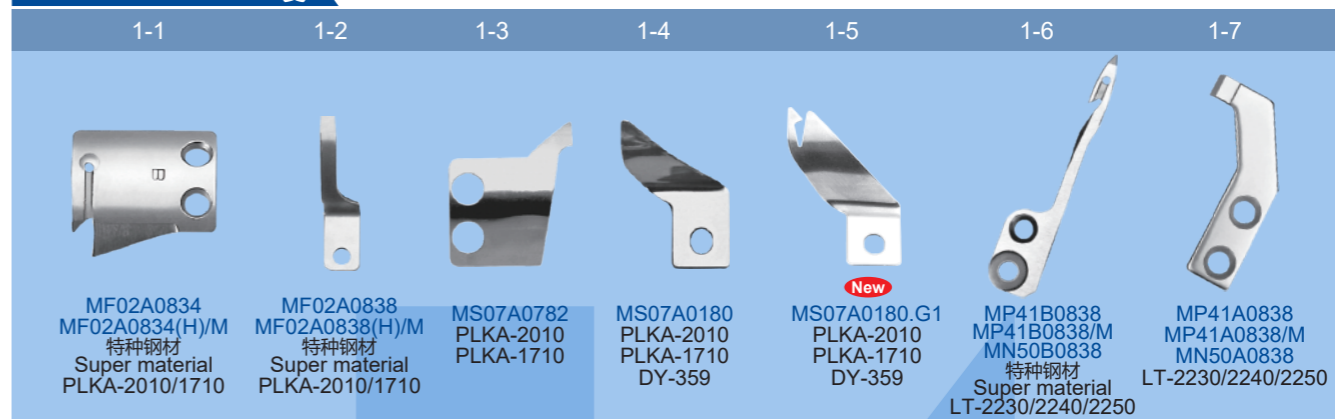

FOR MITSUBISHI/三菱

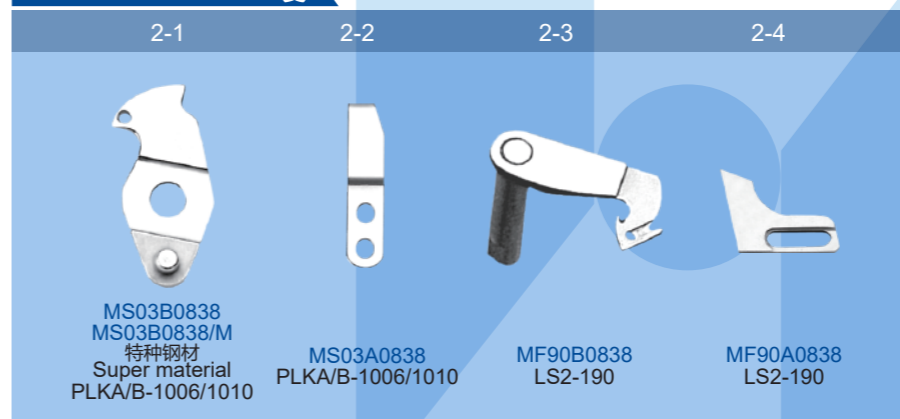

FOR MAUSER/毛瑟



FOR MERROW/梅罗

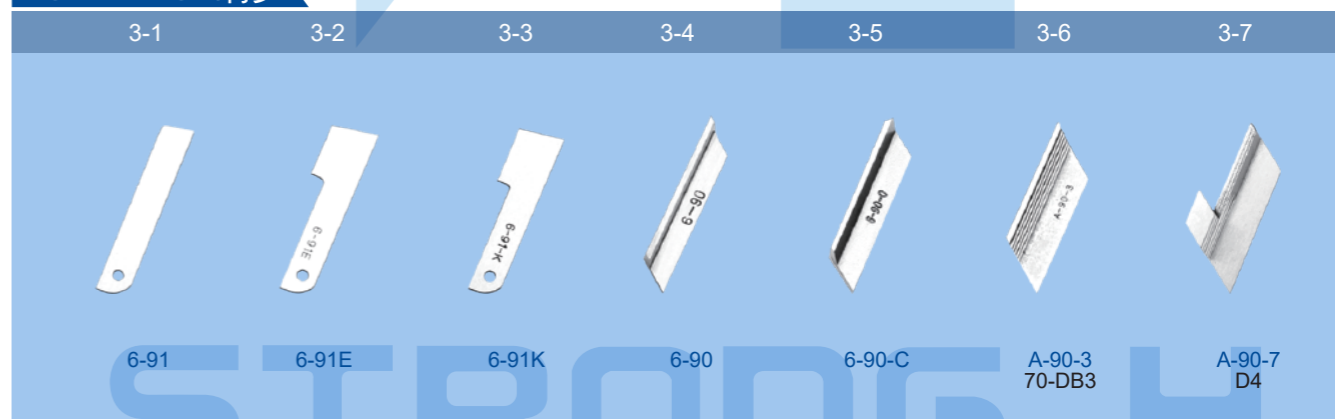



工业缝纫机刀类

KNIVES FOR INDUSTRIAL SEWING MACHINES

INDUSTRIAL SEWING MACHINES SPARE PARTS

FOR PFAFF/百福

1-1	1-2	1-3	1-4	1-5	1-6
91-264338-15 1481/1483/1487 2481/2483/5463/5483 5489/3566/3568 3588/3819/3822/3827	91-264240-05 1050/1180 951/953/563	91-014046-05 1050/1180	91-165505-05 333/335/337 461/463/469/481/483 487/489/1051/1053 1181/1183	91-500399-05	91-500397-05

2-1	2-2	2-3	2-4	2-5	2-6	2-7
91-263294-05 571/574	91-263139-05 571/574	91-263348-05 3734-12/31	95-774855-05 95-774855-05.L 加长(lengthen) 571/574/591	95-774853-05 571/574/591	95-774856-05(0.3mm) 95-774856-05-L(0.4mm) 95-774856-05-A(0.5mm) 571/574/591	95-774464-25 571/574/591

FOR PEGASUS/飞马

3-1	3-2	3-3	3-4	3-5	3-6	3-7
202893 202893[HSS] E/L52/R	202295 E/L52/R	CT202295 E/L52/R	2022950 M852-13	201127 E/L52/R(薄)	Ⓟ[HSS] R57	204161 L32/W562

4-1	4-2	4-3	4-4	4-5	4-6	4-7	4-8
2041610 M832-70	204161A W664-35	2A000600000 W3662-33	2A0008000009 WT264-35	137562 DC/DCP/DCM	200959 DCM-204	277009 EX5214	204351 L32-38

工业缝纫机刀类

KNIVES FOR INDUSTRIAL SEWING MACHINES

INDUSTRIAL SEWING MACHINES SPARE PARTS



FOR PEGASUS/飞马

1-1	1-2	1-3	1-4	1-5	1-6	1-7
205609 R57L	208393 M722	213108 E51-210	213108A EX5100	232026 S603	236608 236608[HSS] 236608.SH 特殊耐用钢 Super durable material FS601/FS603	236606 236606[HSS] 236606.SH 特殊耐用钢 Super durable material FS601/FS603

2-1	2-2	2-3	2-4	2-5	2-6	2-7
2A0081 FS700P	2A0082 FS700P	236606A FS700P	236618 236618[HSS] FS601/FS603	138559 DCP-101	200971 DCM-204	205607 E32L

3-1	3-2	3-3	3-4	3-5	3-6	3-7
202527A L32-38	202570 E/L/R	201121A E52/L52/R53 EX3200/EX5200	201121ANS E52-131	201121A0 M800	205890 EX3200/5200	277000 EX5214

4-1	4-2	4-3	4-4	4-5	4-6	4-7	4-8
210755 EX3200 EX5200	211662 EX5214H	211662A EX5214H	New 2A0010000009 EX3200	306394 W500/W600	257573 W664-05	257573A W664-33	257574 W664-35

FOR PEGASUS/飞马

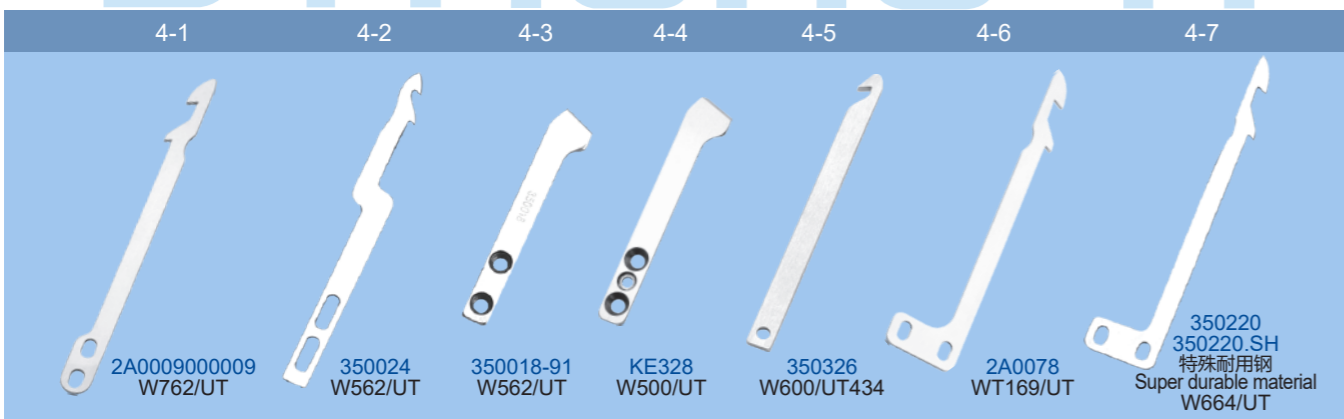
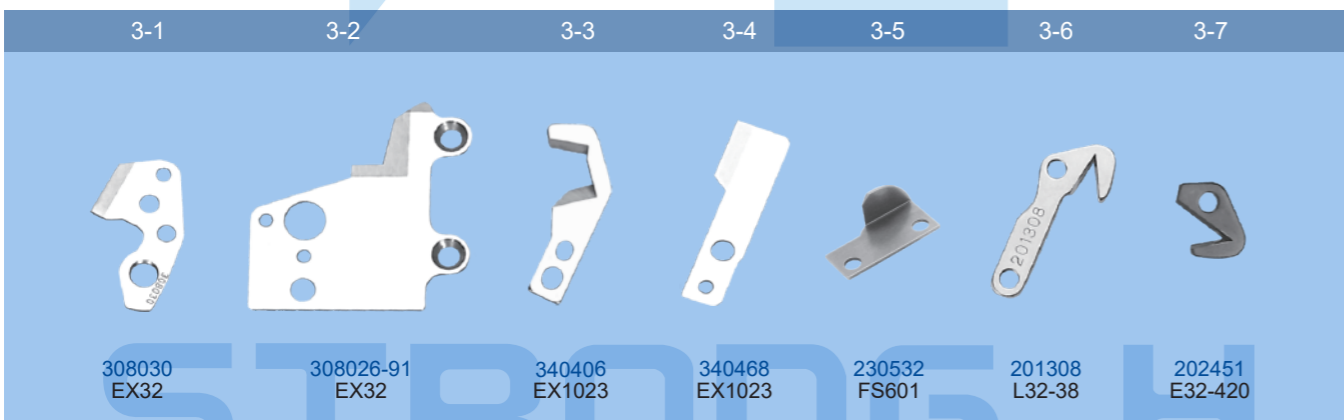
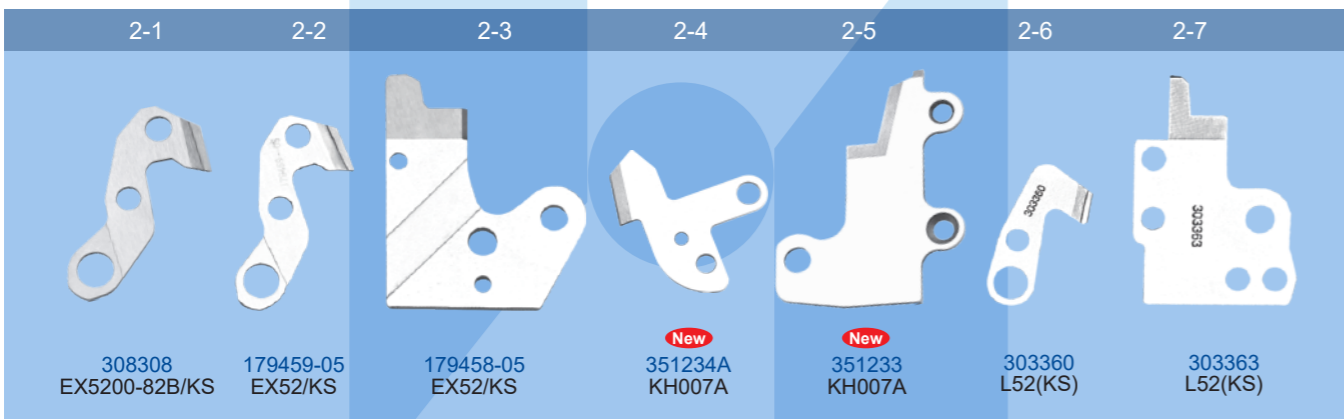
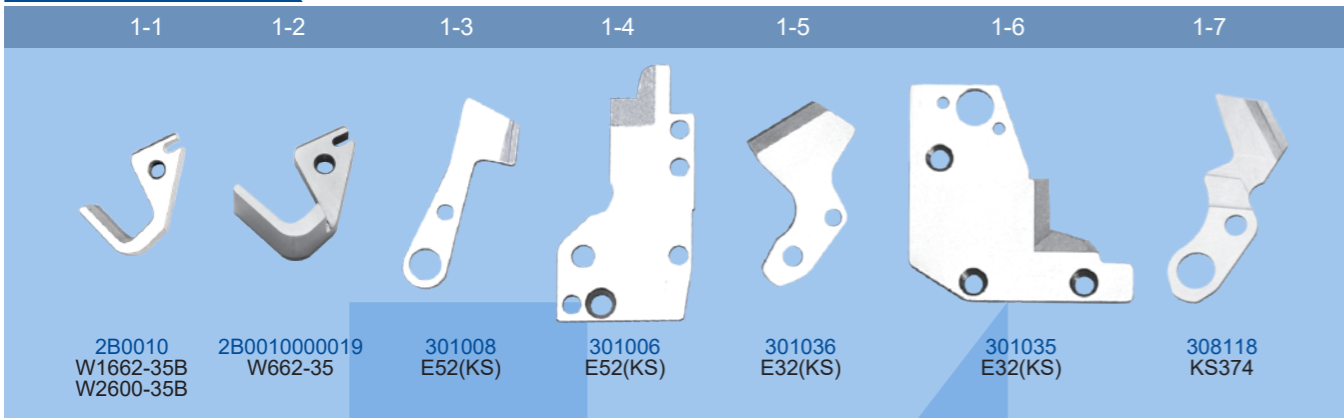



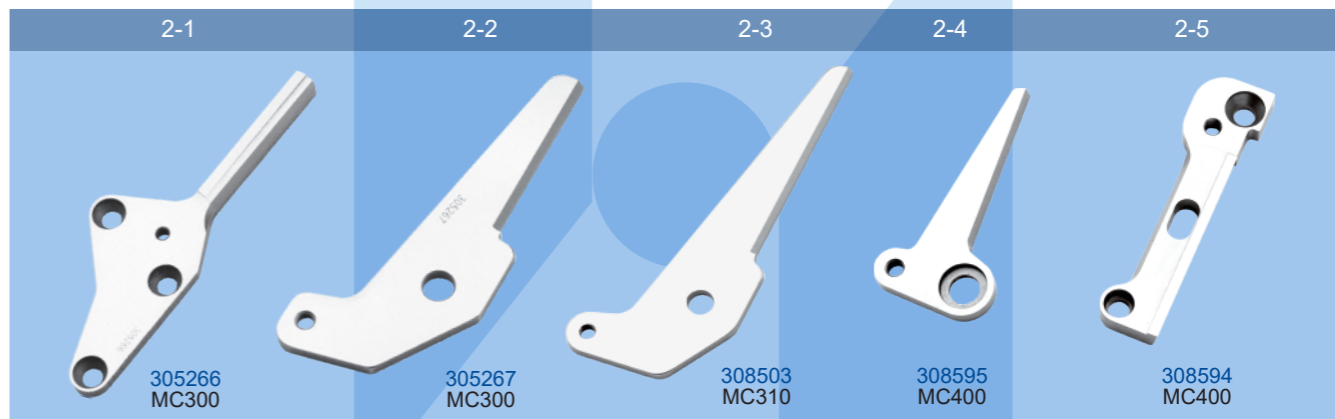
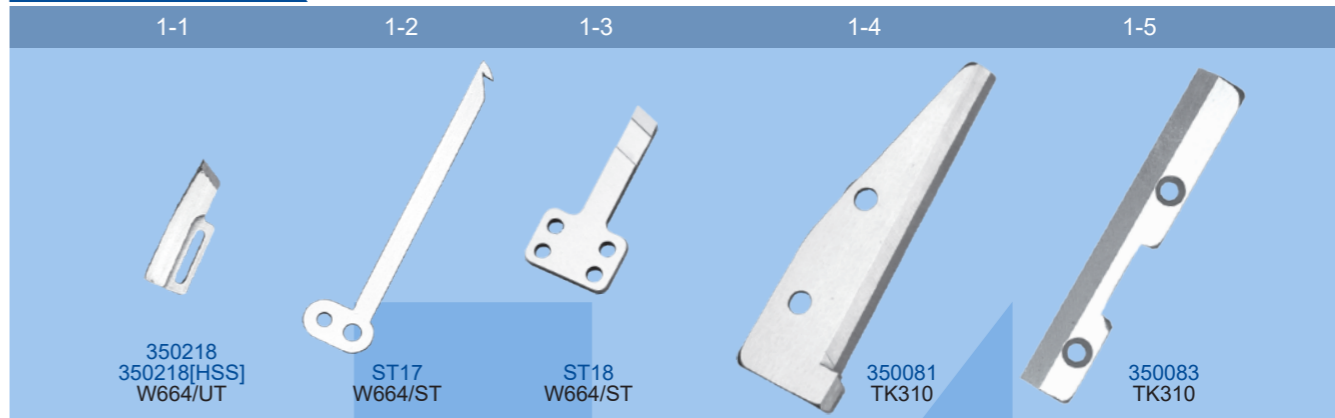



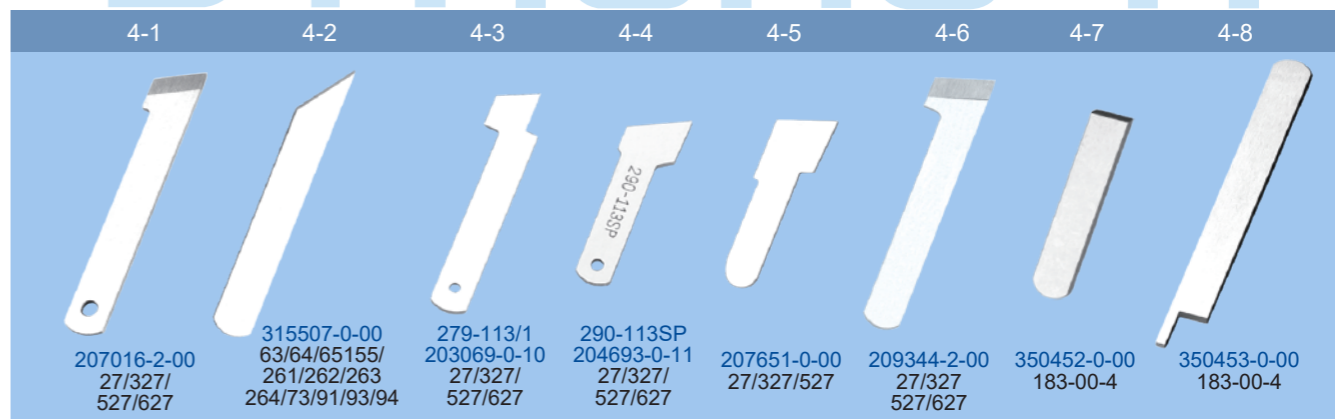
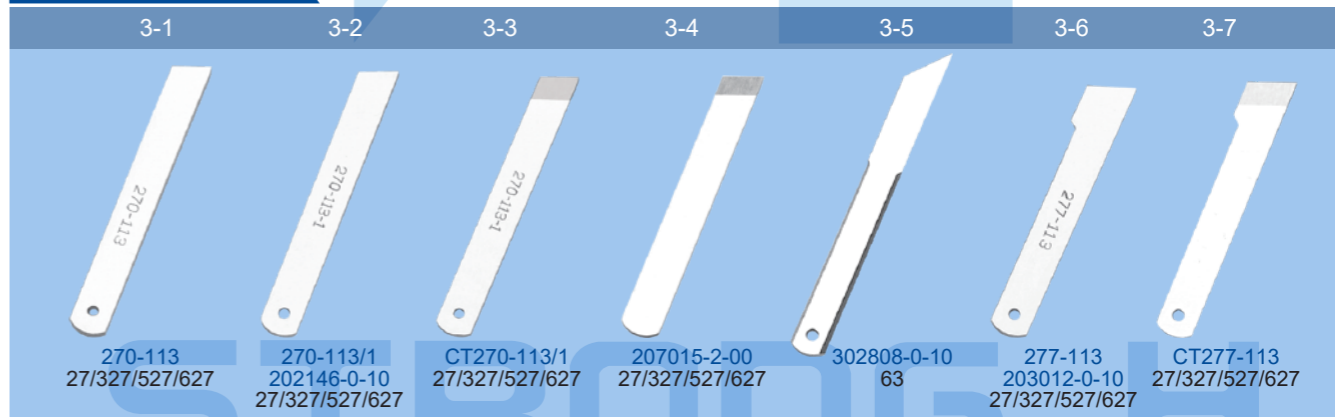







FOR PEGASUS/飞马

































FOR RIMOLDI/利满地



FOR RIMOLDI/利满地

1-1  CT290-113 207020-2-00 207020-2-01 27/327/527/627	1-2  290-113 204693-0-10 27/327/527/627	1-3  270-112 202142-0-10 27/327/527/627	1-4  290-112 203783-0-10 27/327/527/627	1-5  CT276B-112 202932-0-10 27/327/527/627	1-6  279-112 203066-0-10 27/327/527/627	1-7  209348-0-10 27/327/527/627
2-1  209356-0-00 27/327/527/627	2-2  270-112/1 202143-0-10 27/327/527/627	2-3  277-112 203010-0-10 27/327/527/627	2-4  203759-0-10 27/327/527/627	2-5  209350-0-00 209350-0-10 27/327/527/627	2-6  209341-0-00 209341-0-10 27/327/527/627	2-7  CT270-112 207000-2-00 27/327/527/627
3-1  209340-2-01 27/327/527/627	3-2  CT290-112 207003-2-00 27/327/527/627	3-3  209347-2-01 27/327/527/627	3-4  209351-2-01 27/327/527/627	3-5  CT277-112 207002-2-00 27/327/527/627	3-6  207004-2-00 27/327/527/627	3-7  209342-2-01 27/327/527/627
4-1  209348-0-00 27/327/527/627	4-2  209352-0-00 27/327/527/627	4-3  302807-0-10 261/263/264	4-4  302865-0-11 261/263/264	4-5  202194-0-11 27/327/527/627	4-6  928531-2-00 27/28/29	4-7  928530-2-00 27/28/29

FOR SIRUBA/银箭

1-1  CRL09J C007J	1-2  CR336 C007	1-3  KR35 747/700K	1-4  KR35C 757	1-5  FBQ30 F007E/FBQ	1-6  FR40 HF008/FBQ	1-7  FR40D F007E/FBQ	1-8  FR40K F007K/FR
2-1  FR40J F007J/FR	2-2  KR55 700FS	2-3  KR23 747/700K	2-4  KR23A 747	2-5  KR23C 757	2-6  AN02 747K/AN	2-7  AN12 747K/AN	2-8  AN13 F007
3-1  FR34B HF008/FBQ	3-2  FR34 HF008/FBQ	3-3  FR134 F007J	3-4  FR34H F007	3-5  CR26J C007J	3-6  CR26H C007E/CRL	3-7  CRL03 C007E/CRL	3-8  CRL03H C007H/CRL
4-1  CRL03J C007E/CRL	4-2  CR26 C007	4-3  CRL103 C007J	4-4  CRL104 C007J/C007JD	4-5  CRL04J C007E/CRL	4-6  CRL04H C007H	4-7  CRL204 F007	

FOR SIRUBA/银箭

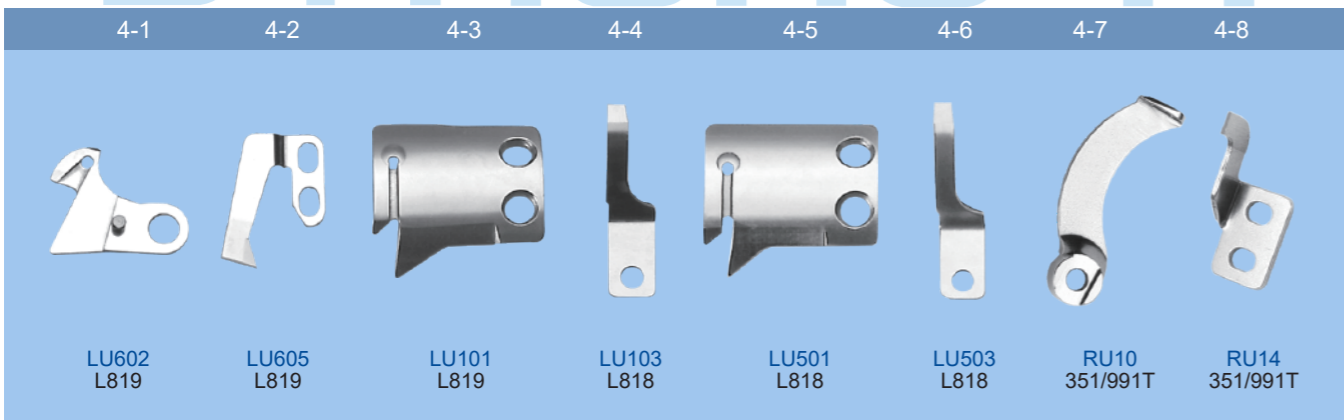
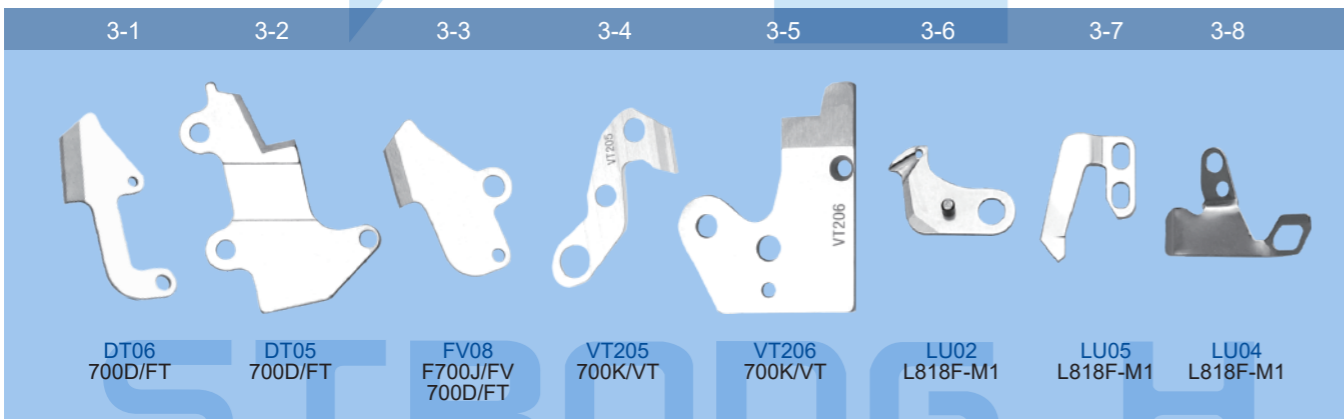
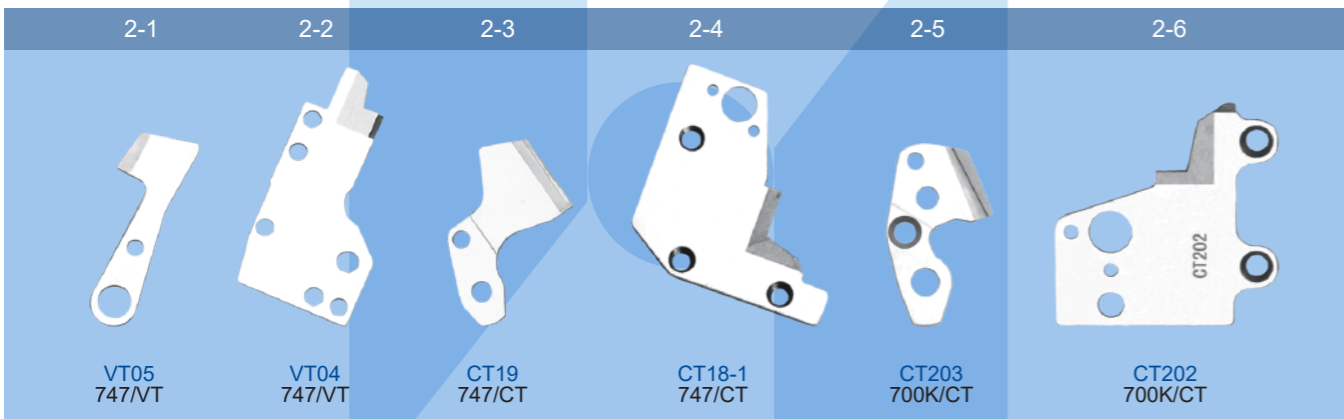
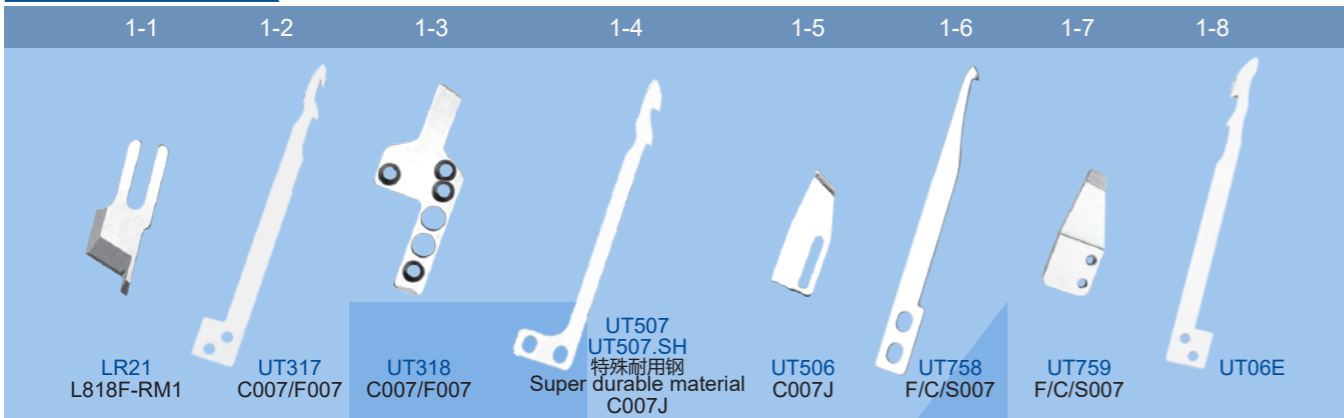

FOR SIRUBA/银箭

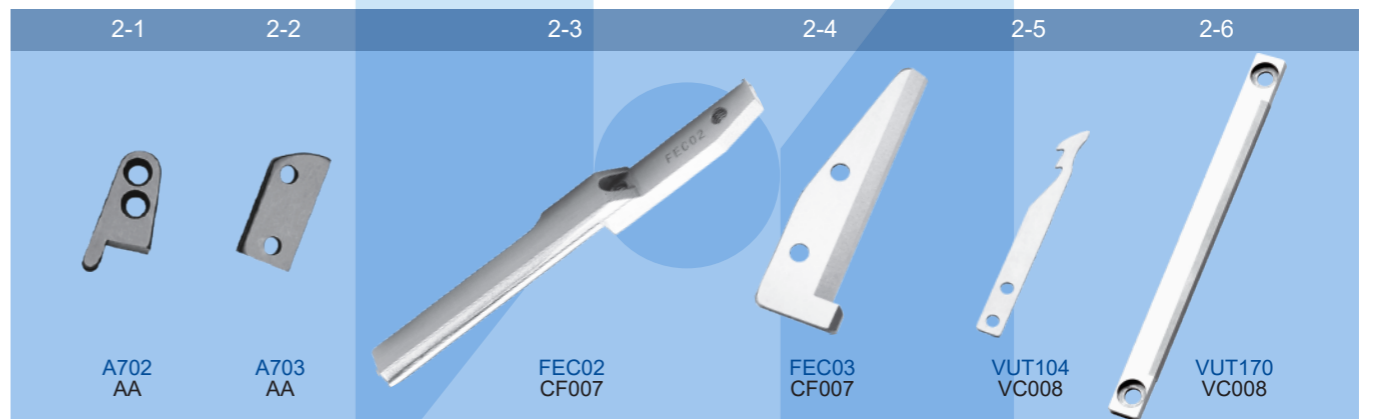

FOR SUN STAR/日星

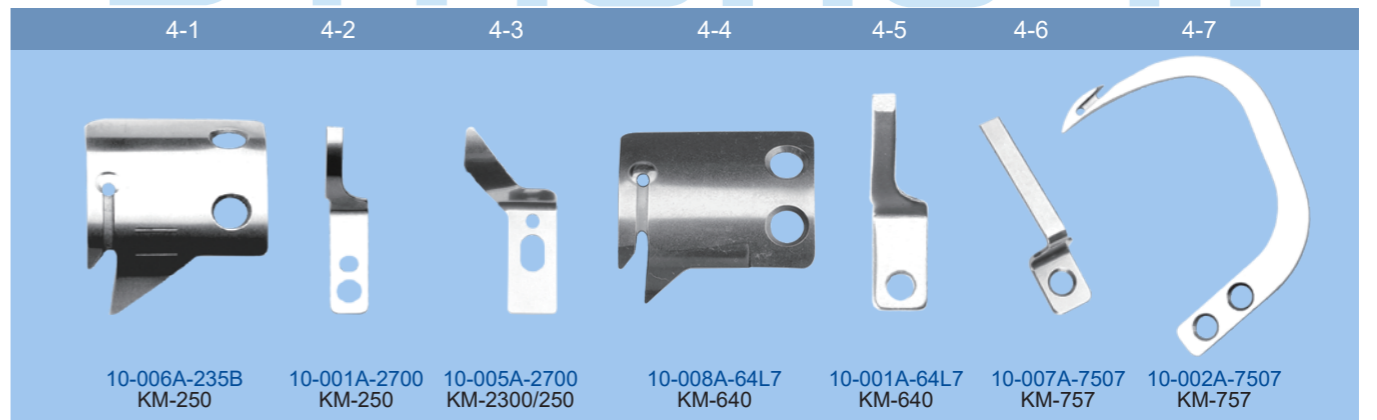



工业缝纫机刀类

KNIVES FOR INDUSTRIAL SEWING MACHINES

INDUSTRIAL SEWING MACHINES SPARE PARTS

FOR SUN STAR/日星

1-1	1-2	1-3	1-4	1-5	1-6	1-7	1-8
10-006A-120H SPS/A-B1201	10-001A-120H SPS/A-B1201	10S047S-306H SPS/A-1306-HS	10S045S-306H SPS/B-1306-HS	GP-001548-00 SC7300	GP-001544-00 SC7300	10-011A-8677 KM957-7 KM967-7	10-002A-8677 KM957-7 KM967-7

FOR SINGER/胜家

2-1	2-2	2-3	2-4	2-5	2-6	2-7	2-8
42309 81	42305 81	412749 14U	410295 14U	164728 246.460	550449 14SH654	412585 14U	164550 246

3-1	3-2	3-3	3-4	3-5	3-6	3-7	3-8
548845 299U.T.T	548851 299U123	253775 299U123	548865 299U123	253647 299U123	544533 299U	411088 457U	502670 457G 457U

FOR REECE/利是

4-1	4-2	4-3	4-4	4-5	4-6	4-7	4-8
540741 591	540760 591	REECE38	REECE38-1	46-1001-5-289 38	46-1125-5-000 45 REECE 46	157	10-1197-1 104

工业缝纫机刀类

KNIVES FOR INDUSTRIAL SEWING MACHINES

INDUSTRIAL SEWING MACHINES SPARE PARTS



FOR SHING LING/星菱

1-1	1-2	1-3	1-4	1-5	1-6	1-7	1-8
FB15 FW-777	VH50 G888	D1737 FG-797	25-14 VG888A	17-58 VG888A	17-23 VG888A	J2213[HSS] SL-700	J1037[HSS] SL-700

FOR SHING RAY/星锐

2-1	2-2	2-3	2-4	2-5	2-6	2-7
P16-9 FW-787	P16-26 FW-787	P17-35 FW-787	P17-22 FW-787	P8-50 FW-787	KE1984 FW-787	KE1985 FW-787

3-1	3-2	3-3	3-4	3-5	3-6	3-7
KE2266 FW-787	KE1697 FW-720	KE1698 FW-720	K6-29A K6-29A[HSS] K6-29A.SH FW-740	K7-44A K7-44A[HSS] K7-44A.SH FW-740	K26-17 SE2-K26-17[HSS] K26-17[K] SE2-K26-17[K][HSS] FW-740	K26-37 SE2-K26-37[HSS] K26-37[K] SE2-K26-37[K][HSS] FW-740

4-1	4-2	4-3	4-4
New KE1599 FW-787	New KE1600 FW-787	New S13-6 FW-780	New S13-8 FW-780



工业缝纫机刀类

KNIVES FOR INDUSTRIAL SEWING MACHINES

INDUSTRIAL SEWING MACHINES SPARE PARTS

FOR TOYOTA/丰田

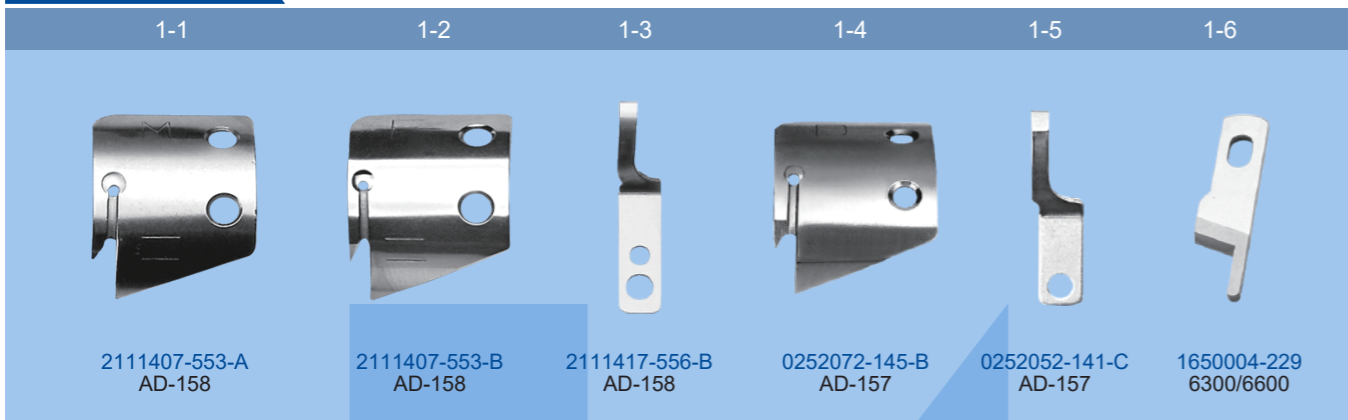

FOR UNION SPECIAL/友联

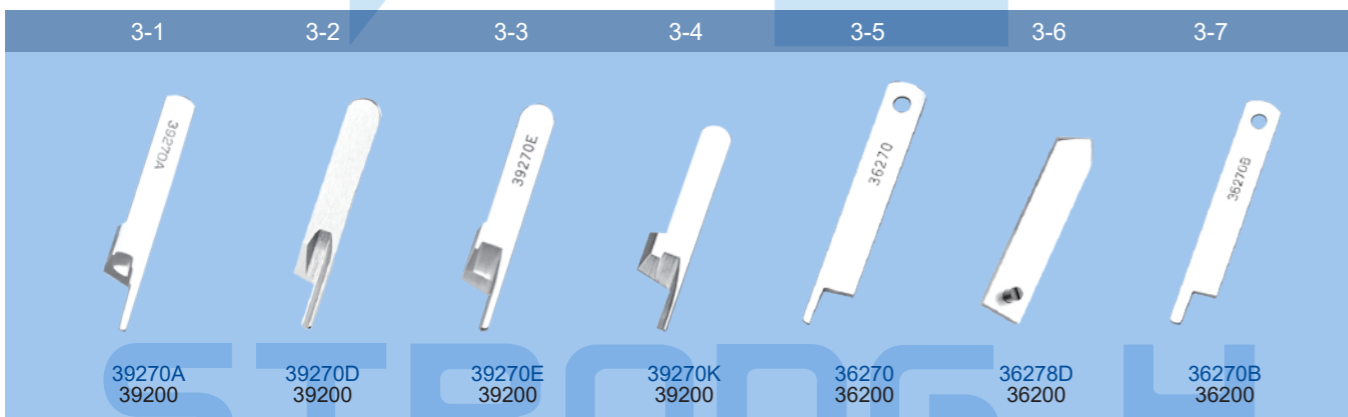
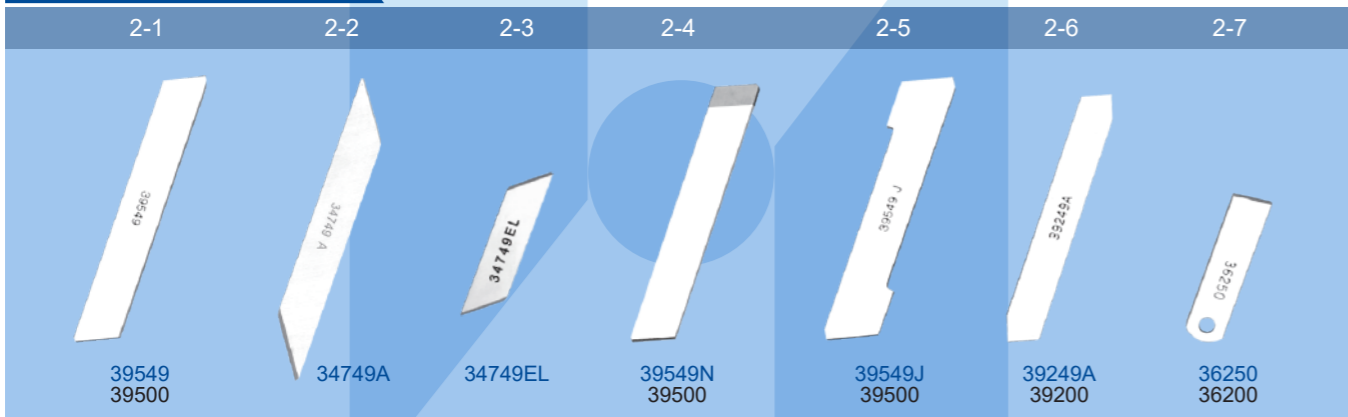

FOR YAMATO/大和

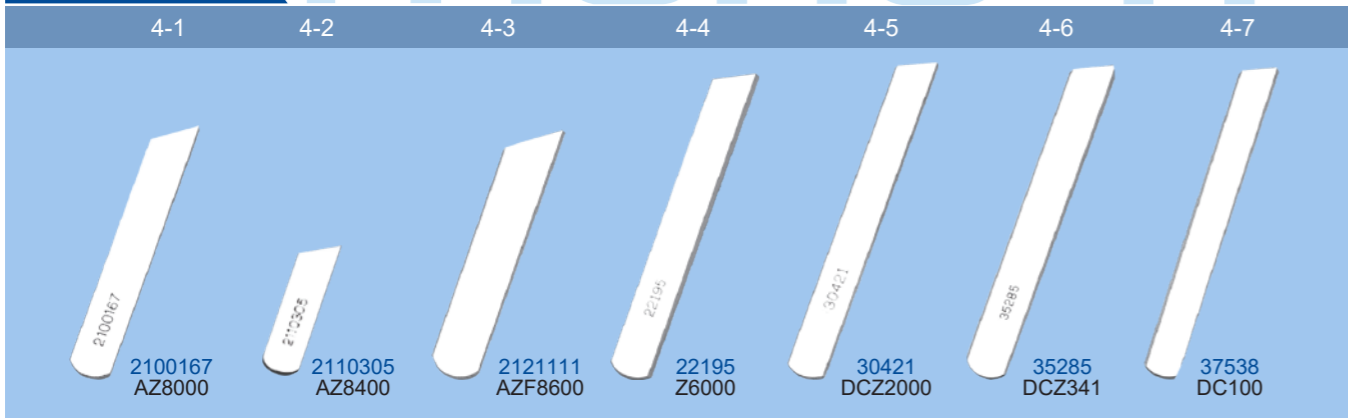

工业缝纫机刀类

KNIVES FOR INDUSTRIAL SEWING MACHINES

INDUSTRIAL SEWING MACHINES SPARE PARTS



FOR YAMATO/大和

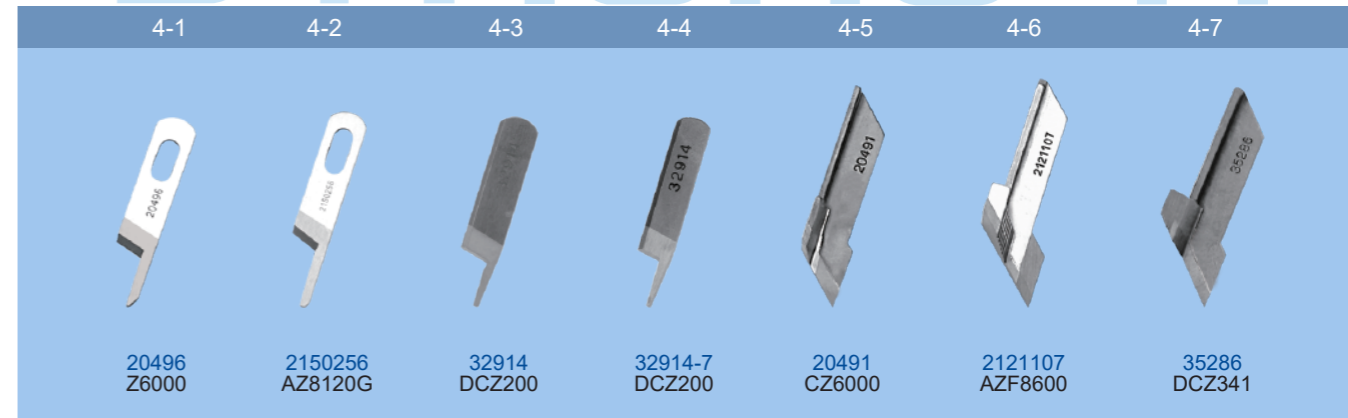
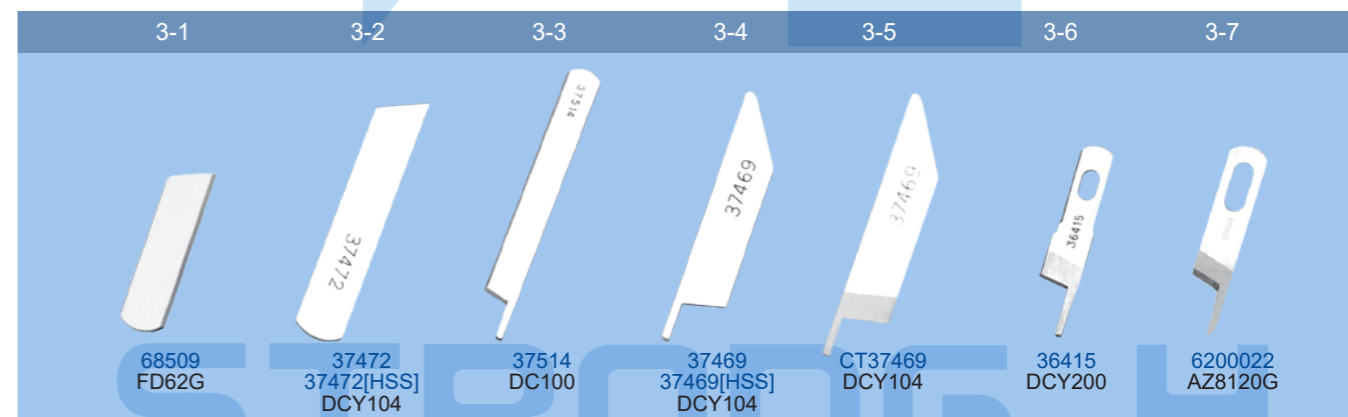
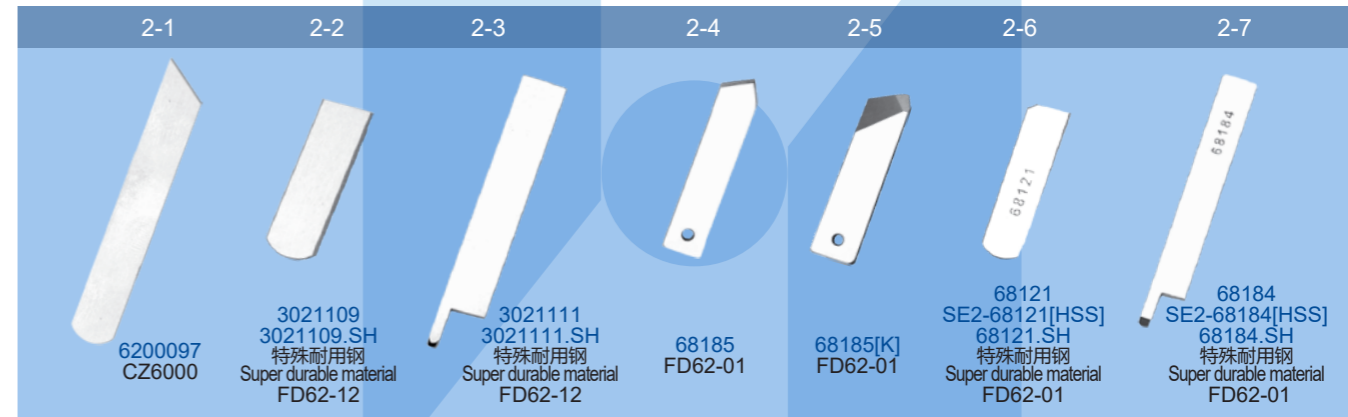
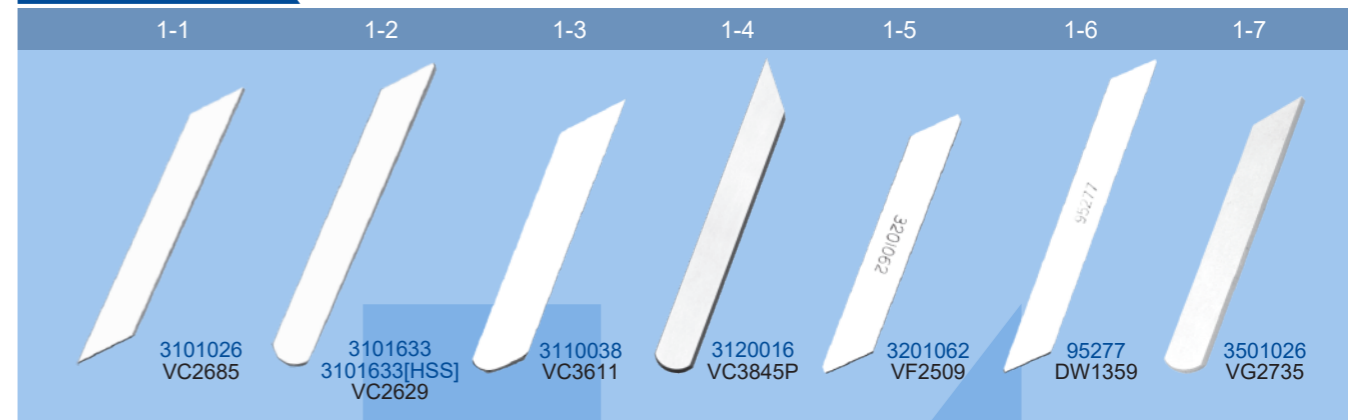



工业缝纫机刀类

KNIVES FOR INDUSTRIAL SEWING MACHINES

INDUSTRIAL SEWING MACHINES SPARE PARTS

FOR YAMATO/大和

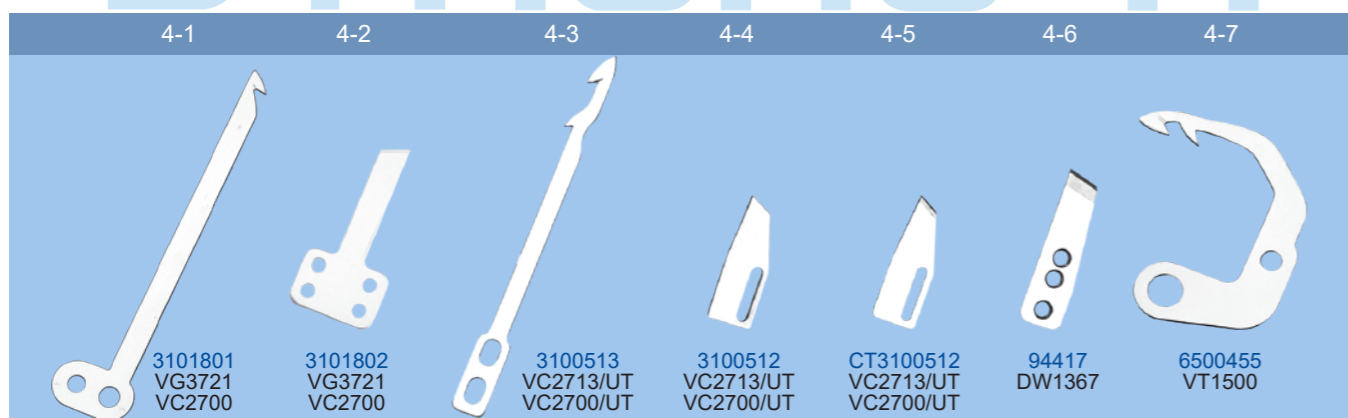
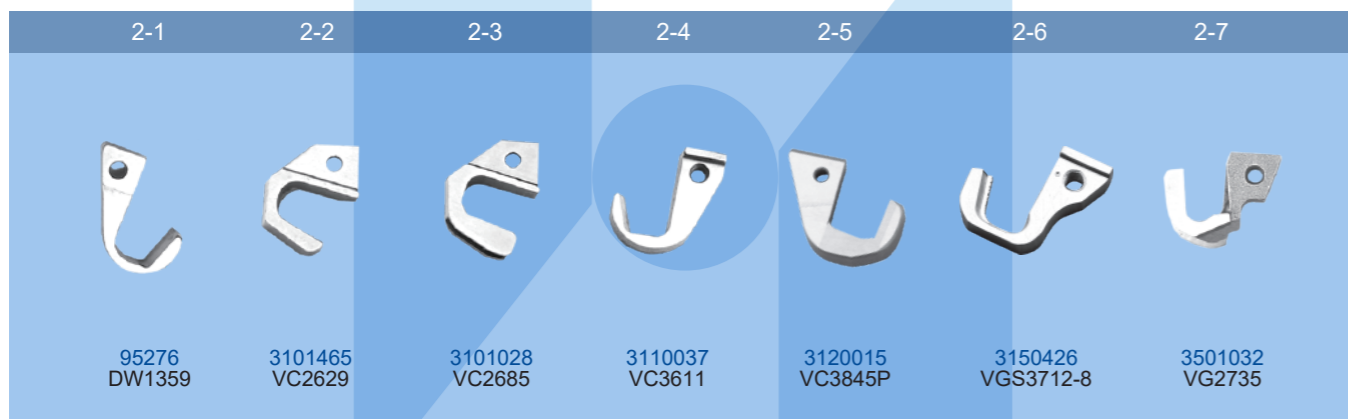
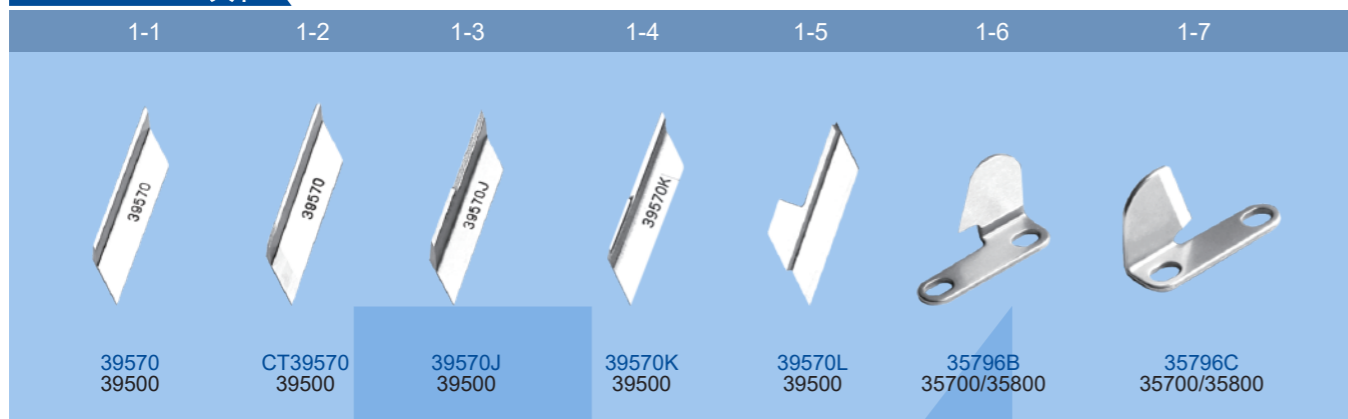

工业缝纫机刀类

KNIVES FOR INDUSTRIAL SEWING MACHINES

INDUSTRIAL SEWING MACHINES SPARE PARTS



FOR YAMATO/大和

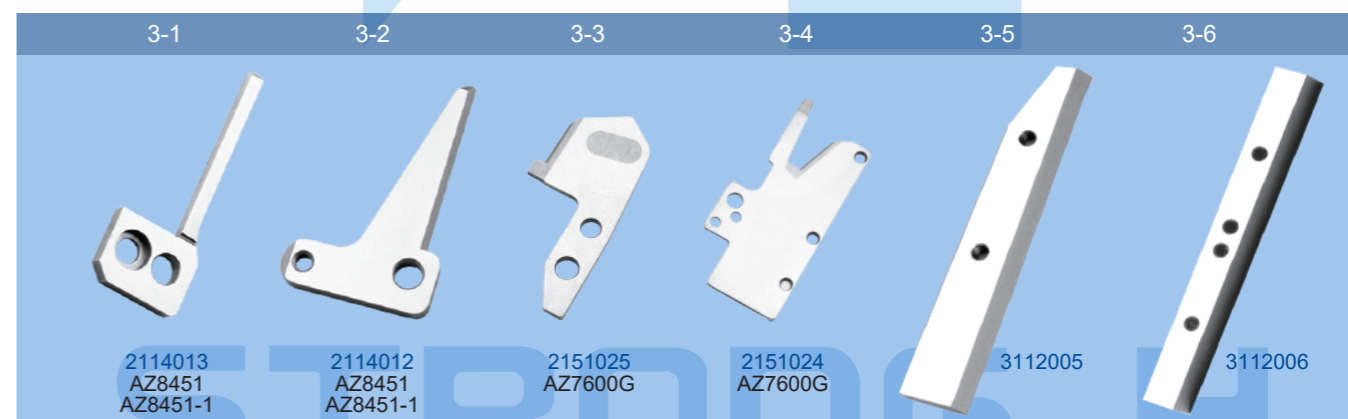
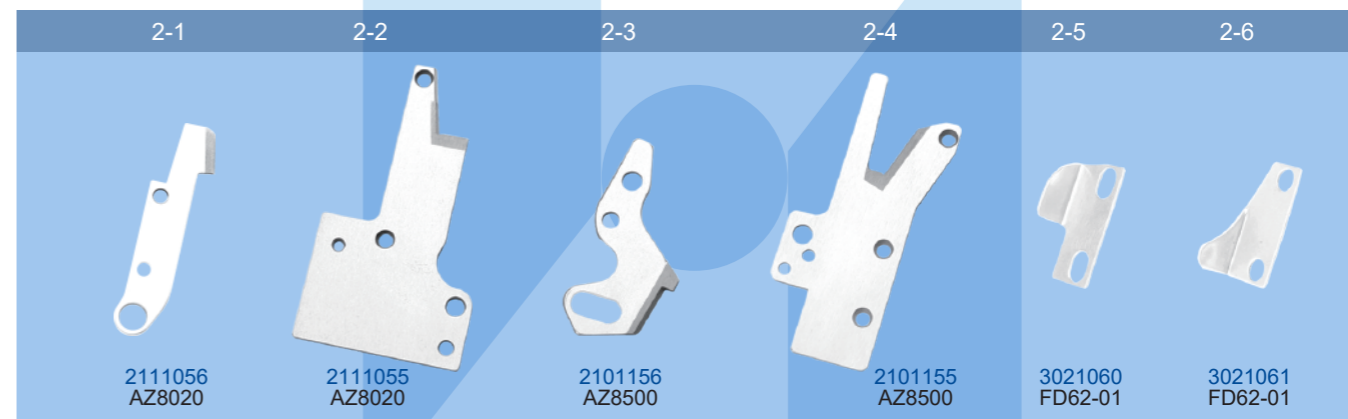
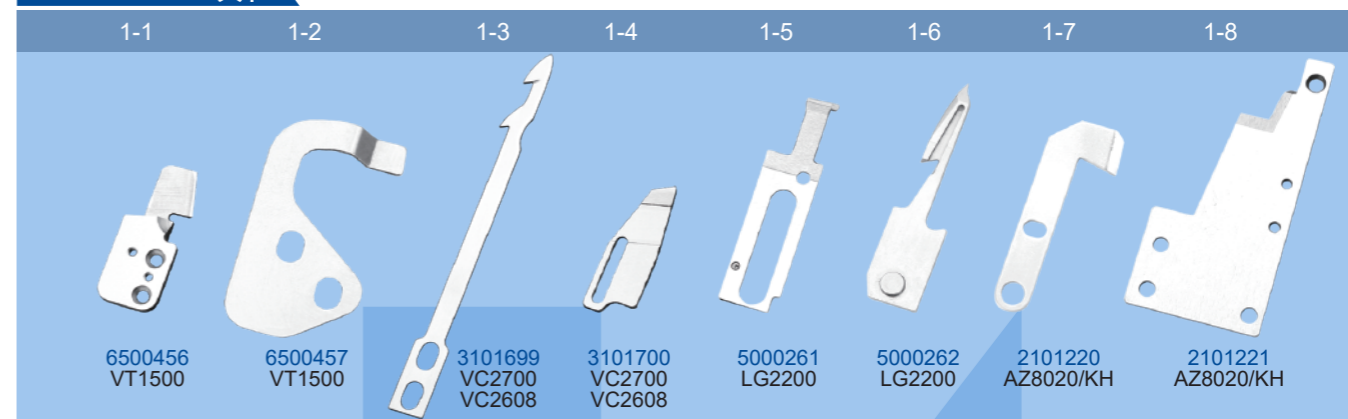

FOR TAG SEWING CUTTER/吊牌切钉刀



FOR GOLDEN WHEEL/金轮





工业缝纫机刀类

KNIVES FOR INDUSTRIAL SEWING MACHINES

INDUSTRIAL SEWING MACHINES SPARE PARTS

FOR YAO HAN/耀翰

FOR NEWLONG/纽朗

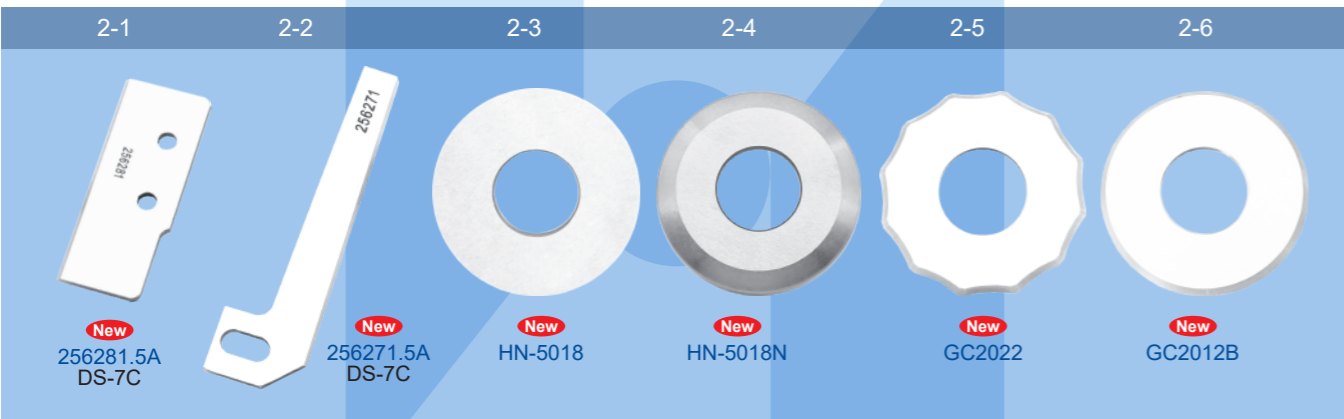
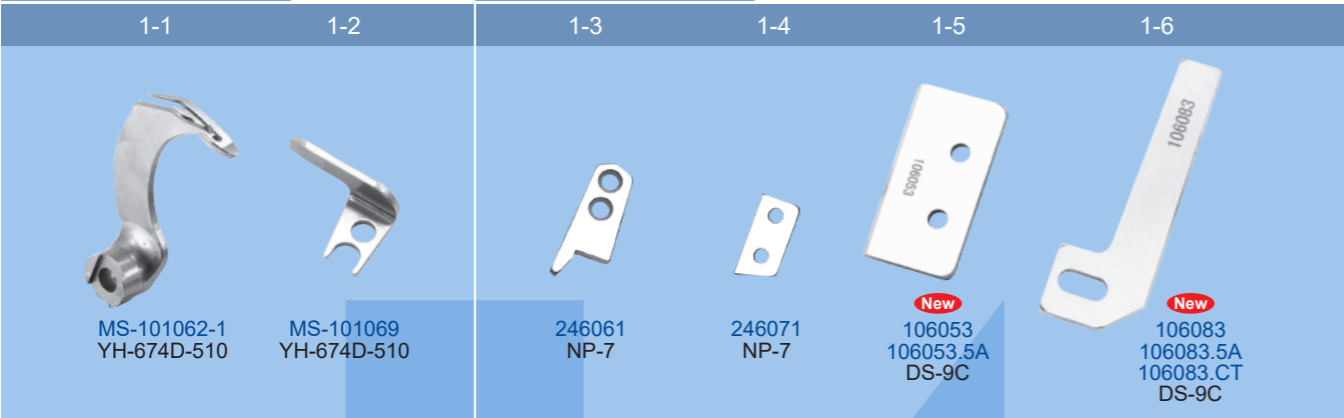

FOR OTHERS/其他

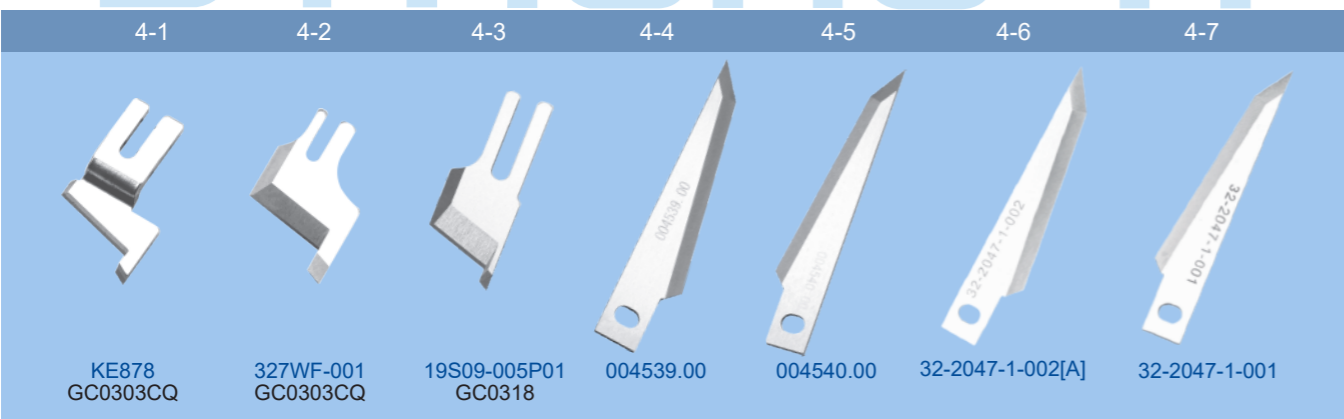
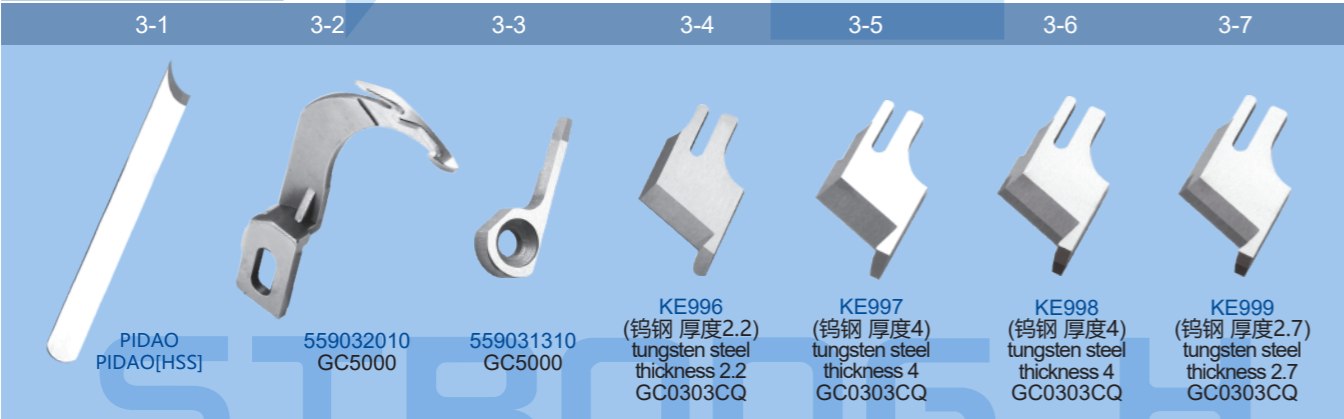

工业缝纫机刀类

KNIVES FOR INDUSTRIAL SEWING MACHINES

INDUSTRIAL SEWING MACHINES SPARE PARTS



FOR OTHERS/其他

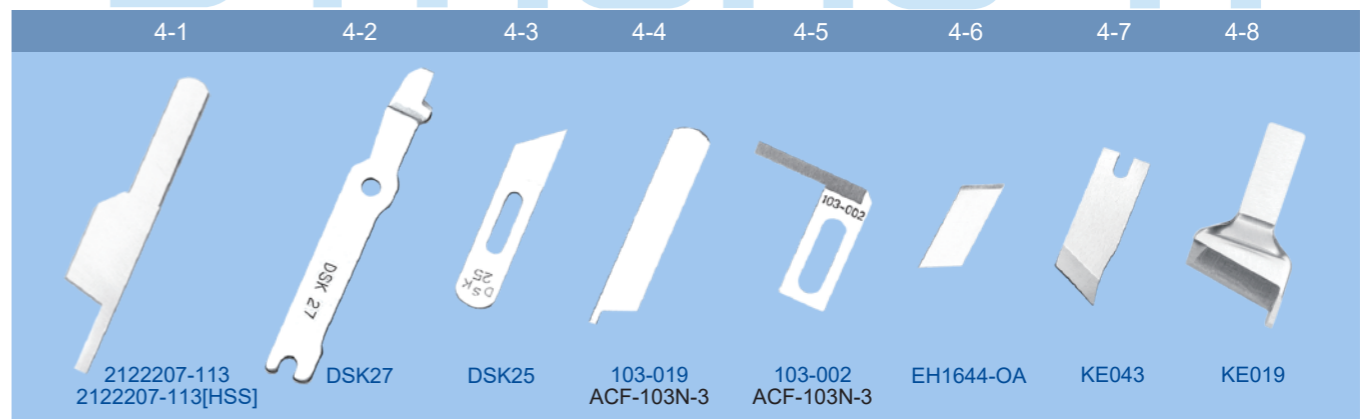
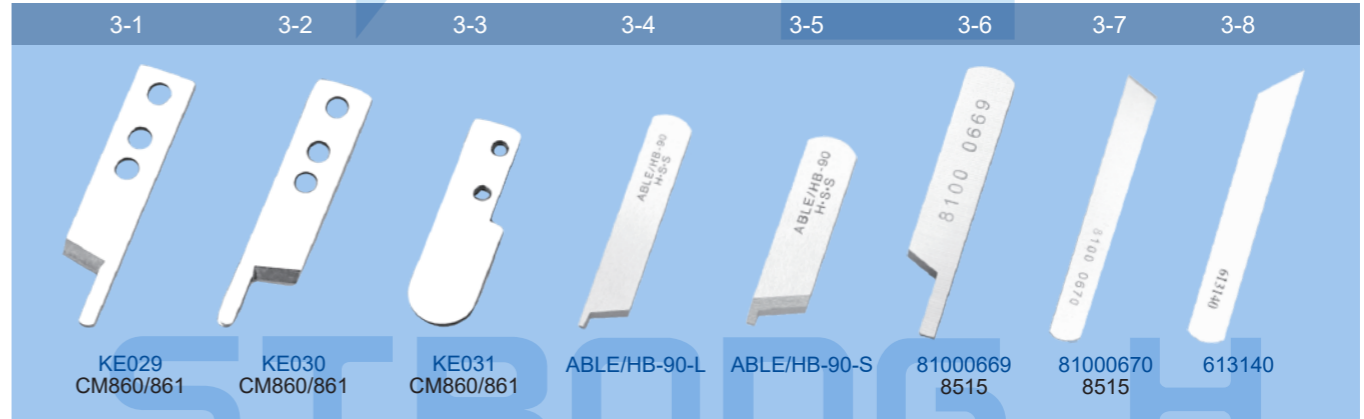
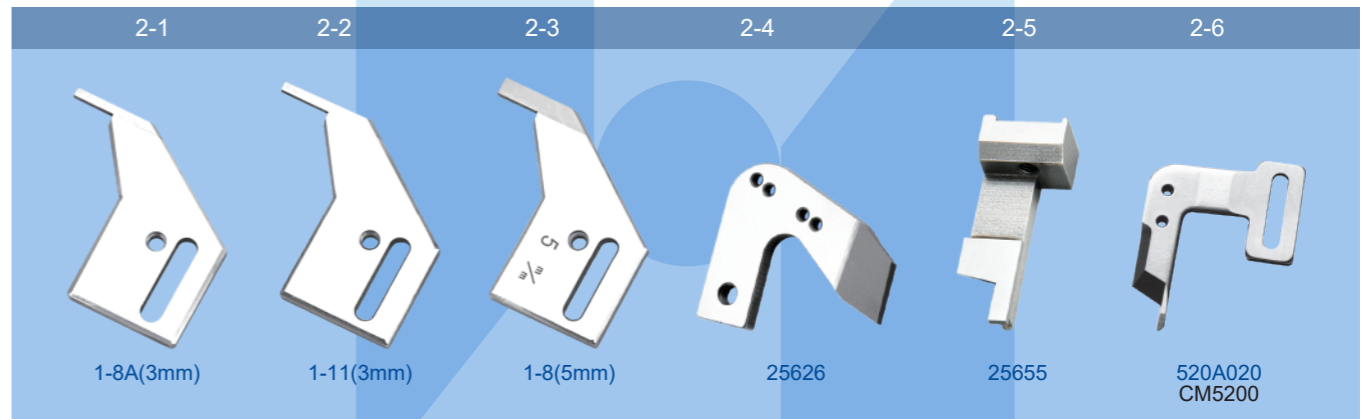
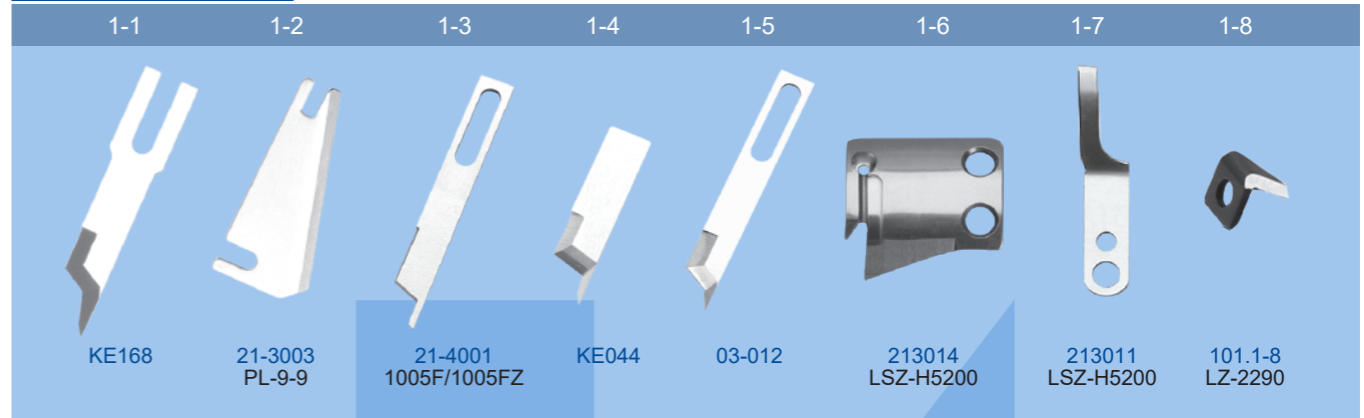



工业缝纫机刀类

KNIVES FOR INDUSTRIAL SEWING MACHINES

INDUSTRIAL SEWING MACHINES SPARE PARTS

FOR OTHERS/其他

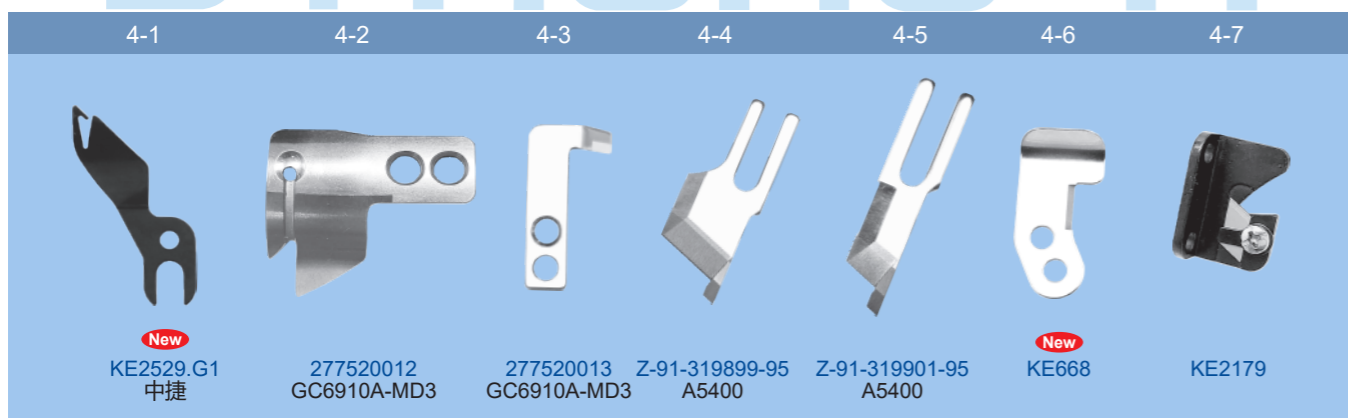
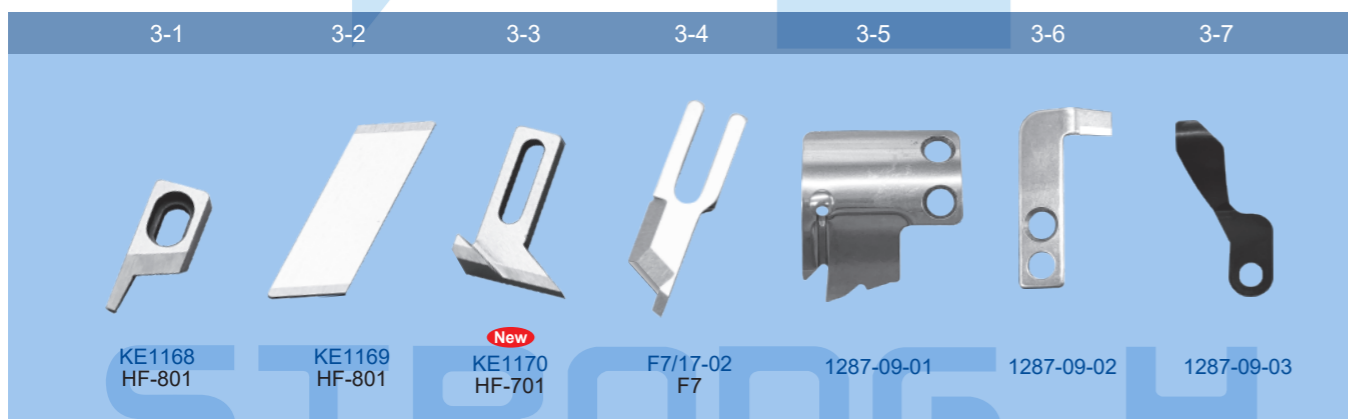
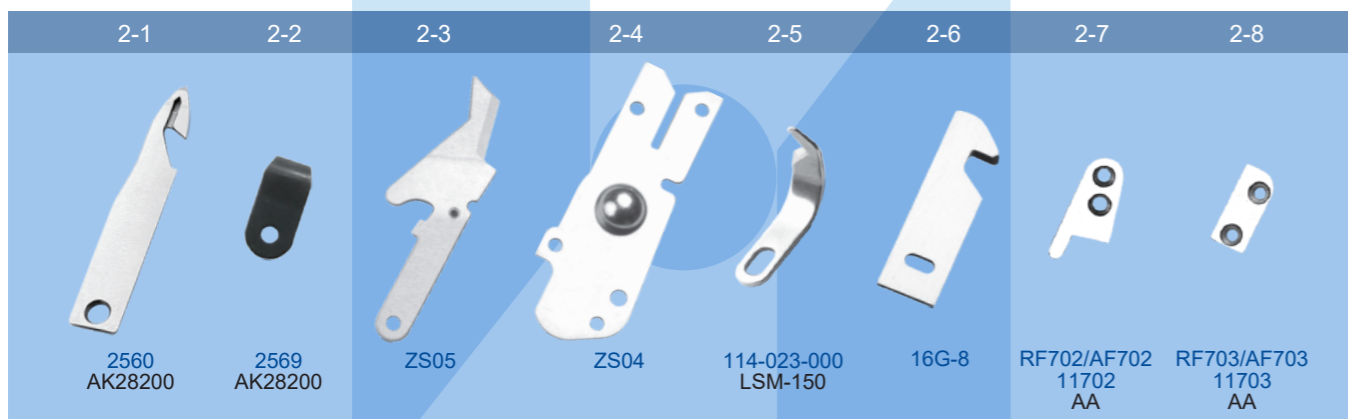
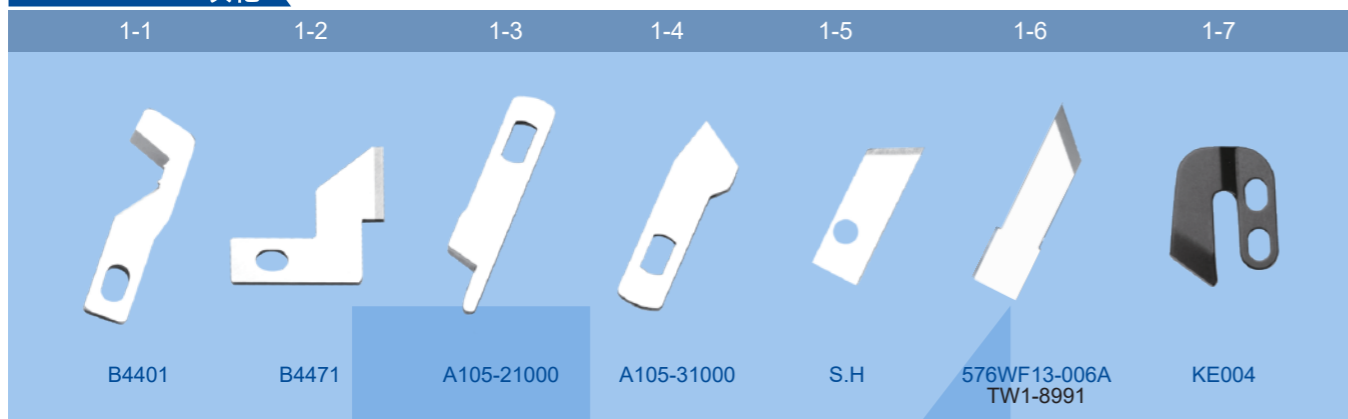

工业缝纫机刀类

KNIVES FOR INDUSTRIAL SEWING MACHINES

INDUSTRIAL SEWING MACHINES SPARE PARTS

FOR OTHERS/其他

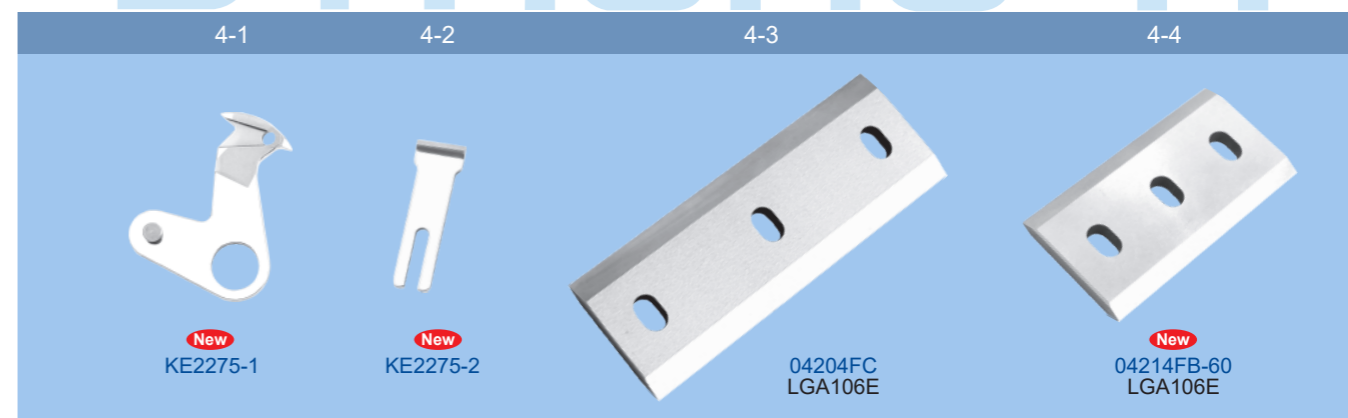
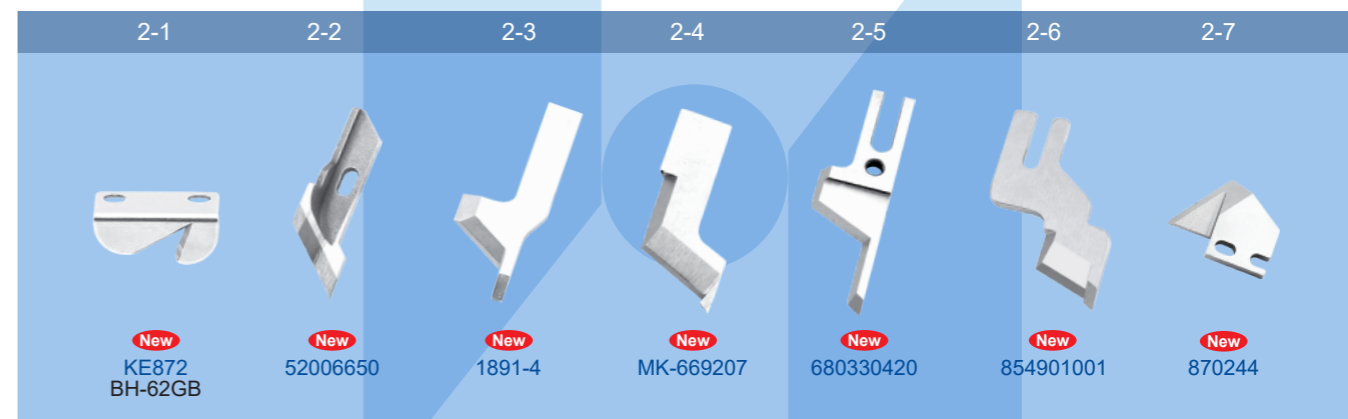
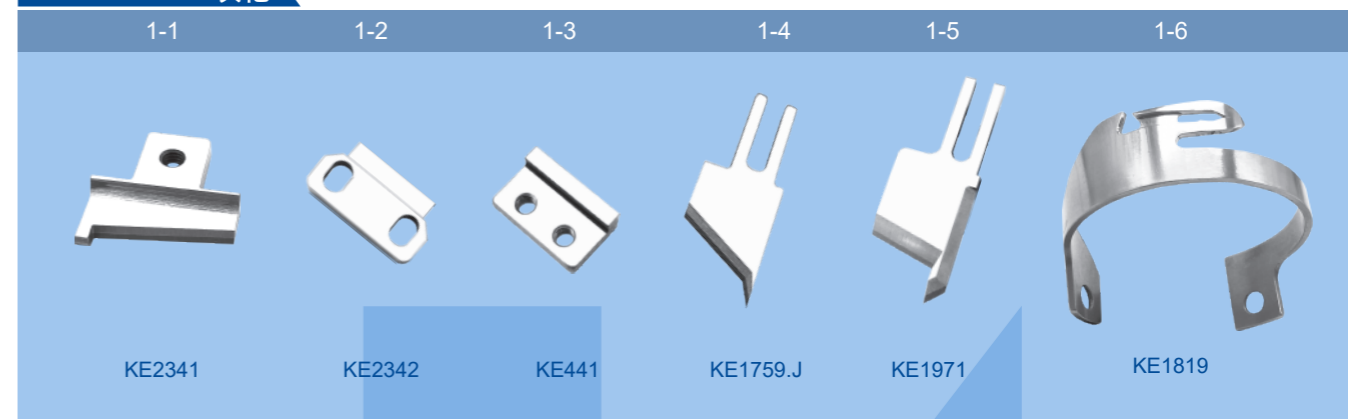

FOR OTHERS/其他

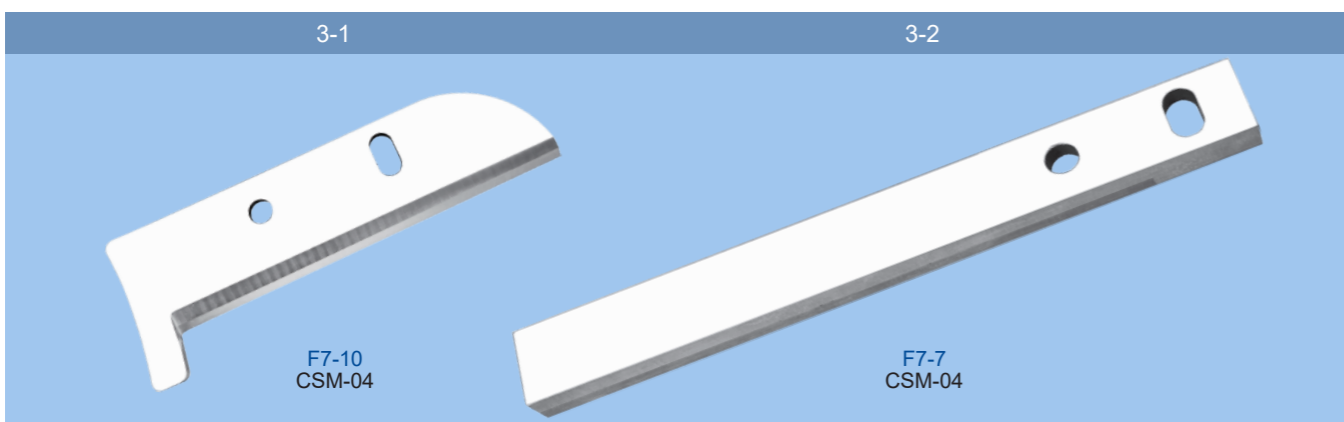
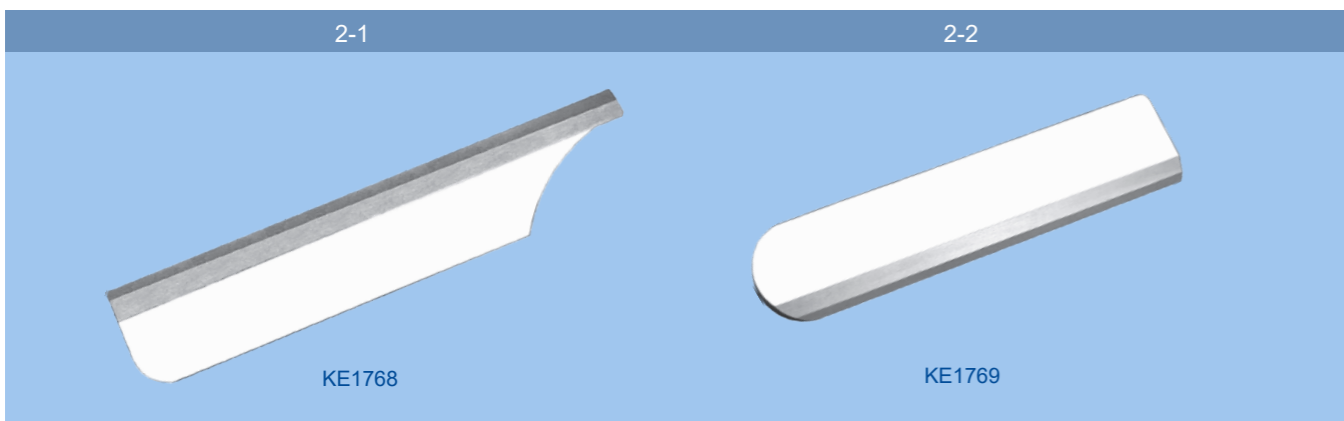
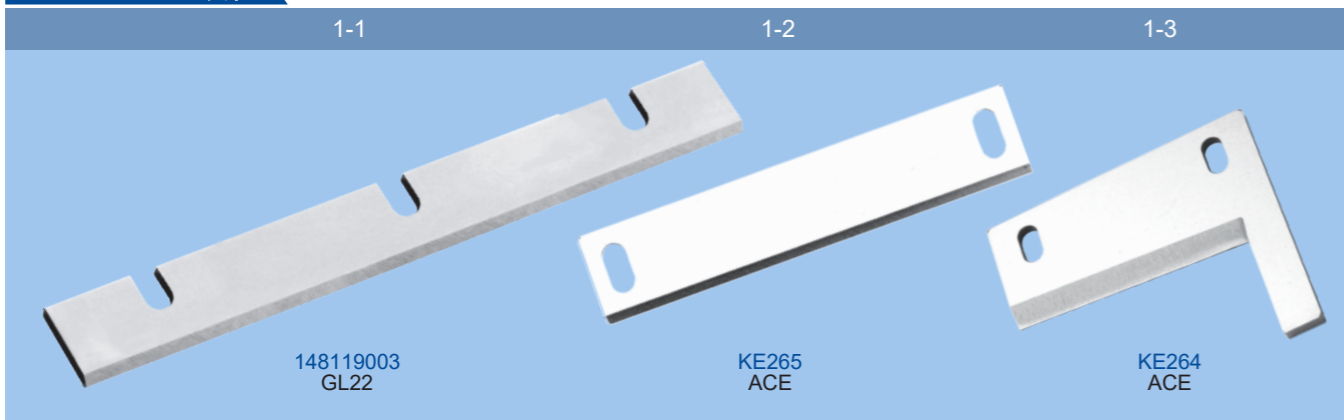

VIBRATION CUTTER/振动刀

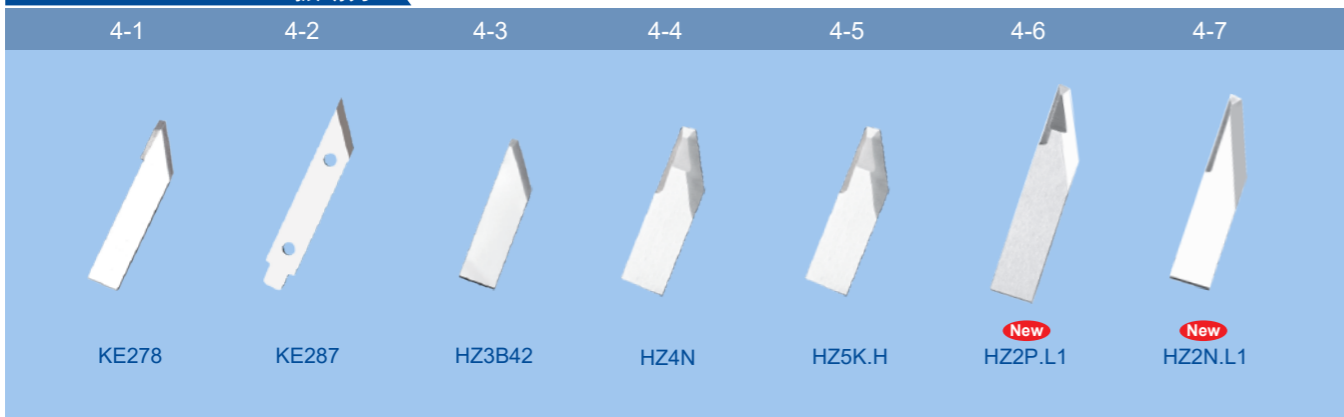

VIBRATION CUTTER/振动刀

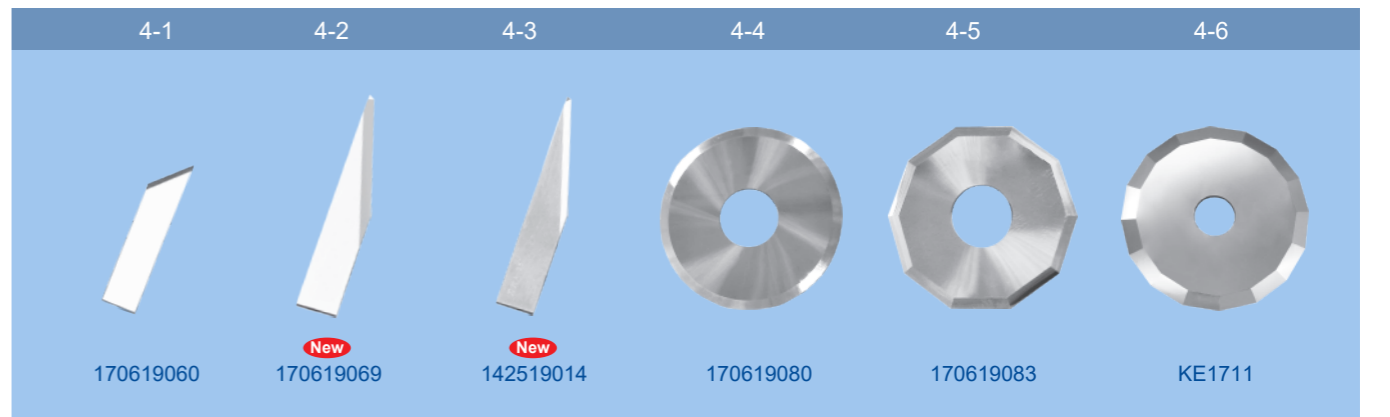
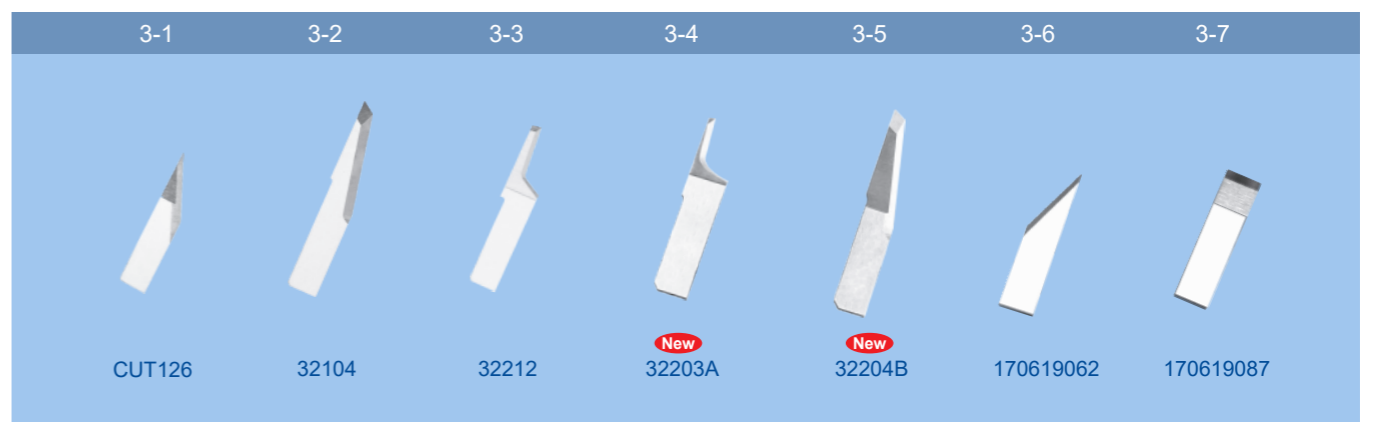
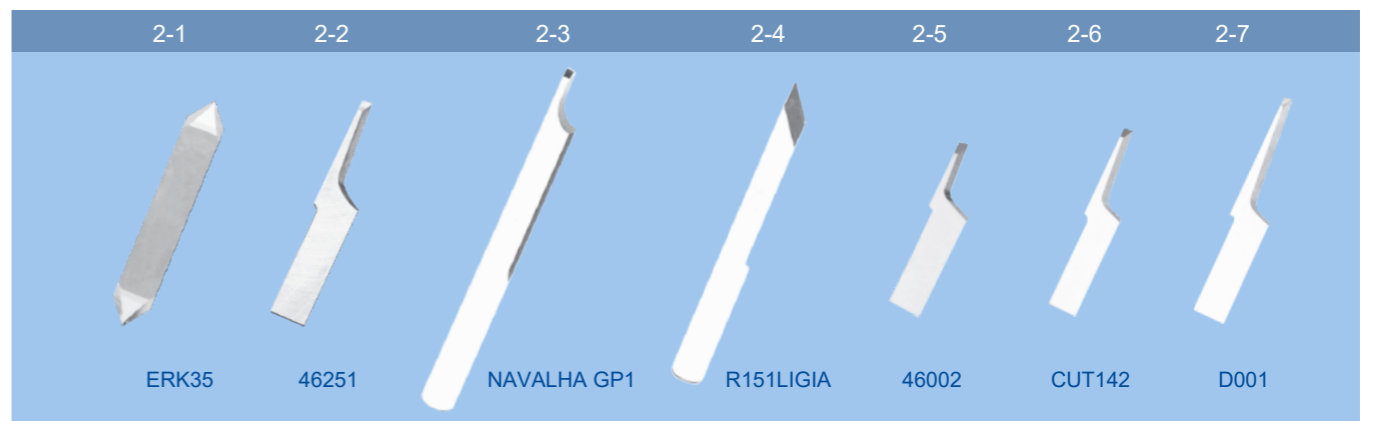
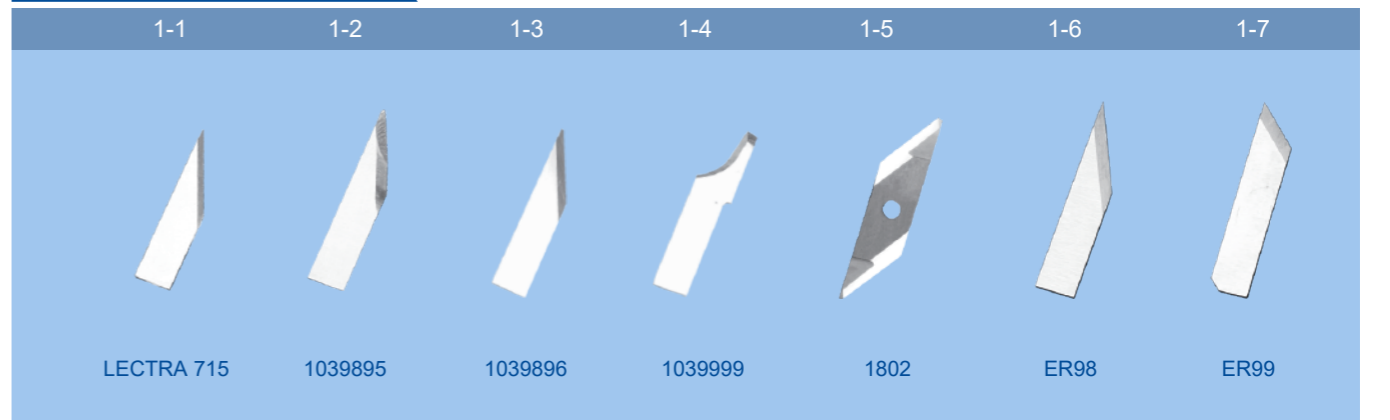

FOR BROTHER/兄弟

1-1 1-2 1-3

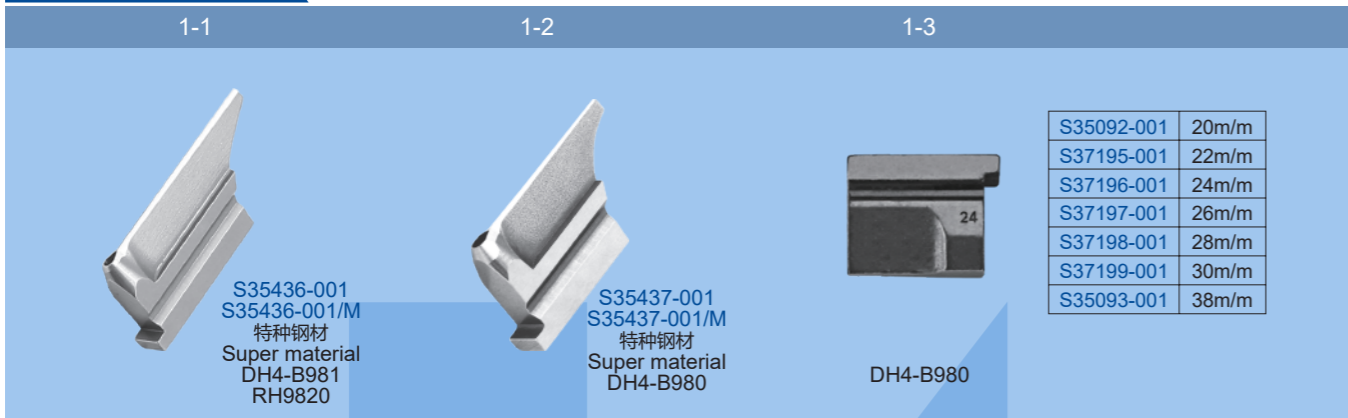

S35436-001
S35436-001/M
特种钢材
Super material
DH4-B981
RH9820

S35437-001
S35437-001/M
特种钢材
Super material
DH4-B980

DH4-B980

S35092-001	20m/m
S37195-001	22m/m
S37196-001	24m/m
S37197-001	26m/m
S37198-001	28m/m
S37199-001	30m/m
S35093-001	38m/m

2-1 2-2 2-3 2-4 2-5

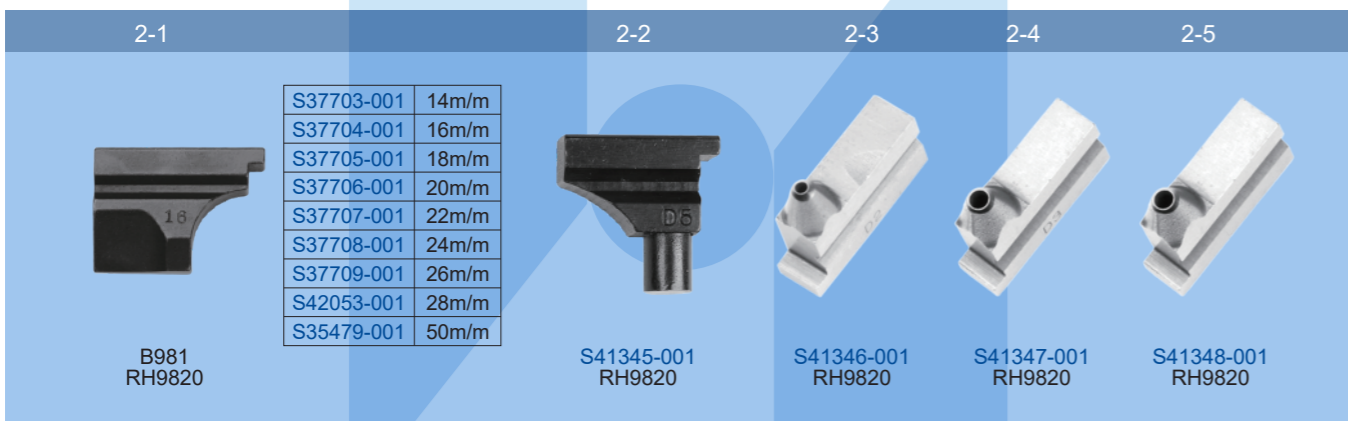

B981
RH9820

S37703-001	14m/m
S37704-001	16m/m
S37705-001	18m/m
S37706-001	20m/m
S37707-001	22m/m
S37708-001	24m/m
S37709-001	26m/m
S42053-001	28m/m
S35479-001	50m/m

S41345-001
RH9820

S41346-001
RH9820

S41347-001
RH9820

S41348-001
RH9820

FOR JUKI/重机

3-1 3-2 3-3



B980
RH9820

S37209-001	14m/m
S37208-001	16m/m
S37194-001	18m/m
S35092-001	20m/m
S37195-001	22m/m
S37196-001	24m/m
S37197-001	26m/m

S37198-001	28m/m
S37199-001	30m/m
S37200-001	32m/m
S37201-001	34m/m
S37202-001	36m/m
S35093-001	38m/m
SA7106-001	42m/m

14041206
14041206/M
特种钢材
Super material
MEB-3200

40115665
MEB-3810

4-1 4-2

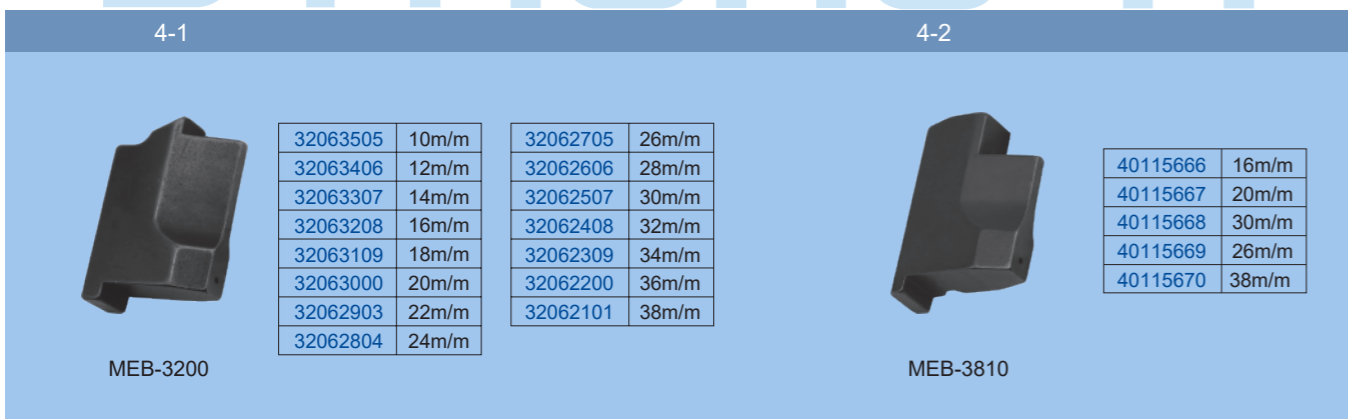

MEB-3200

32063505	10m/m
32063406	12m/m
32063307	14m/m
32063208	16m/m
32063109	18m/m
32063000	20m/m
32062903	22m/m
32062804	24m/m

32062705	26m/m
32062606	28m/m
32062507	30m/m
32062408	32m/m
32062309	34m/m
32062200	36m/m
32062101	38m/m

40115666 16m/m

40115667 20m/m

40115668 30m/m

40115669 26m/m

40115670 38m/m

MEB-3810

FOR DURKOPP/杜克普

1-1 1-2 1-3 1-4 1-5

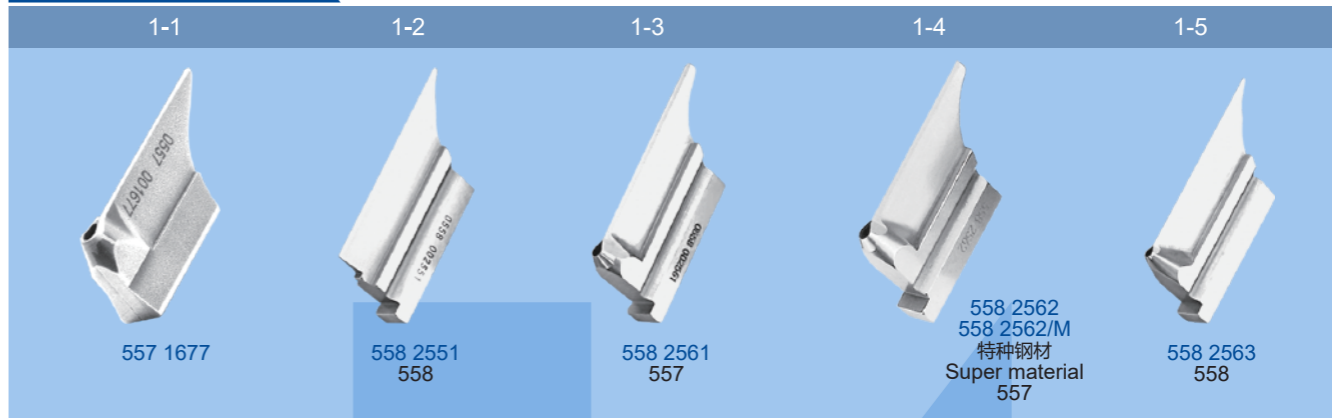

557 1677

558 2551
558

558 2561
557

558 2562
558 2562/M
特种钢材
Super material
557

558 2563
558

2-1 2-2 2-3 2-4 2-5

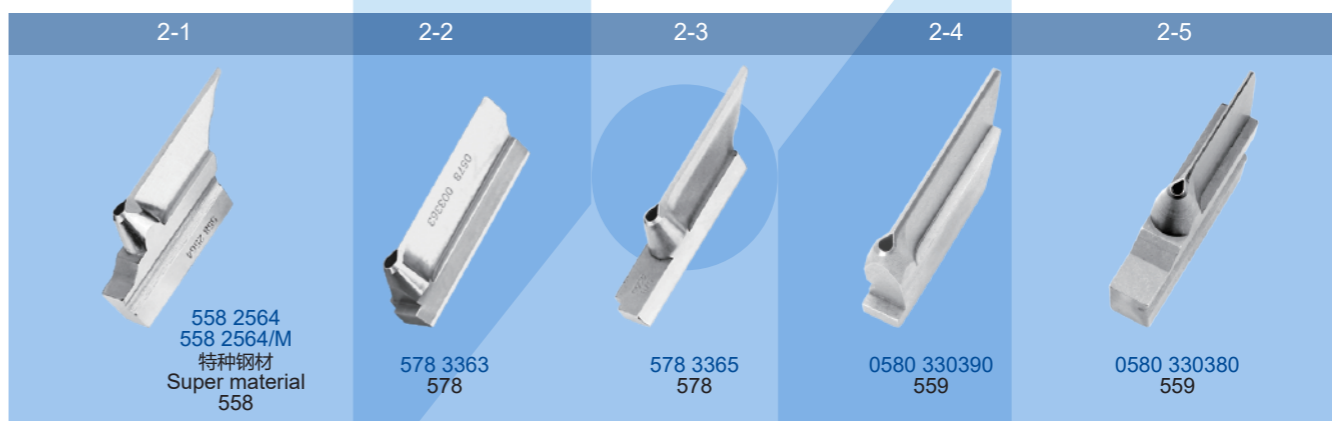

558 2564
558 2564/M
特种钢材
Super material
558

578 3363
578

578 3365
578

0580 330390
559

0580 330380
559

3-1 3-2 3-3 3-4

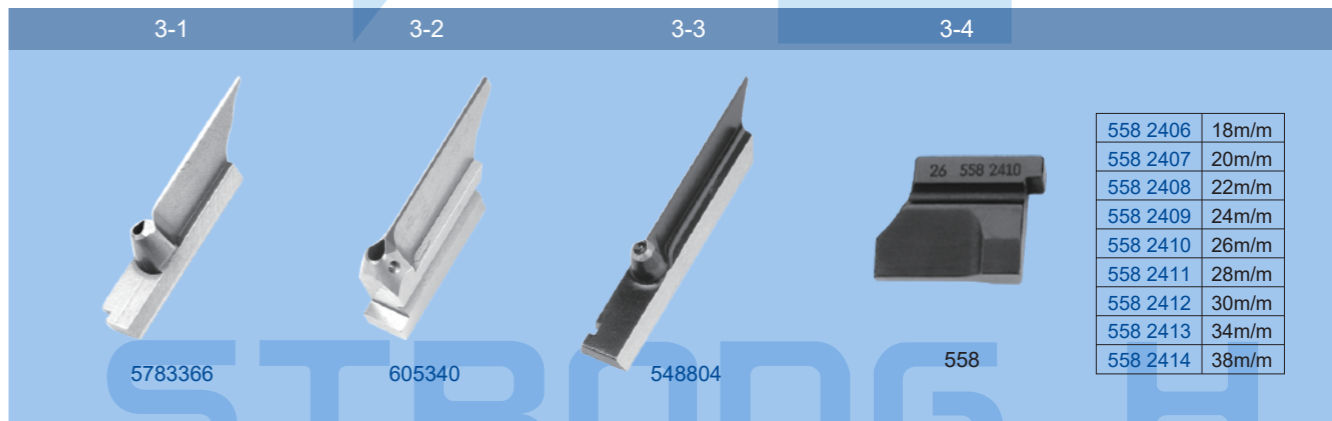

5783366

605340

548804

558

558 2406	18m/m
558 2407	20m/m
558 2408	22m/m
558 2409	24m/m
558 2410	26m/m
558 2411	28m/m
558 2412	30m/m
558 2413	34m/m
558 2414	38m/m

4-1 4-2



559

0580 330040	16m/m
0580 330050	18m/m
0580 330060	20m/m
0580 330070	22m/m
0580 330080	24m/m
0580 330090	26m/m
0580 330100	28m/m
0580 330110	30m/m
0580 330120	32m/m
0580 330130	34m/m
0580 330140	36m/m
0580 330150	38m/m

578

578 3283	14m/m
578 3284	16m/m
578 3285	18m/m
578 3286	20m/m
578 3287	22m/m
578 3288	24m/m
578 3289	26m/m
578 3290	28m/m
578 3291	30m/m
578 3292	32m/m
578 3293	34m/m
578 3294	36m/m

FOR LSM/利华

1-1 1-2



113-043-000
LSM-150



111-150-000	13m/m
111-151-000	16m/m
111-152-000	19m/m
111-153-000	22m/m
111-154-000	25m/m
111-155-000	28m/m
111-156-000	32m/m

1-3



10-3072-0-024
10-3072-0-024/M
特种钢材
Super material
101

2-1 2-2 2-3 2-4



10-3072-0-014
10-3072-0-014/M
特种钢材
Super material
101



17-0064-5-864 3/5CA
100



17-0064-5-864 3/5CB
100



17-0064-5-863

3-1 3-2



10-1069-0-051	7/8"
10-1069-0-052	1"
10-1069-0-054	1 1/4"
10-1069-0-055	1 3/8"
10-1069-0-056	1 1/2"
10-1069-0-060	2"

101



17-0064-5-951	13m/m
17-0064-5-849	16m/m
17-0064-5-852	22m/m
17-0064-5-854	26m/m
17-0064-5-855	29m/m
17-0064-5-856	32m/m
17-0064-5-858	38m/m

100

4-1 4-2



REECE10018MM
REECE10019MM
REECE10020MM
REECE10024MM
REECE10029MM
REECE10030MM
REECE10035MM

100



10-1069-0-001	1/2"
10-1069-0-002	5/8"
10-1069-0-003	3/4"
10-1069-0-004	7/8"
10-1069-0-005	1"
10-1069-0-006	1 1/8"
10-1069-0-007	1 1/4"

104

FOR SINGER/胜家

1-1 1-2



548762	1/2"
548763	5/8"
548764	3/4"
548765	7/8"
548766	1"
548767	1 1/8"
548768	1 1/4"
548769	1 3/8"
548770	1 1/2"
548771	1 5/8"

299U

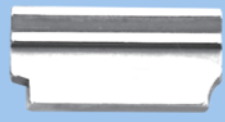

548752	1/2"
548753	5/8"
548754	3/4"
548755	7/8"
548756	1"
548757	1 1/8"
548758	1 1/4"
548759	1 3/8"
548760	1 1/2"
548761	1 5/8"

299U

FOR JACK/杰克

2-1 2-2 2-3



JK-T580-01-28-016
JK-580

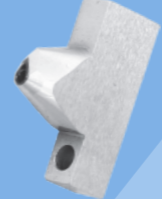

JK-T580-01-28-017
JK-580

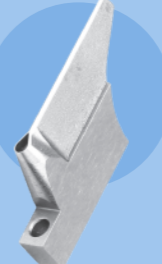

JK-T580-01-28-018
JK-580



包缝机自动剪线刀类系列
FOR OVERLOCK AUTO TRIMMER KNIVES

FOR JACK/杰克

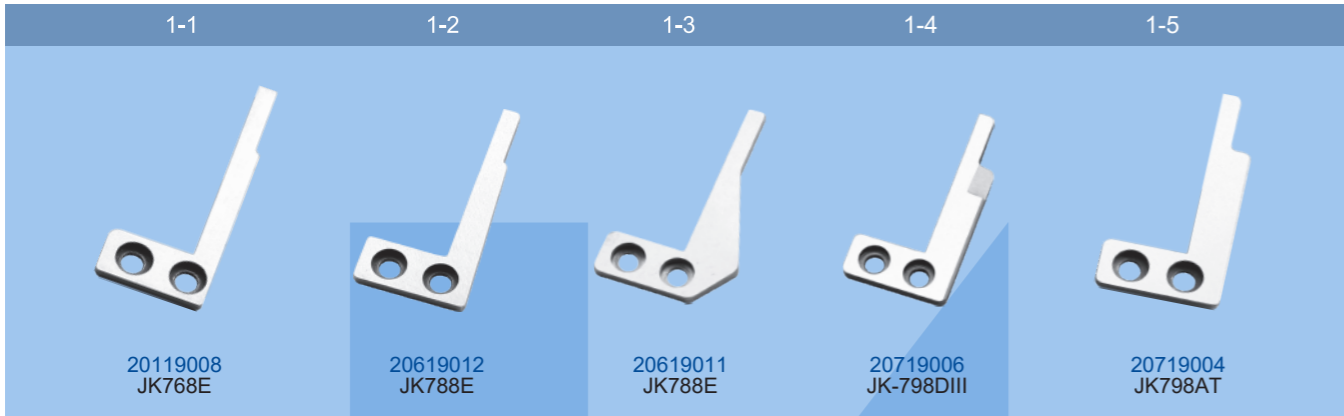

FOR JUKI/重机

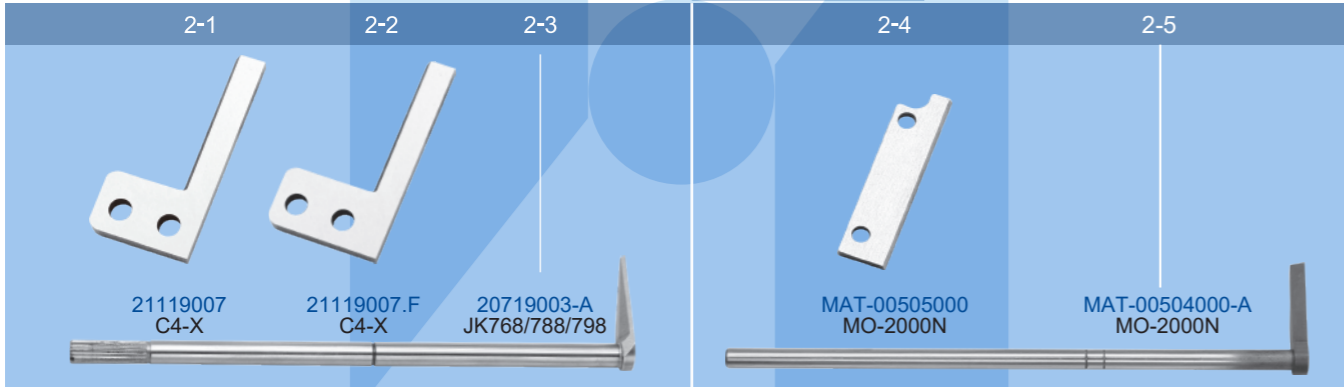

FOR HIKARI/富山

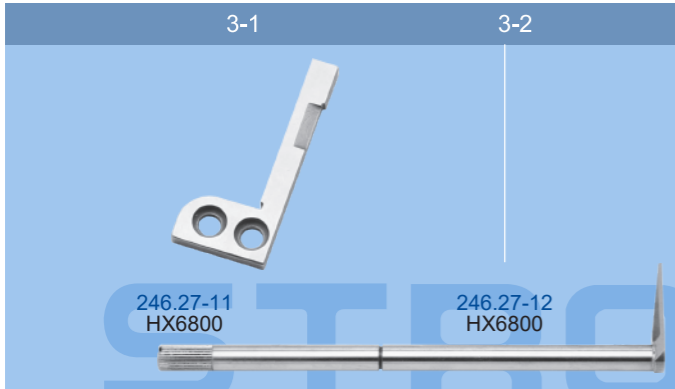

FOR SIRUBA/银箭

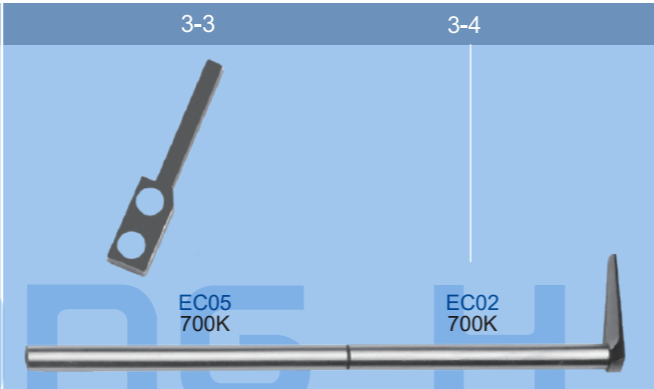

FOR PEGASUS/飞马

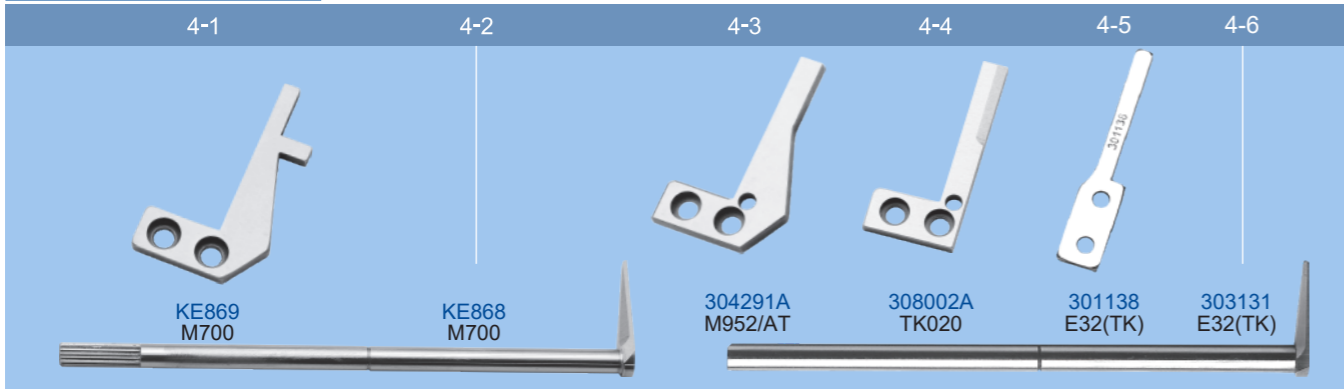

FOR ZOJE/中捷

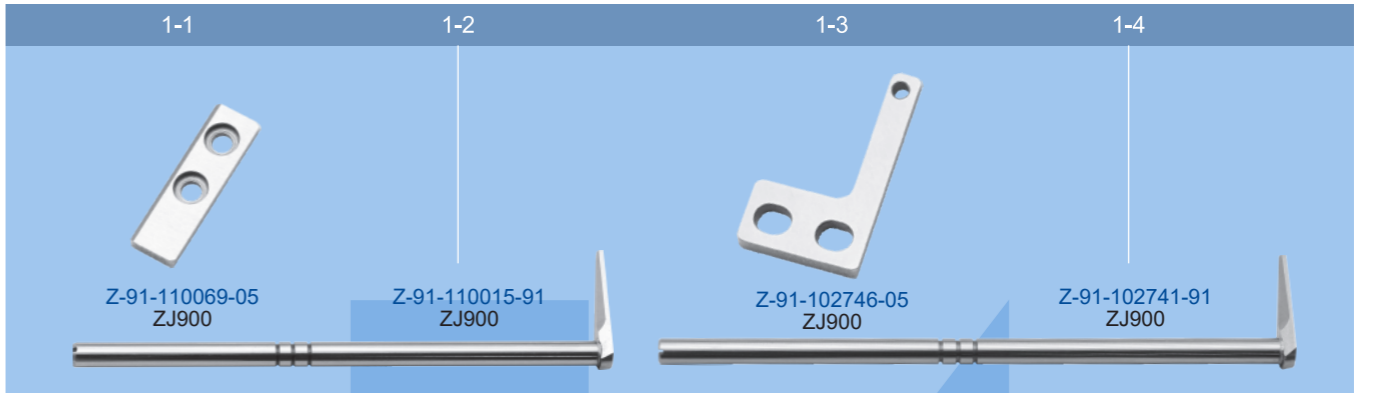

FOR OTHERS/其他

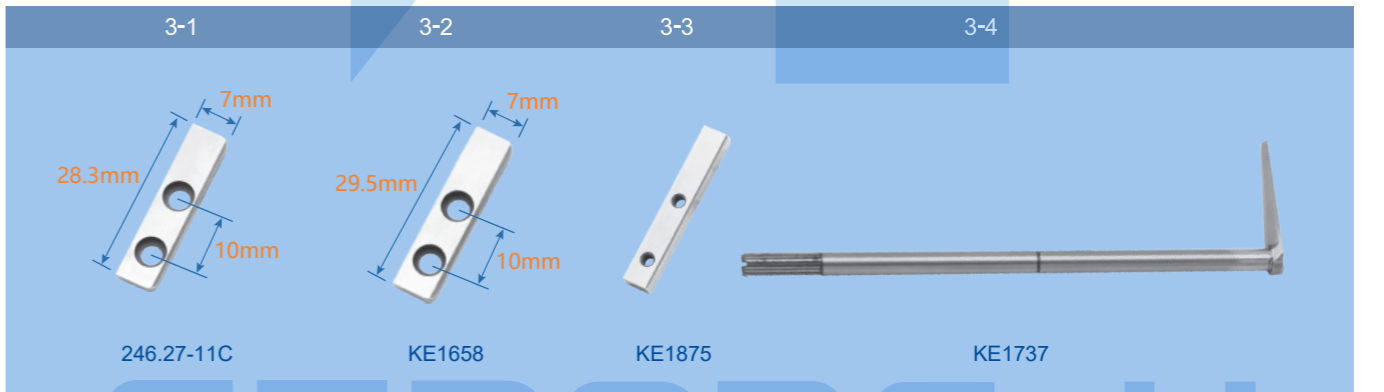
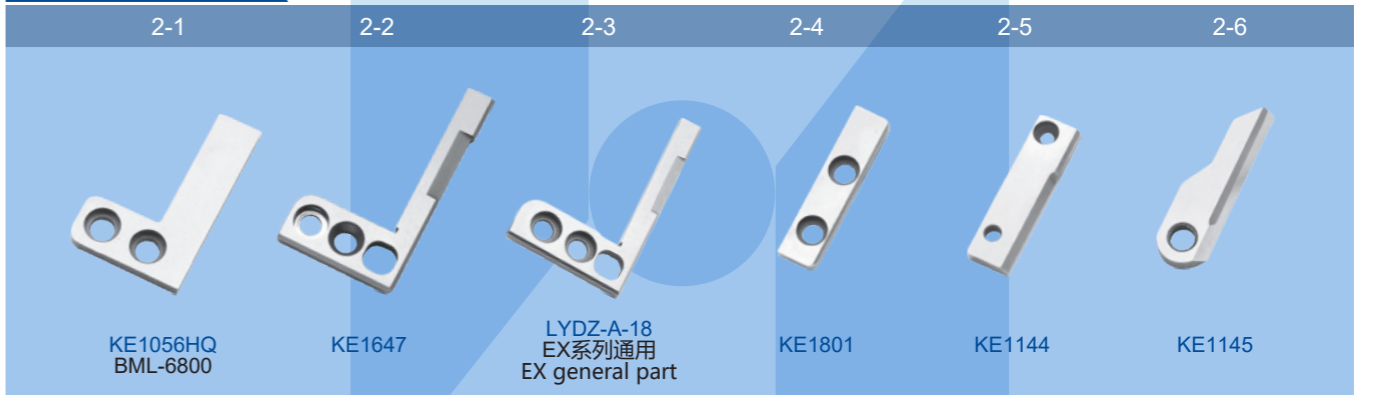

自动模板机系列
FOR AUTO PATTEN SEWING MACHINE SPARE PARTS

FOR JACK/杰克

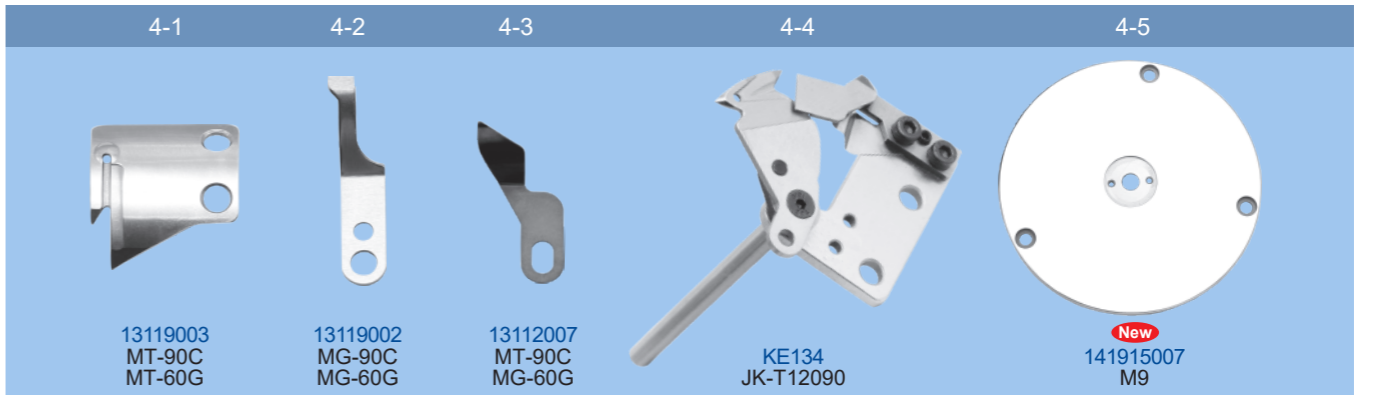



工业缝纫机刀类

KNIVES FOR INDUSTRIAL SEWING MACHINES

INDUSTRIAL SEWING MACHINES SPARE PARTS

FOR JACK/杰克

1-1	1-2	1-3	1-4	1-5
41815012(φ1.6) 41815617(φ1.8) 41815618(φ2.0) 41815614(φ2.5) 41815615(φ3.0) MT-90C MS-90A	41815011(φ1.8) JK-T12090 42215502(φ6.35) JK-T10080	141915003 P1.8 MX-100B	41815015 JK-T12090	42515001 MT-60G

2-1	2-2	2-3
41815601 MT-90C	142015001 MS-100A	141915001 MS-90A

FOR JUITA/川田

3-1	3-2	3-3	3-4	3-5
891264-UVZ	MF02A0838	MS07A0180	980478-14(φ1.4) 980478-16(φ1.6) 980478-19(φ1.9) 980478-30(φ3.0)	B91663-B

FOR MAQI/美机

4-1	4-2	4-3	4-4	4-5	4-6	4-7
PFM010803 M8-80	PF03030828 M8-80	PF03030825 M8-80	PFM90804 M8-80	PFMJ0824 M928	PFMJ0826 M928	PFM90143(φ1.4) PFM90143A(φ2.0) M928

工业缝纫机刀类

KNIVES FOR INDUSTRIAL SEWING MACHINES

INDUSTRIAL SEWING MACHINES SPARE PARTS



FOR NANBANG/南邦

1-1	1-2	1-3	1-4	1-5	1-6
Q21-004	Q21-033	Q21-036	0281 350300	0281 350310	7024029(φ1.6) 7024029-1(φ2.0)

FOR NICERBA/耐拓

2-1	2-2	2-3	2-4	2-5	2-6	2-7
0281350300 NT-8200	0281 350310 NT-8200	82000138290(φ1.4) 82000170290(φ2.4) 82000171290(φ3.0) 82000172290(φ3.5) NT-8200	Z-91-192330-05 ZJ-AM5	S02637-001 ZJ-AM5	S02643-001 ZJ-AM5	Z-91-383538-35(φ1.4) Z-91-188732-35(φ1.6) Z-91-192107-35(φ2.0) ZJ-AM5

FOR ZOJE/中捷

FOR CHNKI/中缝重工

3-1	3-2	3-3
New 0281350300/ZF 281	New 0281350310/ZF 281	New AE-12080A 281

FOR DOSO/大森

4-1	4-2	4-3	4-4
3052737021	3052707020	3052707016	3052733010(φ1.6) 3052733009(φ2.0) 3052733020(φ3.0)

We always bringing you the BEST



Knives

for cutting machines
裁剪机系列刀类

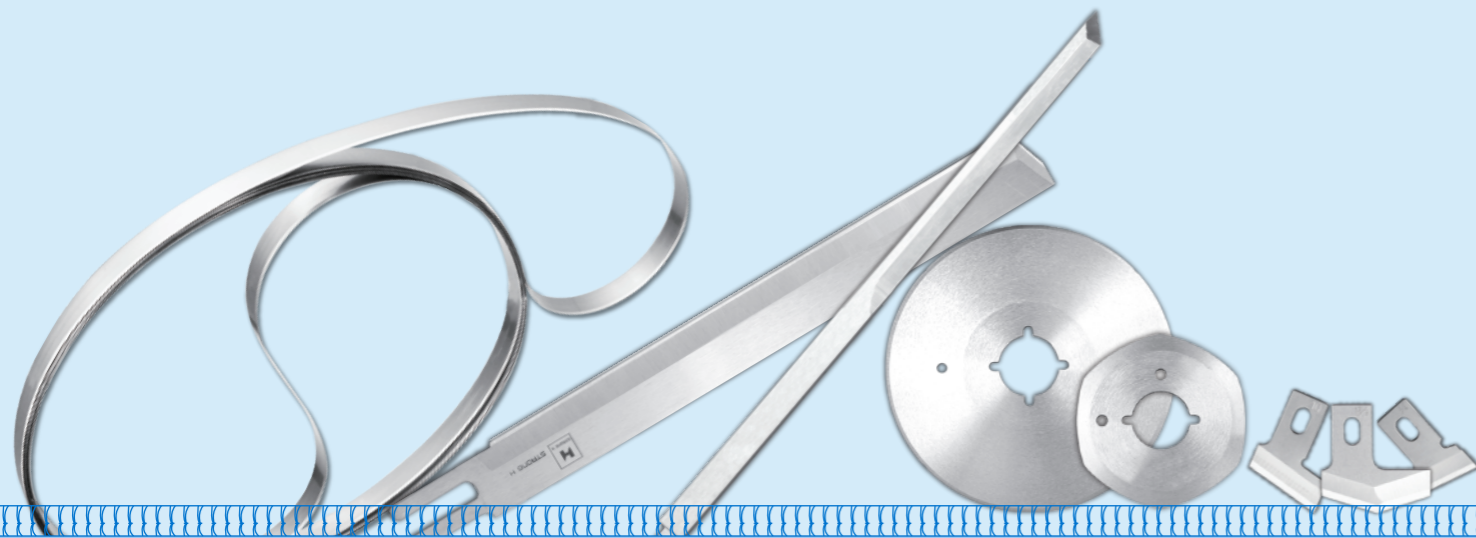

2025-2026

Industrial sewing machine spare components
工业缝纫机零配件部分



强信机械科技
STRONG H MACHINERY TECHNOLOGY

裁断机圆刀

ROUND KNIVES FOR END CUTTER MACHINES

INDUSTRIAL SEWING MACHINES SPARE PARTS



FOR EASTMAN

	1-1	1-2	1-3
SIZE	102×40×1.05	133×52×1.05	125×21×1.6
PART NO.	R4E 80C1-59 80C1-59[4A] 80C1-59[5A]	80C1-61 R5 1/4E	80C125-21 KE149(8) KE149(8)[4A] KE149(8)[5A]

FOR HITAKA

	2-1
SIZE	90×17.5×1.1
PART NO.	R31/2H R31/2H[4A] R31/2H[5A]

FOR HOOGS

	2-2	2-3
SIZE	50×10×1.2	110×10×1.6
PART NO.	KE2635	H00G'S110(4) H00G'S110(4)[4A]



FOR KM

	2-4
SIZE	50×10×1.2
PART NO.	RS-50 R2KM A-113(R)

	3-1	3-2	3-3	3-4
SIZE	50×10×1.2	50×10×1.2	127×43×1.2	152×50×1.5
PART NO.	RS-50(6) R2KM(6) A-113(6)	R2KM(7) RS-50(7) RS-50(7)[4A]	R5KM R5KM[4A] R5KM[5A]	R6KM R6KM[4A] R6KM[5A]

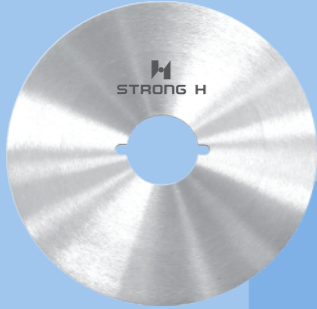
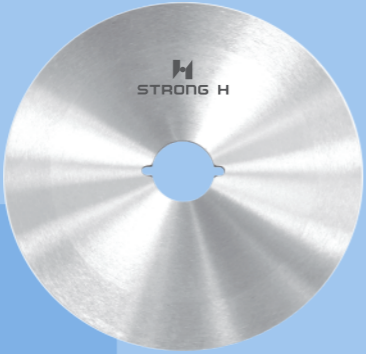

FOR HOFFMANHF

FOR JACK

	1-1	1-2	1-3
			
SIZE	95.5×22.1×1.1	125.5×22.1×1.2	110×10×1.2
PART NO.	HF100[5A]	HF125[5A]	KE537[4A] 84619001 KW2000

FOR KURIS

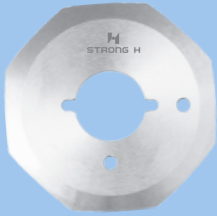
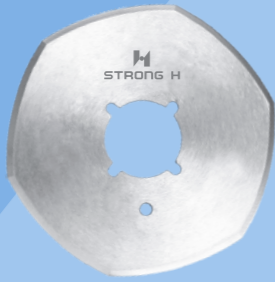
FOR SUPRENA

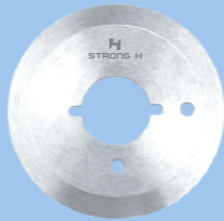

	2-1	2-2	2-3	2-4
				
SIZE	50×16×1.0	80×22×1	100×22×1.0	50×16×1
PART NO.	KE725(8)[5A]	R16092(6) R16092(6)[4A]/[5A] 46377/B0M-80	B0M-101(4) B0M-101(4)[4A]	M0702[4A]

FOR SUPRENA

	3-1	3-2	3-3	3-4
				
SIZE	50×16×1	50×16×1	100×22×1	100×22×1
PART NO.	M0700(6)[4A]	M0703(8)[4A]	R1512 R1512[4A]	R1513(6) R1513(6)[4A]

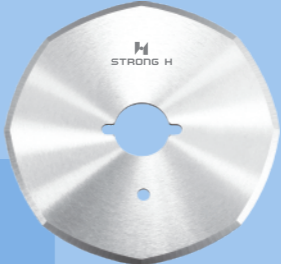
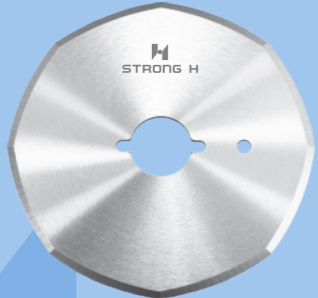
GENERAL ROUND CORNER KNIFE/通用型圆角刀

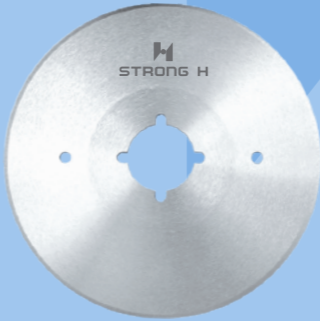
	1-1	1-2	1-3
			
SIZE	65×10×1	70×16.5×1	90×18×1.2
PART NO.	KE873(6) KE873(6)[4A] KE873(6)[5A]	KE874(8) KE874(8)[4A] KE874(8)[5A]	KE875(8) KE875(8)[4A] KE875(8)[5A]

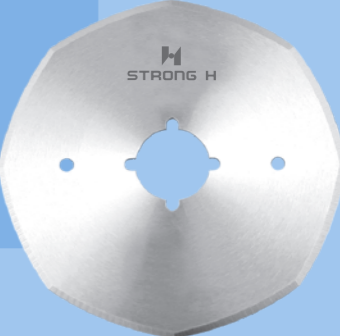
	2-1	2-2	2-3
			
SIZE	100×21×1.2	100×21×1.2	110×21×1.3
PART NO.	RS-100 RS-100[4A] RS-100[5A]	RS-100(8) RS-100(8)[4A] RS-100(8)[5A]	RS-110(8) RS-110(8)[4A] RS-110(8)[5A]

SPLITTING KNIFE/剖缝机刀

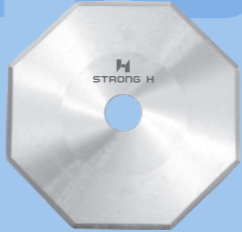
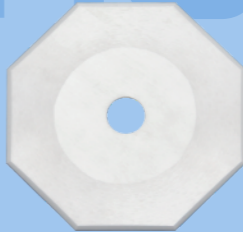
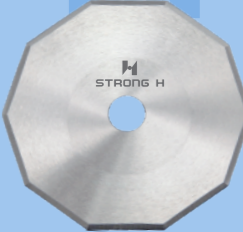
	3-1	3-2	3-3	3-4
				
SIZE	65×10.9×0.65	68×10×0.5	68×10×0.5	68×10×0.5
PART NO.	KE915(6) KE915(6)[5A]	KE1045(8) KE1045(8)[4A] KE1045(8)[5A]	KE1045(8)[TC] 陶瓷材质 Ceramic material	KE1045(10) KE1045(10)[5A]



裁断机圆刀

ROUND KNIVES FOR END CUTTER MACHINES

INDUSTRIAL SEWING MACHINES SPARE PARTS

SPLITTING KNIFE/剖缝机刀

1-1

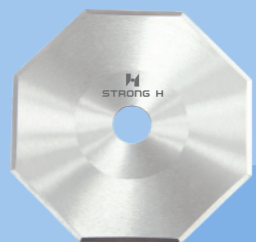

SIZE 68×10×0.6
PART NO. KE919(8)
KE919(8)[5A]

1-2

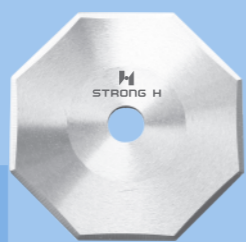

SIZE 68×10×1
PART NO. KE920(8)
KE920(8)[5A]

1-3

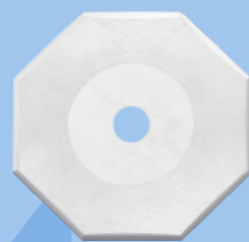

SIZE 68×10×1
PART NO. KE920(8)[TC]
陶瓷材质
Ceramic material

MANUAL DRIVE ROTARY CUTTER/手动轮刀

2-1



SIZE 28.5×5×0.3
PART NO. KE301[4A]

2-2



SIZE 45×8×0.3
PART NO. KE918[4A]

2-3



SIZE 60×10×0.3
PART NO. KE1033[4A]

FOR OTHERS/其他

2-4



SIZE 28×5×0.3
PART NO. BT113072(10)[4A]

FOR OTHERS/其他

3-1



SIZE 42×5.5×1
PART NO. KE492(10)
KE492(10)[5A]

3-2

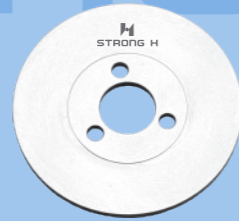

SIZE 48.2×12×2
PART NO. KE1171
KE1171[5A]

3-3



New
SIZE 48.2×12×2
PART NO. KE2695

3-4



SIZE 50×10×1.8
PART NO. KE817(7)

裁断机圆刀

ROUND KNIVES FOR END CUTTER MACHINES

INDUSTRIAL SEWING MACHINES SPARE PARTS



FOR OTHERS/其他

1-1



SIZE 49×13×1.1
PART NO. KE600(6)
KE600(6)[4A]

1-2

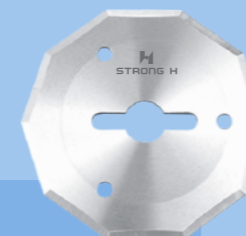

SIZE 59.5×10×1.4
PART NO. KE601(10)
KE601(10)[4A]
KE601(10)[5A]

1-3



SIZE 60×10×1.4
PART NO. KE601

1-4

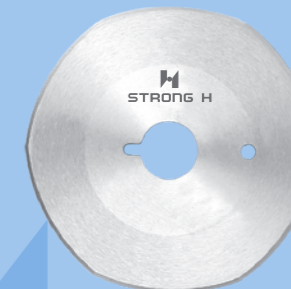

SIZE 89×17.5×1.1
PART NO. KE610(6)
KE610(6)[4A]

2-1



SIZE 60×12×0.8
PART NO. MK-5D[4A]

2-2

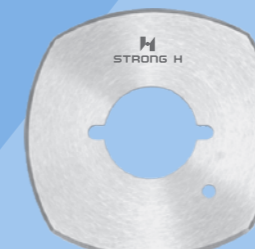

SIZE 67×22.2×1
PART NO. SF833(4)[4A]
SF833(4)[5A]

2-3

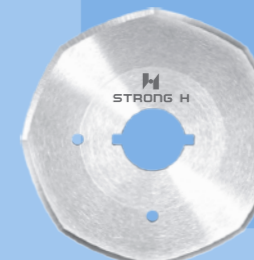

SIZE 70×16.58×1.2
PART NO. KE172(8)
KE172(8)[4A]
KE172(8)[5A]

2-4



SIZE 89×17.5×1.2
PART NO. KE688

FOR OTHERS/其他

3-1



SIZE 70×40×1
PART NO. TK17(1Convexity)
TK17(1Convexity)[4A]

3-2

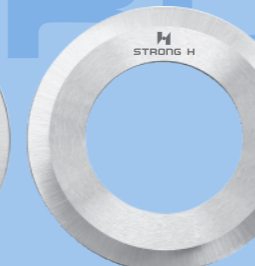

SIZE 70×40×1
PART NO. TK17(2Convexity)
TK17(2Convexity)[4A]

3-3



SIZE 80×40×1
PART NO. TK18
TK18[4A]
TK18[5A]

3-4



SIZE 90×15.2×1
PART NO. MK-90H[4A]



裁断机圆刀

ROUND KNIVES FOR END CUTTER MACHINES

INDUSTRIAL SEWING MACHINES SPARE PARTS

FOR OTHERS/其他

1-1

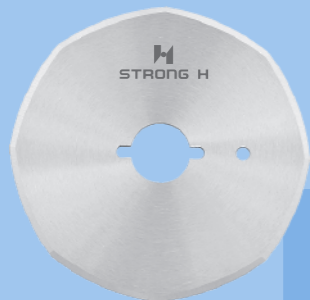

SIZE
PART NO. 90×18×1.3
KE268(8)[4A]

1-2



100×25.4×1.4
KE242
KE242[4A]

1-3



102×40×1.25
KE678

2-1



SIZE
PART NO. 108×10×1.25
2631-T
2631-T[4A]
2631-T[5A]
R4 1/4

2-2

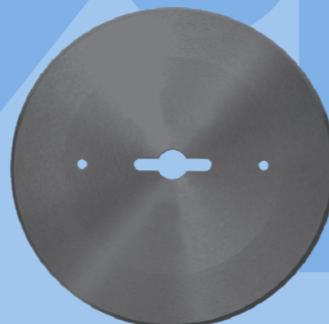

108×10×1.25
2631-T(TFL)
R4 1/4(TFL)

2-3

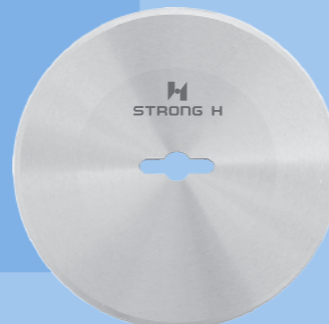

109×10×1.25
KE272
KE272[4A]

3-1



SIZE
PART NO. 110×10×1.2
KE537[4A]

3-2

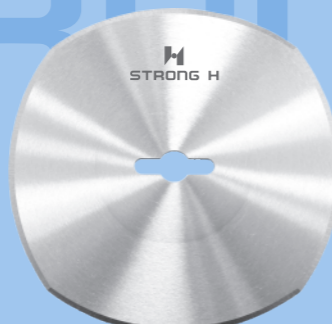

110×10×1.1
KE841(4)[4A]

3-3



110×10.2×1.3
KE273(8)
KE273(8)[4A]

裁断机圆刀

ROUND KNIVES FOR END CUTTER MACHINES

INDUSTRIAL SEWING MACHINES SPARE PARTS



FOR OTHERS/其他

1-1

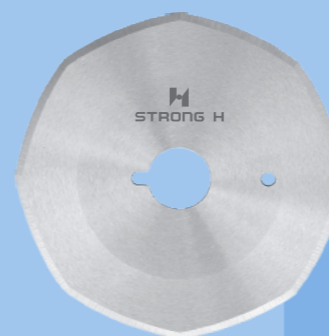

SIZE
PART NO. 110×21×1.4
KE148(8)

1-2



110×21×1.5
KE291(8)
KE291(8)[4A]

1-3



124×10.8×0.85
KE916(6)
KE916(6)[5A]

2-1



SIZE
PART NO. 127×40×1.05
KA-5

2-2

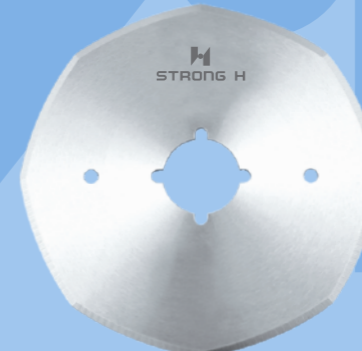

125×21×1.2
KE1049(8)
KE1049(8)[4A]
KE1049(8)[5A]

2-3

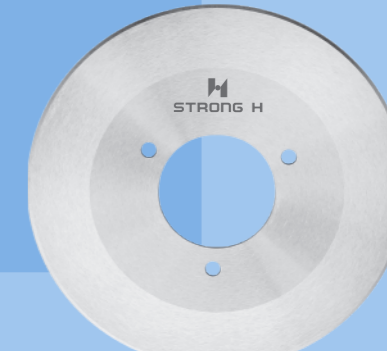

130×40.18×1.2
130
130[4A]

LOWER KNIFE/底刀

3-1



SIZE
PART NO. 156×14×1.8
KE450

3-2 3-3 3-4

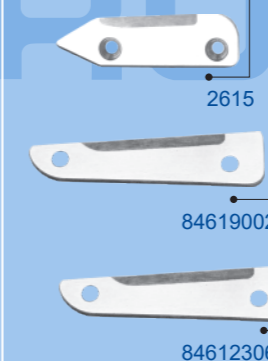

2615

84619002

84612306

3-5 3-6 3-7 3-8

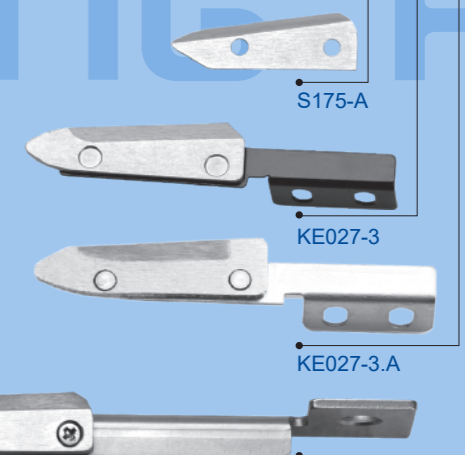

S175-A

KE027-3

KE027-3.A

261416



分条机刀

METAL CIRCULAR KNIFE FOR RIBBON CUTTING MACHINE

INDUSTRIAL SEWING MACHINES SPARE PARTS

METAL CIRCULAR KNIFE FOR RIBBON CUTTING MACHINE/分条机刀

1-1



STRONG H

PART NO./品号	SIZE/规格	MATERIAL/材质
KE593	300×38.1×2.5	Alloy Steel/合金钢、Super Alloy Steel/特殊合金钢
KE594	300×38.1×2.8	Alloy Steel/合金钢 Super Alloy Steel/特殊合金钢
KE1116	350×25×2.8	Alloy Steel/合金钢 Super Alloy Steel/特殊合金钢
KE947	350×38.1×2.8	Alloy Steel/合金钢 Super Alloy Steel/特殊合金钢
KE1824	400×37×3	Alloy Steel/合金钢 Super Alloy Steel/特殊合金钢
KE1117	400×38.1×3	Alloy Steel/合金钢 Super Alloy Steel/特殊合金钢
.....

削皮刀

SKIVING KNIFE FOR END CUTTER MACHINES

INDUSTRIAL SEWING MACHINES SPARE PARTS



SKIVING KNIFE/削皮刀

1-1



SIZE
PART NO.

301A

STRONG H



滚条机刀

CLOTH SLITTING KNIVES

INDUSTRIAL SEWING MACHINES SPARE PARTS

CLOTH SLITTING KNIVES/滚条机刀

1-1

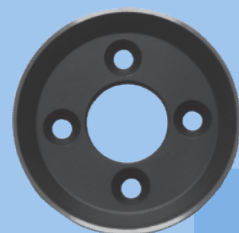

SIZE
PART NO. 62×22×8.5
801-1

1-2



SIZE
PART NO. 62×22×8.5
801-2

1-3

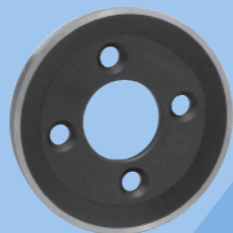

SIZE
PART NO. 62×22×8.5
802-1

1-4

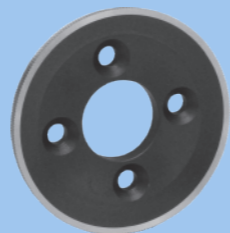

SIZE
PART NO. 62×22×7.5
802-2

2-1

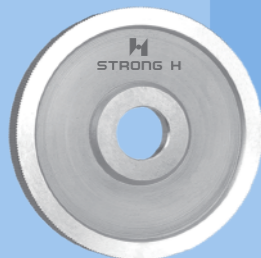

SIZE
PART NO. 72×15×4.5
72×16×4.3
901-1

2-2



SIZE
PART NO. 72×15×4.5
72×16×4.3
901-2

2-3



SIZE
PART NO. 71.6×15×4.5
B1-1
911-1/933-1

2-4



SIZE
PART NO. 71.6×15×4.5
B1-2
911-2/933-2

3-1



SIZE
PART NO. 73×14×4.4
TC-38-1

3-2



SIZE
PART NO. 73×14×4.4
TC-38-2

3-3



SIZE
PART NO. 67×16×4.0
KNIT-1

3-4



SIZE
PART NO. 67×19×4.0
KNIT-2

CAD裁刀

CAD CUTTING KNIVES

INDUSTRIAL SEWING MACHINES SPARE PARTS



FOR BULLMER/艾斯特-奔马

1-1



SIZE
PART NO. 95×6×2
BM148

1-2



SIZE
PART NO. 223×10×2.5
BM986

1-3



SIZE
PART NO. 223×10(6)×2.5(2)
BM065-S

1-4

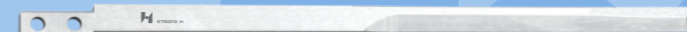

SIZE
PART NO. 223×10(8)×2.5
BM935

1-5



SIZE
PART NO. **New**
223×8×2.5
BM935.G2

1-6



SIZE
PART NO. 223×10(8)×2.5(3)
BM935.H

FOR INVESTRONICA/艾维斯

1-7



SIZE
PART NO. 187×8×1.93
CV-40

1-8



SIZE
PART NO. 252×8.3×2.5
S70817-001

1-9









SIZE
PART NO. 252×9.4×2.75
ISP05037

1-10

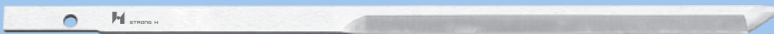



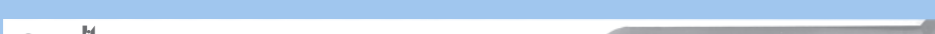



SIZE
PART NO. 296×9.4×2.75
SC-2



FOR FKARNA

1-1	
SIZE PART NO.	245×8.3×2.5 KE585
1-2	
SIZE PART NO.	245×8.3×2.5 KE497
1-3	
SIZE PART NO.	291×8×2.45 KE535
1-4	
SIZE PART NO.	291.5×8.2×2.5 KE767
1-5	
SIZE PART NO.	292×8.0×2.5 25492
1-6	
SIZE PART NO.	327×7×2 N11.0004S125
1-7	
SIZE PART NO.	370×8.5×2.4 N09.0002S101

FOR KURIS

1-1	
SIZE PART NO.	176×9.5×1.2 73436
1-2	
SIZE PART NO.	New 176×9.5×1.2 47892
1-3	
SIZE PART NO.	178×10×2.5 24306
1-4	
SIZE PART NO.	227×9.5×2 66878
1-5	
SIZE PART NO.	227×10.5×3 47968
1-6	
SIZE PART NO.	233×10.5×3 68539

FOR SHIMA SEIKI/岛精

1-7	
SIZE PART NO.	173×8.0×2.5 KE263
1-8	
SIZE PART NO.	195×7.9×1.96 KE266
1-9	
SIZE PART NO.	212×8.0×2.3 KE293



STRONG H

FOR SINGER/胜家



FOR JACK/杰克





裁剪机直刀

STRAIGHT KNIVES FOR CUTTING MACHINES

INDUSTRIAL SEWING MACHINES SPARE PARTS

FOR EASTMAN STRAIGHT KNIVES

1-1



PART NO./品号	MATERIAL/材质
5E	Alloy Steel/合金钢, Super Alloy Steel/特殊合金钢, HSS/高速钢
6E	Alloy Steel/合金钢, Super Alloy Steel/特殊合金钢, HSS/高速钢
7E	Alloy Steel/合金钢, Super Alloy Steel/特殊合金钢, HSS/高速钢
8E	Alloy Steel/合金钢, Super Alloy Steel/特殊合金钢, HSS/高速钢
9E	Alloy Steel/合金钢, Super Alloy Steel/特殊合金钢, HSS/高速钢
10E	Alloy Steel/合金钢, Super Alloy Steel/特殊合金钢, HSS/高速钢
11 1/2E	Alloy Steel/合金钢, Super Alloy Steel/特殊合金钢, HSS/高速钢
12E	Alloy Steel/合金钢, Super Alloy Steel/特殊合金钢, HSS/高速钢
13E	Alloy Steel/合金钢, Super Alloy Steel/特殊合金钢, HSS/高速钢
15E	Alloy Steel/合金钢, Super Alloy Steel/特殊合金钢, HSS/高速钢

FOR KM STRAIGHT KNIVES

2-1

窄刀 (Narrow)



PART NO./品号	MATERIAL/材质
5KM(N)	Alloy Steel/合金钢, Super Alloy Steel/特殊合金钢, HSS/高速钢
6KM(N)	Alloy Steel/合金钢, Super Alloy Steel/特殊合金钢, HSS/高速钢



PART NO./品号	MATERIAL/材质
5KM	Alloy Steel/合金钢, Super Alloy Steel/特殊合金钢, HSS/高速钢
6KM	Alloy Steel/合金钢, Super Alloy Steel/特殊合金钢, HSS/高速钢
7KM	Alloy Steel/合金钢, Super Alloy Steel/特殊合金钢, HSS/高速钢
8KM	Alloy Steel/合金钢, Super Alloy Steel/特殊合金钢, HSS/高速钢
9KM	Alloy Steel/合金钢, Super Alloy Steel/特殊合金钢, HSS/高速钢
10KM	Alloy Steel/合金钢, Super Alloy Steel/特殊合金钢, HSS/高速钢
11 1/2KM	Alloy Steel/合金钢, Super Alloy Steel/特殊合金钢, HSS/高速钢
12KM	Alloy Steel/合金钢, Super Alloy Steel/特殊合金钢, HSS/高速钢
13KM	Alloy Steel/合金钢, Super Alloy Steel/特殊合金钢, HSS/高速钢
15KM	Alloy Steel/合金钢, Super Alloy Steel/特殊合金钢, HSS/高速钢

FOR TEFLON STRAIGHT KNIVES

3-1



PART NO./品号	MATERIAL/材质
8E(TFL)	Super Alloy Steel/特殊合金钢, HSS/高速钢
10E(TFL)	Super Alloy Steel/特殊合金钢, HSS/高速钢
12E(TFL)	Super Alloy Steel/特殊合金钢, HSS/高速钢

裁剪机波刀

WAVE KNIVES FOR CUTTING MACHINES

INDUSTRIAL SEWING MACHINES SPARE PARTS



FOR EASTMAN WAVE KNIVES

1-1



PART NO./品号	MATERIAL/材质
5EW	Alloy Steel/合金钢, Super Alloy Steel/特殊合金钢, HSS/高速钢
6EW	Alloy Steel/合金钢, Super Alloy Steel/特殊合金钢, HSS/高速钢
7EW	Alloy Steel/合金钢, Super Alloy Steel/特殊合金钢, HSS/高速钢
8EW	Alloy Steel/合金钢, Super Alloy Steel/特殊合金钢, HSS/高速钢
9EW	Alloy Steel/合金钢, Super Alloy Steel/特殊合金钢, HSS/高速钢
10EW	Alloy Steel/合金钢, Super Alloy Steel/特殊合金钢, HSS/高速钢
12EW	Alloy Steel/合金钢, Super Alloy Steel/特殊合金钢, HSS/高速钢
13EW	Alloy Steel/合金钢, Super Alloy Steel/特殊合金钢, HSS/高速钢



深波浪
DEEP WAVE

PART NO./品号	MATERIAL/材质
6EW(KO)	Alloy Steel/合金钢, Super Alloy Steel/特殊合金钢, HSS/高速钢
7EW(KO)	Alloy Steel/合金钢, Super Alloy Steel/特殊合金钢, HSS/高速钢
8EW(KO)	Alloy Steel/合金钢, Super Alloy Steel/特殊合金钢, HSS/高速钢
9EW(KO)	Alloy Steel/合金钢, Super Alloy Steel/特殊合金钢, HSS/高速钢
10EW(KO)	Alloy Steel/合金钢, Super Alloy Steel/特殊合金钢, HSS/高速钢
12EW(KO)	Alloy Steel/合金钢, Super Alloy Steel/特殊合金钢, HSS/高速钢

FOR KM WAVE KNIVES

2-1

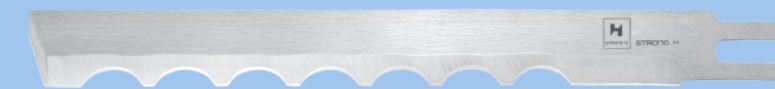

PART NO./品号	MATERIAL/材质
6KMW(N)	Alloy Steel/合金钢, Super Alloy Steel/特殊合金钢, HSS/高速钢
7KMW(N)	Alloy Steel/合金钢, Super Alloy Steel/特殊合金钢, HSS/高速钢



PART NO./品号	MATERIAL/材质
6KMW	Alloy Steel/合金钢, Super Alloy Steel/特殊合金钢, HSS/高速钢
7KMW	Alloy Steel/合金钢, Super Alloy Steel/特殊合金钢, HSS/高速钢
8KMW	Alloy Steel/合金钢, Super Alloy Steel/特殊合金钢, HSS/高速钢
9KMW	Alloy Steel/合金钢, Super Alloy Steel/特殊合金钢, HSS/高速钢
10KMW	Alloy Steel/合金钢, Super Alloy Steel/特殊合金钢, HSS/高速钢

1-1

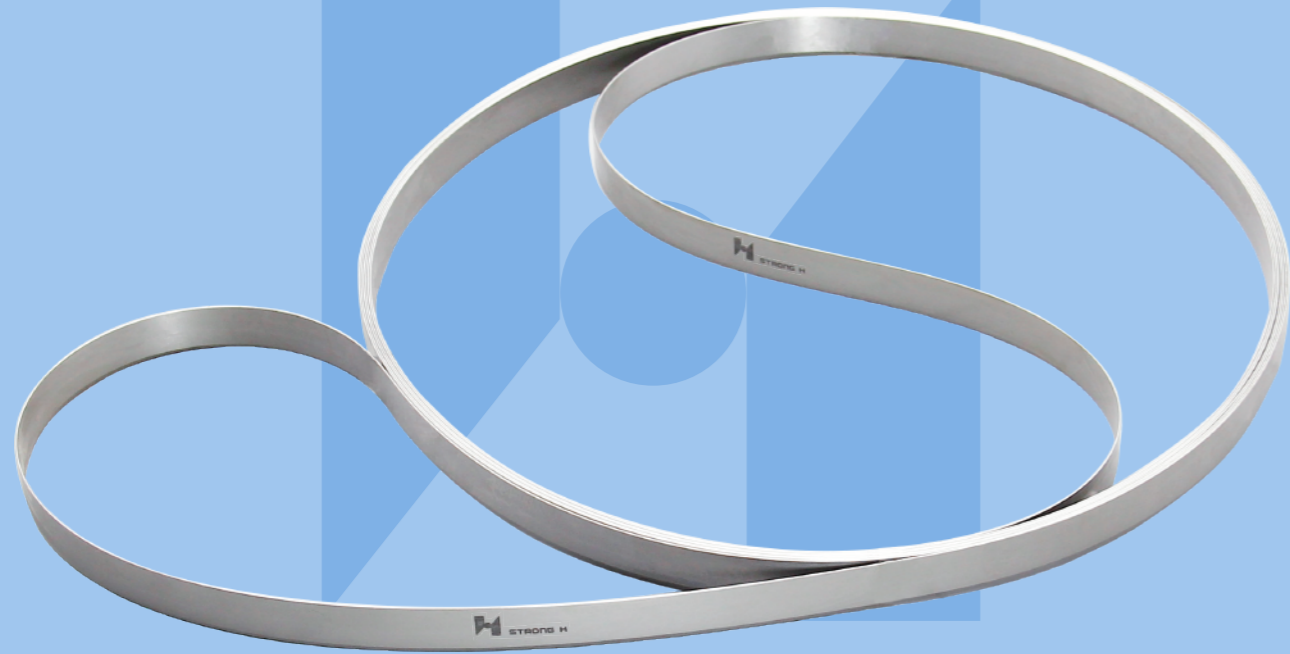

SIZE	SIZE	SIZE	SIZE	SIZE
2000×10×0.45	3250×10×0.45	4060×10×0.45	4435×10×0.45	5030×10×0.45
2450×10×0.45	3400×10×0.45	4078×10×0.45	4450×10×0.45	5040×10×0.45
2500×10×0.45	3500×10×0.45	4100×10×0.45	4460×10×0.45	5050×10×0.45
2600×10×0.45	3600×10×0.45	4120×10×0.45	4500×10×0.45	5200×10×0.45
2800×10×0.45	3700×10×0.45	4130×10×0.45	4530×10×0.45	5250×10×0.45
2830×10×0.45	3750×10×0.45	4150×10×0.45	4550×10×0.45	5270×10×0.45
2880×10×0.45	3760×10×0.45	4160×10×0.45	4555×10×0.45	5300×10×0.45
3000×10×0.45	3795×10×0.45	4200×10×0.45	4560×10×0.45	5730×16×0.45
3050×10×0.45	3850×10×0.45	4240×10×0.45	4600×10×0.45	5750×16×0.45
3100×10×0.45	3860×10×0.45	4340×10×0.45	4620×10×0.45	5280×20×0.45
3110×10×0.45	3890×10×0.45	4350×10×0.45	4700×10×0.45	5730×20×0.45
3150×10×0.45	3900×10×0.45	4400×10×0.45	4745×10×0.45	5446×20×0.45
3200×10×0.45	3960×10×0.45	4410×10×0.45	4900×10×0.45
3240×10×0.45	4000×10×0.45	4430×10×0.45	4920×10×0.45

We always bringing you the BEST



Needle plate assembly & Shuttle race assembly

for industrial sewing machines
工业缝纫机针板剪线组&梭床组



2025-2026

Industrial sewing machine spare components
工业缝纫机零配件部分



强信机械科技
STRONG H MACHINERY TECHNOLOGY

We always bringing you the BEST



Needle plate assembly & Shuttle race assembly

for industrial sewing machines
工业缝纫机针板剪线组&梭床组

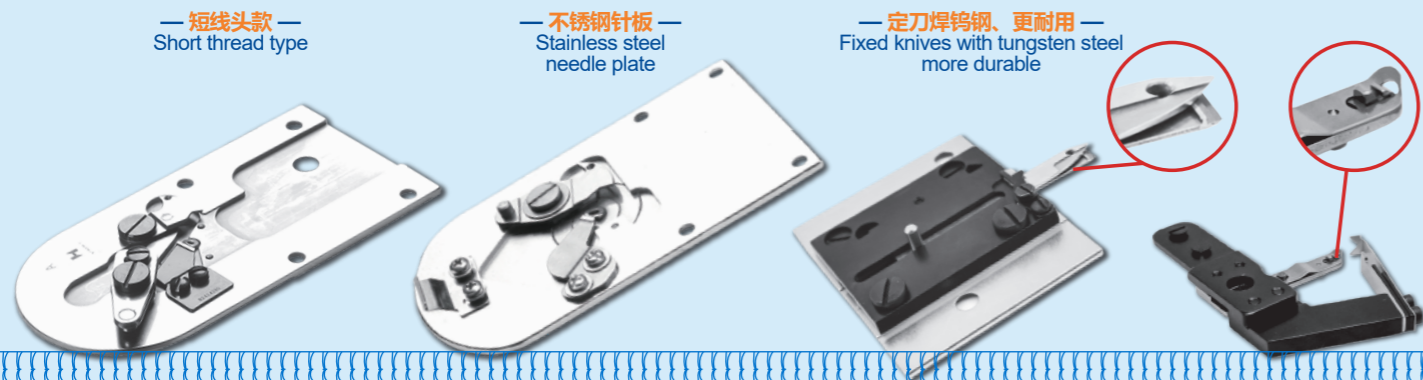

— 短线头款 —
Short thread type

— 不锈钢针板 —
Stainless steel
needle plate

— 定刀焊钨钢、更耐用 —
Fixed knives with tungsten steel
more durable

2025-2026

Industrial sewing machine spare components
工业缝纫机零配件部分



强信机械科技
STRONG H MACHINERY TECHNOLOGY

工业缝纫机针板剪线组

NEEDLE PLATE ASSEMBLY FOR INDUSTRIAL SEWING MACHINES

INDUSTRIAL SEWING MACHINES SPARE PARTS



FOR BROTHER/兄弟

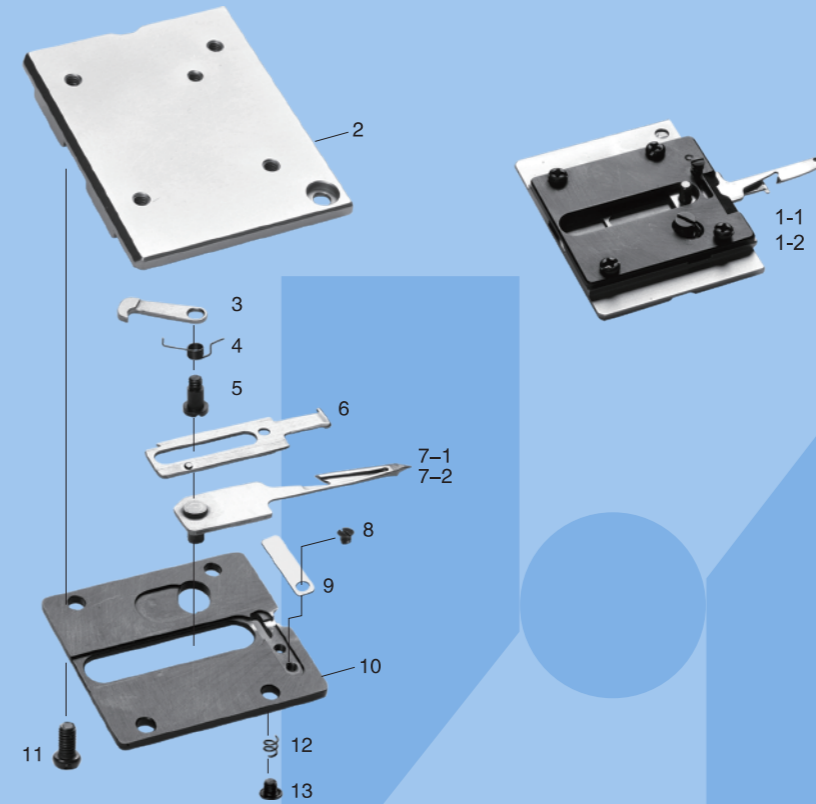

ZE-8560A剪线组件
ASSEMBLY FOR ZE-8560A

No.	Part No.	Remarks
1-1	S48236-401	match7-1
1-2	S58941-201	match7-2
2	SA8458-001	
3	S55865-001	
4	S48246-001	
5	155103001	
6	SA8459-001	
7-1	S55863-001	
7-2	S58943-001	
8	100105005	
9	S48239-001	
10	S48238-101	
11	062670712	
12	S48240-001	
13	S48247001	

FOR BROTHER/兄弟

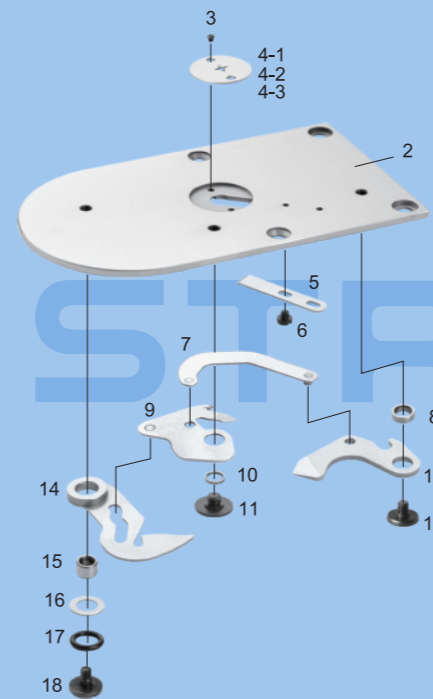

LK3-B430 剪线组件
ASSEMBLY FOR LK3-B430

No.	Part No.	Remarks
1	S18426-001	match 4-1/4-2/4-3
2	152995-001	
3	100360003	
4-1	156150-001	φ=1.8
4-2	156151-001	φ=2.2
4-3	156152-001	φ=2.5
5	152905-001	
6	111140002	
7	152897-201	
8	153220-001	
9	152901-001	
10	153219-001	
11	152904-001	
12	152981-001	
13	153222-001	
14	152906-101	
15	153597-001	
16	153596-001	
17	081008-070	
18	153598-001	

备注：可配φ1.8、φ2.2、φ2.5、φ2.6、φ2.8针孔小针板。
Remark: Can be matched needle plate size φ1.8, φ2.2, φ2.5, φ2.6, φ2.8.



工业缝纫机针板剪线组

NEEDLE PLATE ASSEMBLY FOR INDUSTRIAL SEWING MACHINES

INDUSTRIAL SEWING MACHINES SPARE PARTS

FOR BROTHER/兄弟

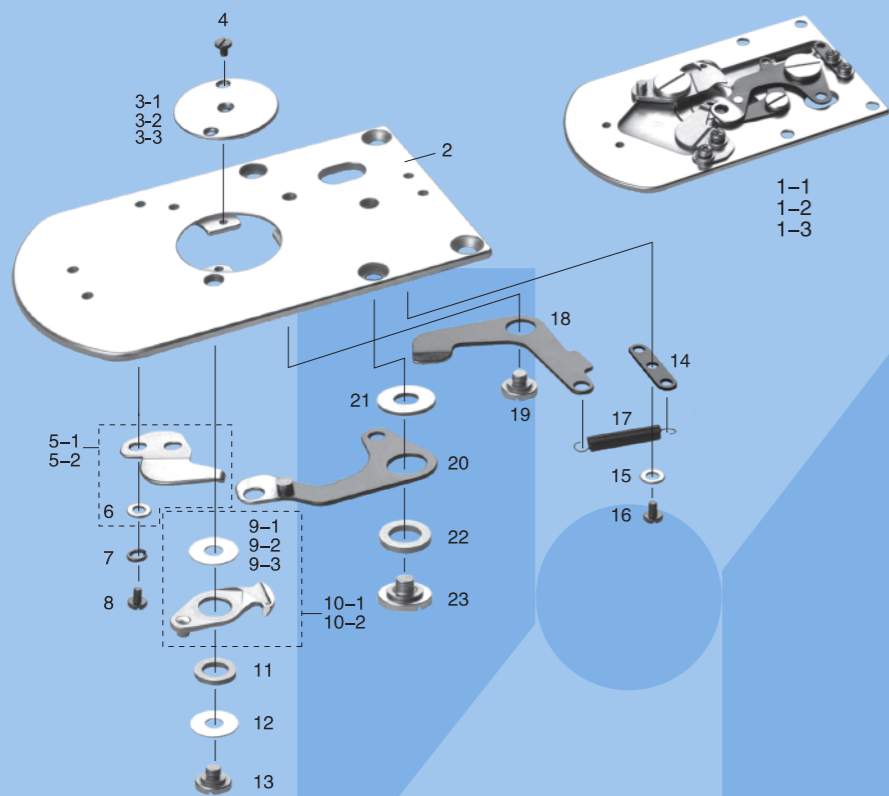

KE-430D 剪线组件 ASSEMBLY FOR KE-430D

No.	Part No.	Remarks
1-1	KE-430D(Light)	match 3-1/5-1/10-1
1-2	KE-430D(Medium)	match 3-2/5-1/10-1
1-3	KE-430D(Heavy)	match 3-3/5-2/10-2
2	SA3655-001	
3-1	SA3652-201	φ=1.6
3-2	SA3653-201	φ=2.2
3-3	SA3336-101	φ=2.4
4	100360003	
5-1	SA6597-001	
5-2	SA6431-001	
6	025030-236	
7	028030-246	
8	062300416	
9-1	SA6397-001	t=0.2
9-2	SA3334-001	t=0.3
9-3	SA6398-001	t=0.4
10-1	SA6596-001	
10-2	SA6429-001	
11	S00705-001	
12	SA4519-001	
13	SA4518-001	
14	SA3343-001	
15	025030-236	
16	062300416	
17	SA3344-001	
18	SA3341-001	
19	SA3342-001	
20	SA3337-001	
21	SA4330-001	
22	SA4329-001	
23	SA3333-001	

备注:可配φ1.6, φ1.8, φ2.0, φ2.2, φ2.4针孔小针板
Remark:Can be matched needle plate sizeφ1.6, φ1.8, φ2.0, φ2.2, φ2.4.

FOR BROTHER/兄弟

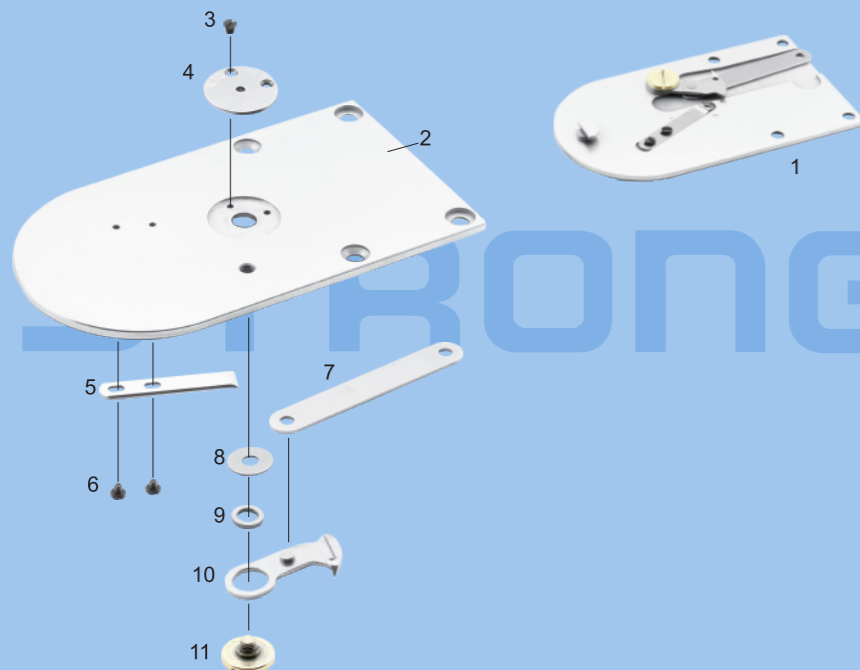

KE-430E 剪线组件 ASSEMBLY FOR KE-430E

No.	Part No.	Remarks
1	KE-430E	
2	S38015001	
3	100360003	
4	S10213101	
5	S10210201	
6	111140002	
7	S38016-001	
8	S10208005	
9	S00705001	
10	S49988001	
11	S10209101	

工业缝纫机针板剪线组

NEEDLE PLATE ASSEMBLY FOR INDUSTRIAL SEWING MACHINES

INDUSTRIAL SEWING MACHINES SPARE PARTS



FOR BROTHER/兄弟

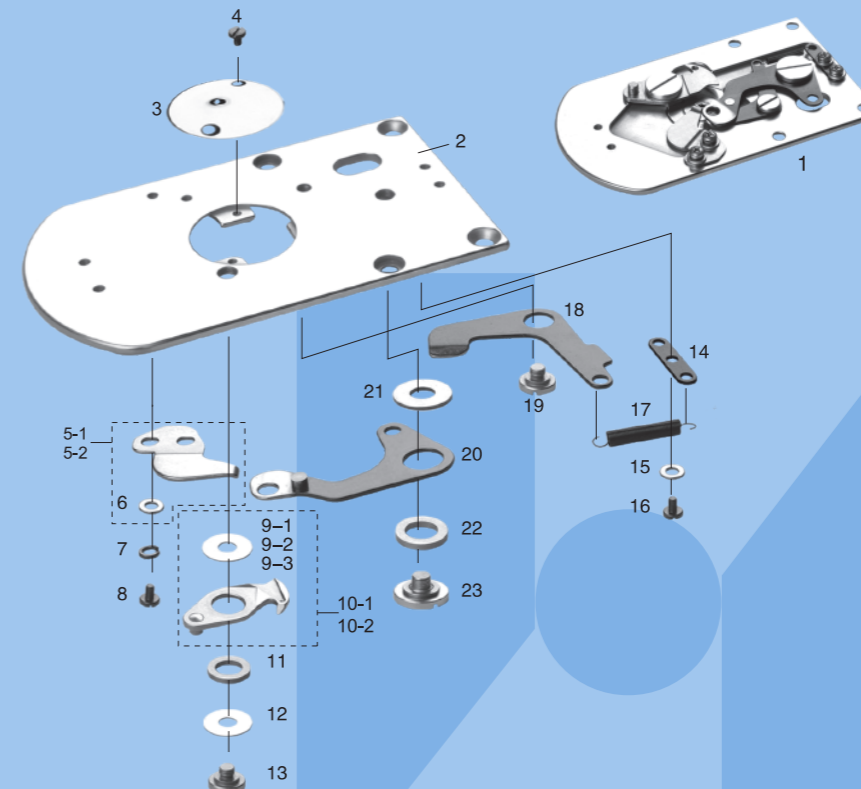

BE-438D 剪线组件 ASSEMBLY FOR BE-438D

No.	Part No.	Remarks
1	BE-438D(Light)	
2	SA3655-001	
3	SA3654-201	φ=1.6
4	100360003	
5-1	SA6431-001	
5-2	SA6597-001	
6	025032-236	
7	028030-246	
8	062300416	
9-1	SA6397-001	t=0.2
9-2	SA3334-001	t=0.3
9-3	SA6398-001	t=0.4
10-1	SA6596-001	
10-2	SA6429-001	
11	S00705-001	
12	SA4519-001	
13	SA4518-001	
14	SA3343-001	
15	025030-236	
16	062300416	
17	SA3344-001	
18	SA3341-001	
19	SA3342-001	
20	SA3337-001	
21	SA4330-001	
22	SA4320-001	
23	SA3333-001	

FOR BROTHER/兄弟

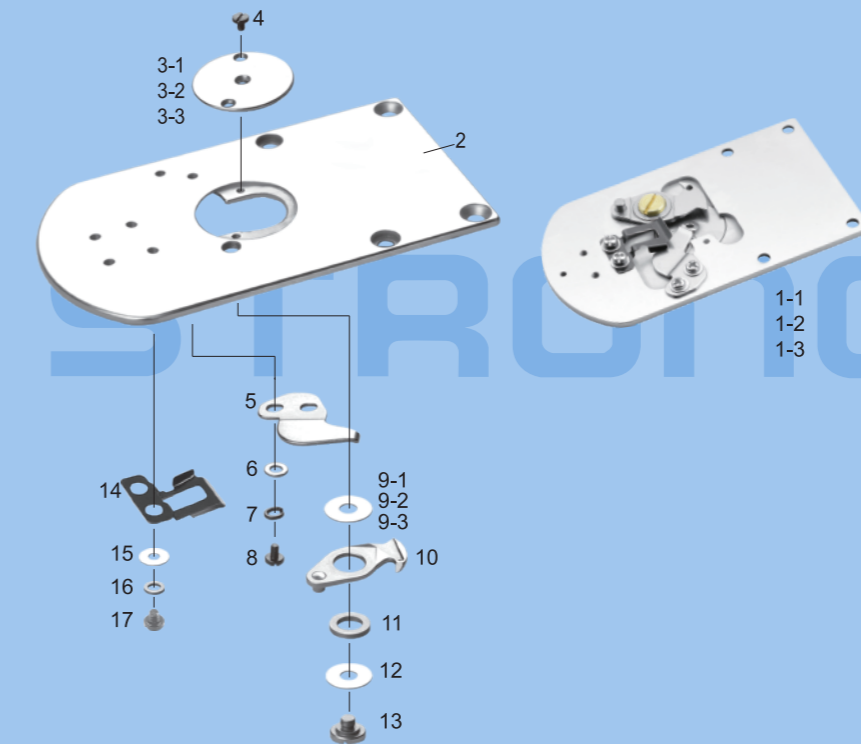

KE-430F 剪线组件 ASSEMBLY FOR KE-430F

No.	Part No.	Remarks
1-1	KE-430F(Light)	match 3-1/5-1/10-1
1-2	KE-430F(Medium)	match 3-2/5-1/10-1
1-3	KE-430F(Heavy)	match 3-3/5-2/10-2
2	SB4595-001	
3-1	SA3652-201	φ=1.6
3-2	SA3653-201	φ=2.2
3-3	SB0949-001	φ=2.4
4	100360003	
5	SB1191-001	
6	025030236	
7	028030246	
8	062300416	
9-1	SA6397-001	t=0.2
9-2	SA3334-001	t=0.3
9-3	SA6398-001	t=0.4
10	SB1189-001	
11	S00705-001	
12	SA4519-001	
13	SA4518-001	
14	SB0713-001	
15	025030236	
16	028030246	
17	062300416	

备注:可配φ1.6, φ2.2, φ2.4针孔小针板。
Remark:Can be matched needle plate sizeφ1.6, φ2.2, φ2.4.



工业缝纫机针板剪线组

NEEDLE PLATE ASSEMBLY FOR INDUSTRIAL SEWING MACHINES

INDUSTRIAL SEWING MACHINES SPARE PARTS

FOR BROTHER/兄弟

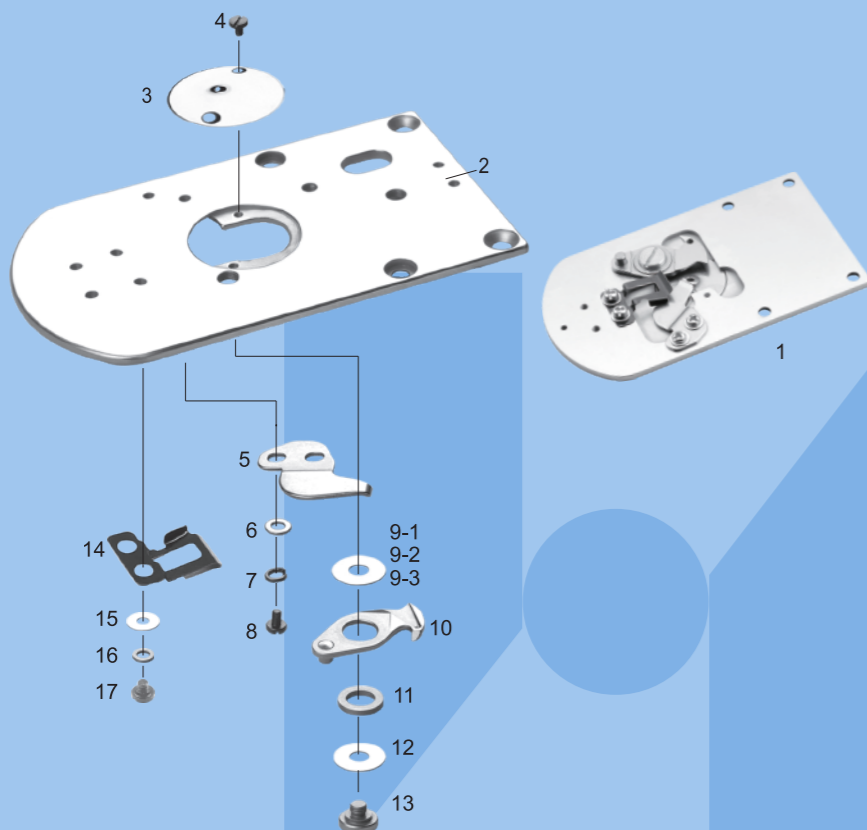

BE-438F 剪线组件 ASSEMBLY FOR BE-438F

No.	Part No.	Remarks
1	BE-438F	
2	SB4595-001	
3	SA3654-201	φ=1.6
4	100360003	
5	SB1191-001	
6	025030236	
7	028030246	
8	062300416	
9-1	SA6397-001	t=0.2
9-2	SA3334-001	t=0.3
9-3	SA6398-001	t=0.4
10	SB1189-001	
11	S00705-001	
12	SA4519-001	
13	SA4518-001	
14	SB0713-001	
15	025030236	
16	028030246	
17	062300416	

FOR BROTHER/兄弟

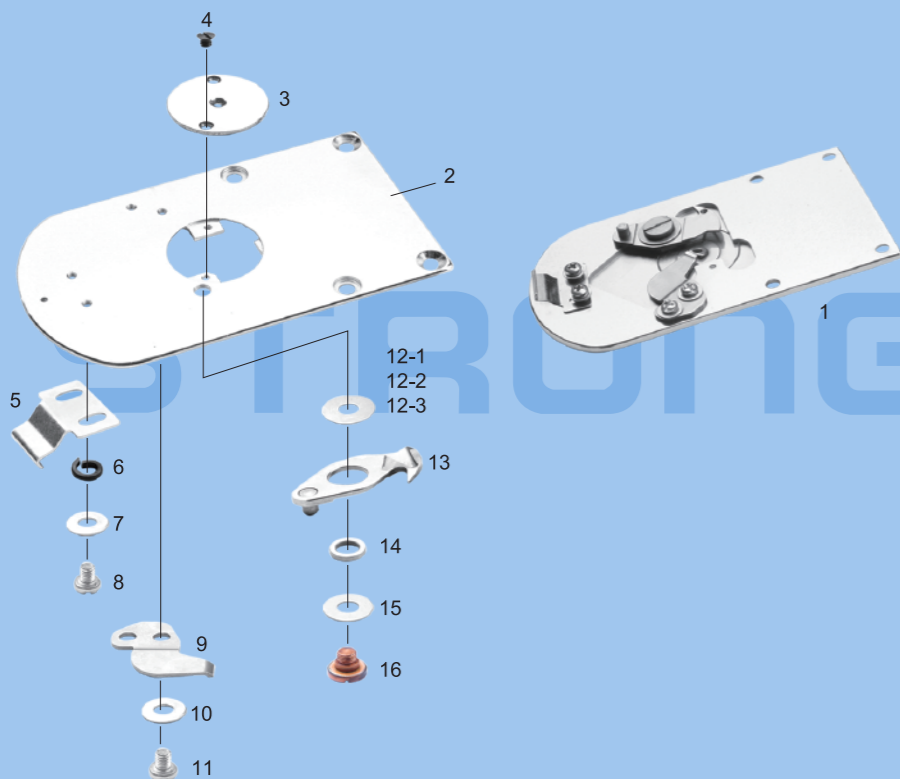

BAS-311G 剪线组件 ASSEMBLY FOR BAS-311G

No.	Part No.	Remarks
1	SA5157-000	
2	SA5157-101	
3-1	SA5221-001	φ=2.2
3-2	SA3336-101	φ=2.4
4	100360003	
5	SA6273-101	
6	028030246	
7	025030236	
8	062300416	
9	SA7944-001	
10	025030236	
11	062300416	
12-1	SA6397-001	t=0.2
12-2	SA3334-001	t=0.3
12-3	SA6398-001	t=0.4
13	SA3330-001	
14	S00705-001	
15	SA4519-001	
16	SA4518-001	

备注可配φ1.6, φ2.0, φ2.2, φ2.4针孔小针板
Remark: Can be matched needle plate size φ1.6, φ2.0, φ2.2, φ2.4.

工业缝纫机针板剪线组

NEEDLE PLATE ASSEMBLY FOR INDUSTRIAL SEWING MACHINES

INDUSTRIAL SEWING MACHINES SPARE PARTS



FOR BROTHER/兄弟

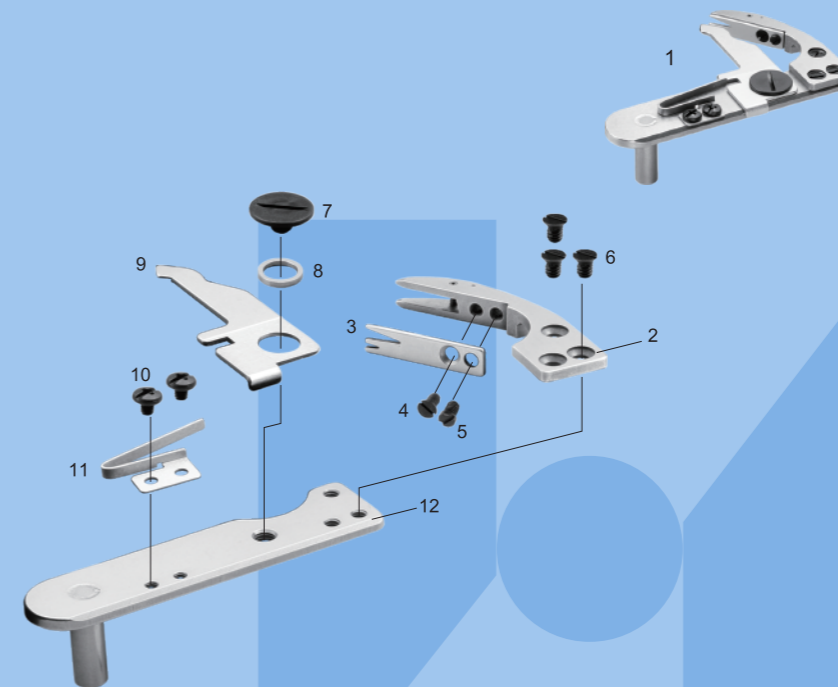

RH-9820 动刀剪线组 ASSEMBLY FOR RH-9820

No.	Part No.	Remarks
1	RH-9820-1	
2	S34899-001	
3	SA7076-001	
4	S01694001	
5	104336003	
6	141546001	
7	152904-001	
8	153219-001	
9	S34900-001	
10	060630312	
11	S34884-000	
12	S34901-001	

FOR BROTHER/兄弟

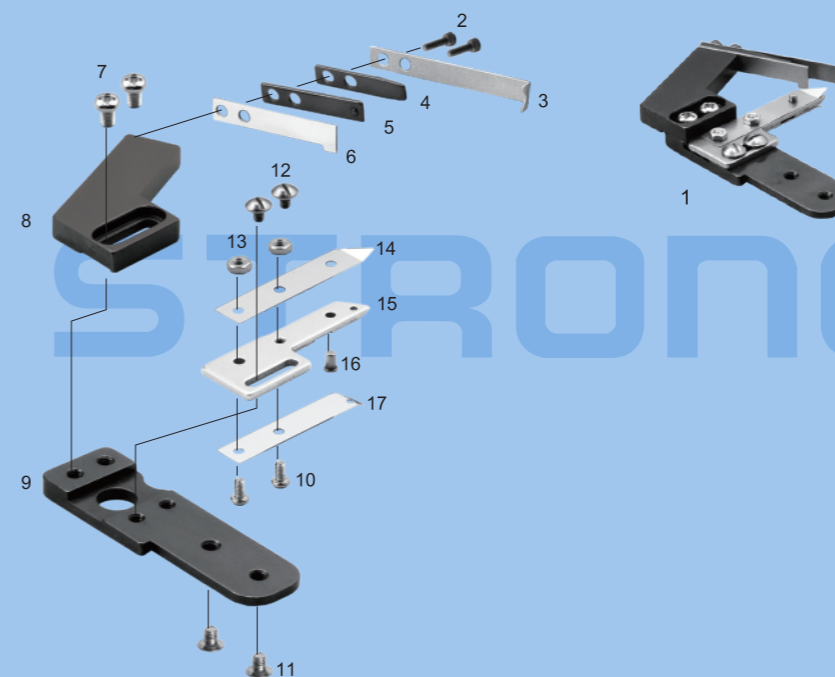

RH-9820 定刀剪线组 ASSEMBLY FOR RH-9820

No.	Part No.	Remarks
1	RH-9820-2	
2	018260-832	
3	S34894-001	
4	S34886-001	
5	S34887-001	
6	S34895-001	
7	026300-512	
8	S34893-001	
9	S34896-001	
10	062020-416	
11	061300-416	
12	542515-001T	
13	021020-106	
14	S34890-001	
15	S34888-101	
16	S34892-001	
17	S34891-101	



工业缝纫机针板剪线组

NEEDLE PLATE ASSEMBLY FOR INDUSTRIAL SEWING MACHINES

INDUSTRIAL SEWING MACHINES SPARE PARTS

FOR BROTHER/兄弟

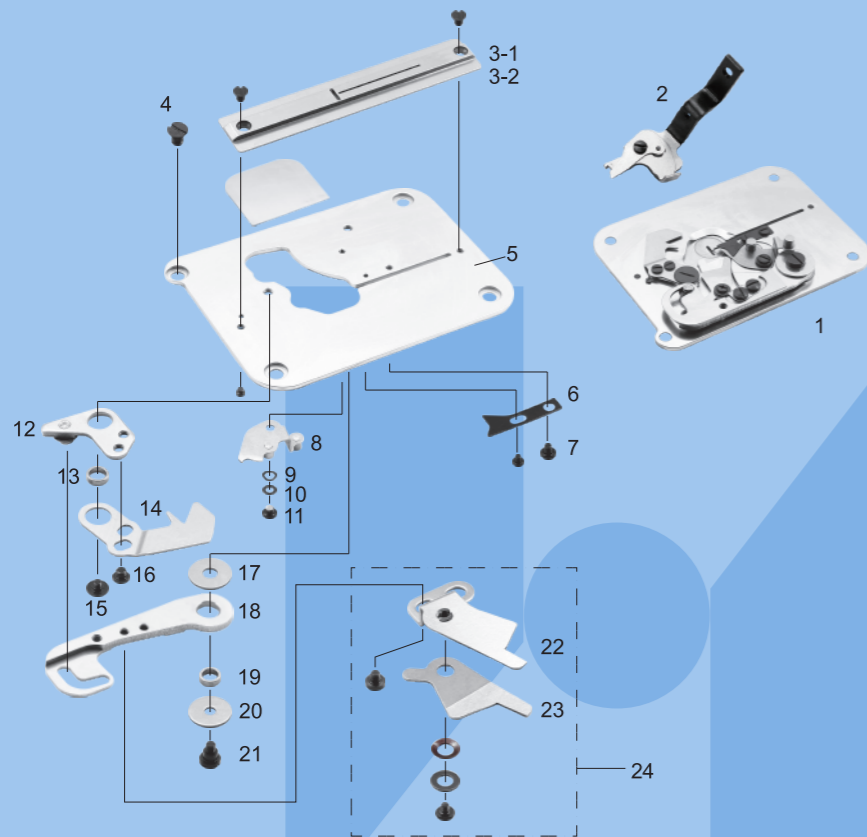

HE-800A 剪线组件 ASSEMBLY FOR HE800A

No.	Part No.	Remarks
1	S10696-001	
2	S50404-401	
3-1	S51248-101(1.2)	
3-2	S50664-001(1.4)	
4	106629002	
5	S50303-101	
6	S50270-000	
7	110215002	
8	S50256-001	
9	S5026S-001	
10	025010132	
11	141514001	
12	S50253-001	
13	S50257-001	
14	S50258-201	
15	S00712101	
16	110215002	
17	SA3001-001	
18	S50252-001	
19	S00903-001	
20	S00901-001	
21	159272001	
22	S50260-101	
23	S50263-001	
24	S50259-101	

FOR JUKI/重机

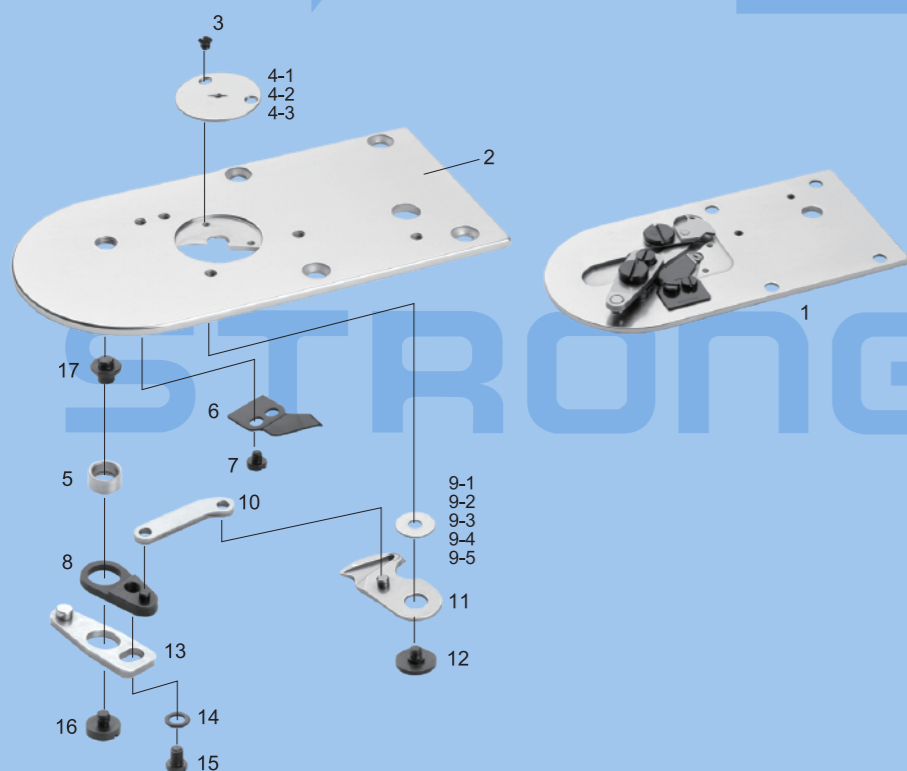

LK-1850 剪线组件 ASSEMBLY FOR LK-1850

No.	Part No.	Remarks
1	LK-1850	match 4-1/4-2/4-3
2	135-15564	
3	SS-1060210-TP	
4-1	B2426-280-000	φ=1.6
4-2	B2426-280-00B	φ=2.0
4-3	B2426-280-00C	φ=2.3
5	B2416-280-000	
6	B2424-280-000	
7	SS-7090410-SP	
8	B2415-280-0A0	
9-1	B2423-280-00A	t=0.4
9-2	B2423-280-00B	t=0.5
9-3	B2423-280-00C	t=0.6
9-4	B2423-280-00D	t=0.7
9-5	B2423-280-00E	t=0.8
10	B2418-280-000	
11	B2421-280-0A0	
12	SD-0500091-TP	
13	B2414-280-0A0	
14	WP-0450846-SP	
15	SS-7110740-TP	
16	SS-6110430-TP	
17	B2417-280-000	

备注：可配φ1.6、φ1.8、φ2.0、φ2.3、φ2.4、φ2.6、φ2.8、φ3.0针孔小针板。
Remark: Can be matched needle plate size φ1.6, φ1.8, φ2.0, φ2.3, φ2.4, φ2.6, φ2.8, φ3.0.

工业缝纫机针板剪线组

NEEDLE PLATE ASSEMBLY FOR INDUSTRIAL SEWING MACHINES

INDUSTRIAL SEWING MACHINES SPARE PARTS



FOR JUKI/重机

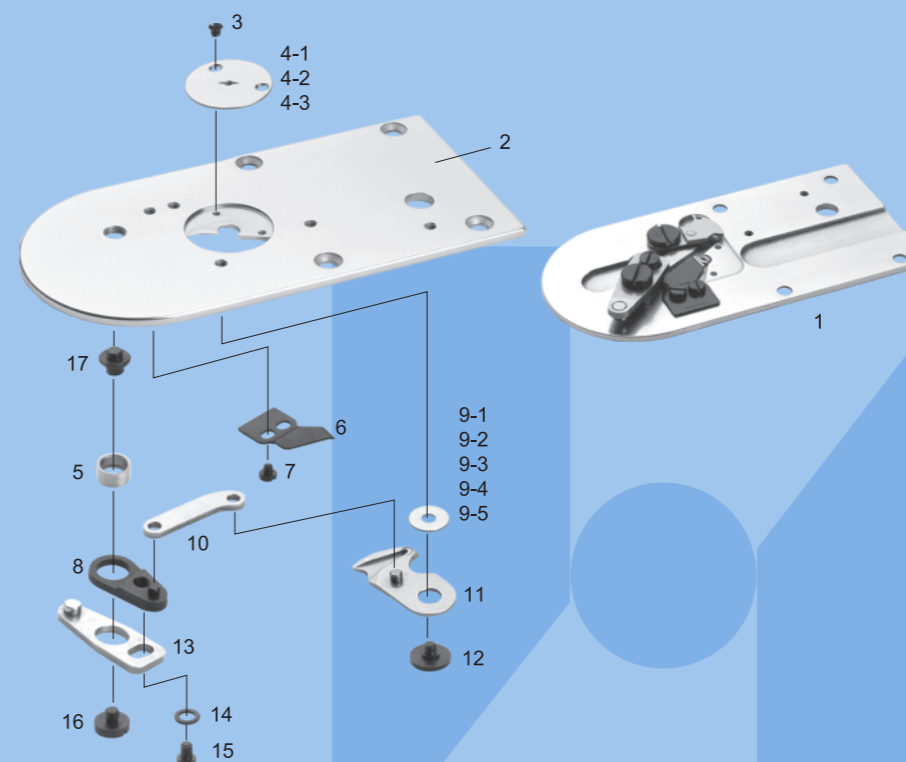

LK-1900 剪线组件 ASSEMBLY FOR LK-1900

No.	Part No.	Remarks
1	LK-1900	match 4-1/4-2/4-3
2	135-15507	
3	SS-1060210-TP	
4-1	B2426-280-000	φ=1.6
4-2	B2426-280-00B	φ=2.0
4-3	B2426-280-00C	φ=2.3
5	B2416-280-000	
6	B2424-280-000	
7	SS-7090410-SP	
8	B2415-280-0A0	
9-1	B2423-280-00A	t=0.4
9-2	B2423-280-00B	t=0.5
9-3	B2423-280-00C	t=0.6
9-4	B2423-280-00D	t=0.7
9-5	B2423-280-00E	t=0.8
10	B2418-280-000	
11	B2421-280-0A0	
12	SD-0500091-TP	
13	B2414-280-0A0	
14	WP-0450846-SP	
15	SS-7110740-TP	
16	SS-6110430-TP	
17	B2417-280-000	

备注：可配φ1.6、φ1.8、φ2.0、φ2.3、φ2.4、φ2.6、φ2.8、φ3.0针孔小针板。
Remark: Can be matched needle plate size φ1.6, φ1.8, φ2.0, φ2.3, φ2.4, φ2.6, φ2.8, φ3.0.

FOR JUKI/重机

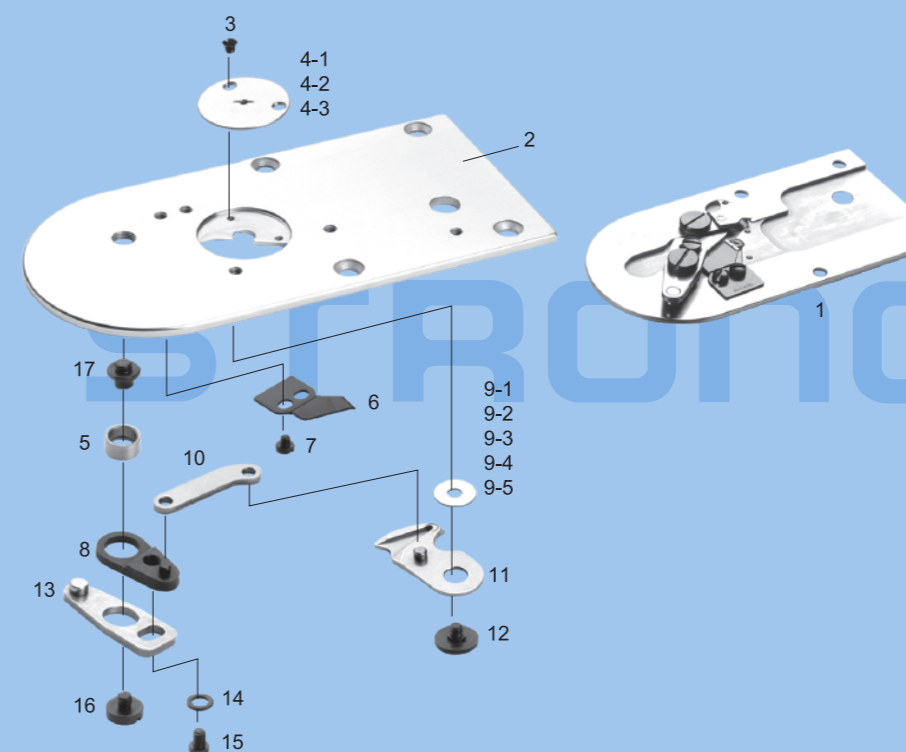

LK-1900A 剪线组件 ASSEMBLY FOR LK-1900A

No.	Part No.	Remarks
1	LK-1900A	match 4-1/4-2/4-3
2	400-06721	
3	SS-1060210-TP	
4-1	B2426-280-000	φ=1.6
4-2	B2426-280-00B	φ=2.0
4-3	B2426-280-00C	φ=2.3
5	B2416-280-000	
6	B2424-280-000	
7	SS-7090410-SP	
8	B2415-280-0A0	
9-1	B2423-280-00A	t=0.4
9-2	B2423-280-00B	t=0.5
9-3	B2423-280-00C	t=0.6
9-4	B2423-280-00D	t=0.7
9-5	B2423-280-00E	t=0.8
10	B2418-280-000	
11	B2421-280-0A0	
12	SD-0500091-TP	
13	B2414-280-0A0	
14	WP-0450846-SP	
15	SS-7110740-TP	
16	SS-6110430-TP	
17	B2417-280-000	

备注：可配φ1.6、φ2.0、φ2.3、φ2.4、φ2.6、φ2.8针孔小针板。
Remark: Can be matched needle plate size φ1.6, φ2.0, φ2.3, φ2.4, φ2.6, φ2.8.



工业缝纫机针板剪线组

NEEDLE PLATE ASSEMBLY FOR INDUSTRIAL SEWING MACHINES

INDUSTRIAL SEWING MACHINES SPARE PARTS

FOR JUKI/重机

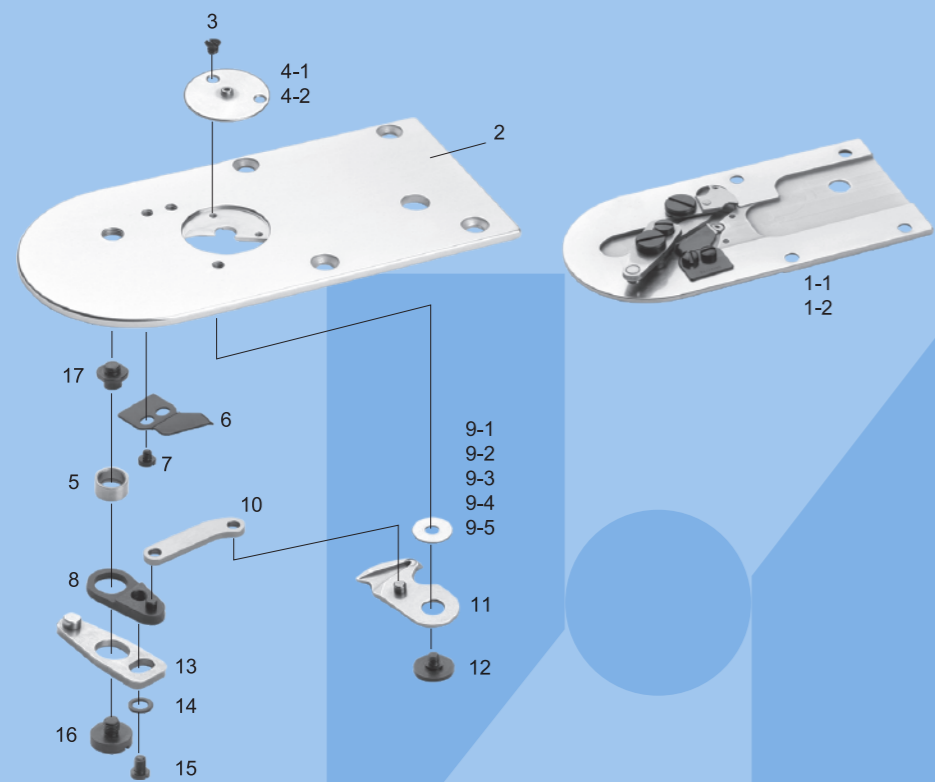

LK-1903A 剪线组件 ASSEMBLY FOR LK-1903A

No.	Part No.	Remarks
1-1	400-06725	
1-2	400-06726	
2	400-06721	
3	SS-1060210-TP	
4-1	MAZ-15801000	φ=1.6
4-2	MAZ-15601000	φ=2.0
5	B2416-280-000	
6	B2424-280-000	
7	SS-7090410-SP	
8	B2415-280-0A0	
9-1	B2423-280-00A	t=0.4
9-2	B2423-280-00B	t=0.5
9-3	B2423-280-00C	t=0.6
9-4	B2423-280-00D	t=0.7
9-5	B2423-280-00E	t=0.8
10	B2418-280-000	
11	B2421-280-0A0	
12	SD-0500091-TP	
13	B2414-280-0A0	
14	WP-0450846-SP	
15	SS-6110430-TP	
16	B2417-280-000	
17	B2417-280-000	

备注: 可配φ1.6、φ2.0针孔小针板。
Remark: Can be matched needle plate sizeφ1.6, φ2.0.

FOR JUKI/重机

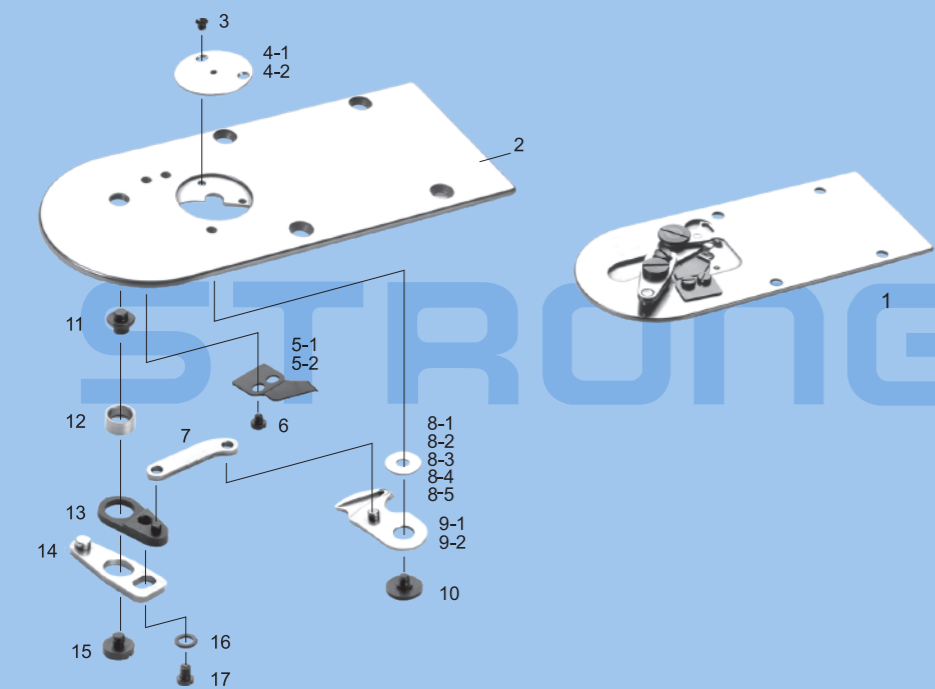

LK-1910/1920 剪线组件 ASSEMBLY FOR LK-1910/1920

No.	Part No.	Remarks
1	LK1910/LK1920	match 4-1/4-2
2	142-13003	
3	SS-1060210-TP	
4-1	D2426-284-M00	φ=1.6
4-2	141-09607	φ=2.3
5-1	B2424-280-000	
5-2	B2424-210-000(Heavy)	
6	SS-7090410-SP	
7	B2418-280-000	
8-1	B2423-280-00A	t=0.4
8-2	B2423-280-00B	t=0.5
8-3	B2423-280-00C	t=0.6
8-4	B2423-280-00D	t=0.7
8-5	B2423-280-00E	t=0.8
9-1	B2421-280-0A0	
9-2	B2421-210-AA0(Heavy)	
10	SD-0500091-TP	
11	B2417-280-000	
12	B2416-280-000	
13	B2416-210-DA0	
14	B2414-280-000	
15	SS-6110430-TP	
16	WP-0450846-SP	
17	SS-7110740-TP	

备注: 可配φ1.6、φ1.8、φ2.0、φ2.3、φ2.4
针孔小针板。
Remark: Can be matched needle plate sizeφ1.6, φ1.8, φ2.0, φ2.3, φ2.4.

工业缝纫机针板剪线组

NEEDLE PLATE ASSEMBLY FOR INDUSTRIAL SEWING MACHINES

INDUSTRIAL SEWING MACHINES SPARE PARTS



FOR JUKI/重机

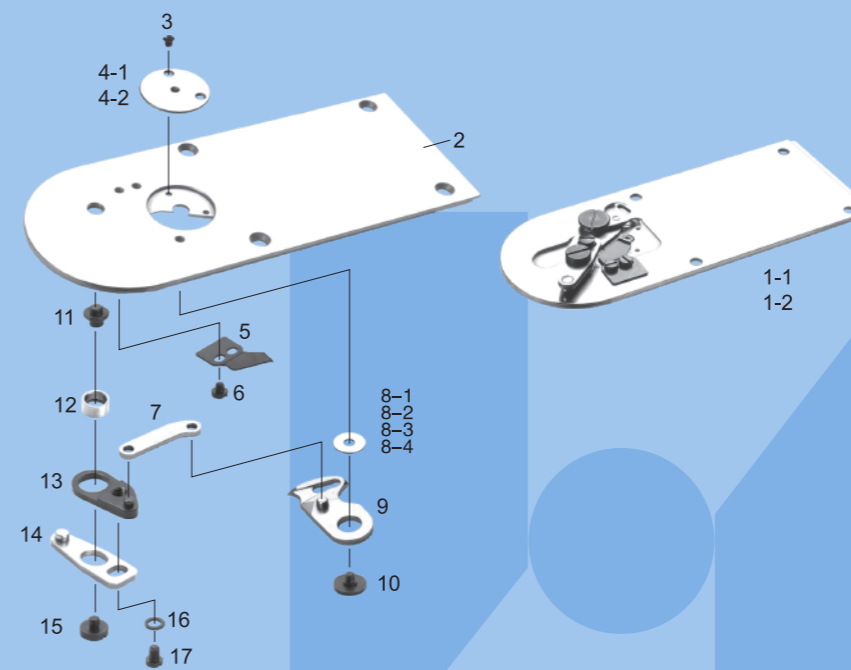

AMS-210D 剪线组件 ASSEMBLY FOR AMS-210D

No.	Part No.	Remarks
1-1	B2425-210-DAA	
1-2	B2425-210-DAB	
2	B2425-210-000	
3	SS-1060210-TP	
4-1	B2426-210-00A	φ=1.6
4-2	B2426-210-00B	φ=2.0
5	B2424-210-000	
6	SS-7090410-SP	
7	B2418-280-000	
8-1	B2423-280-00A	t=0.4
8-2	B2423-280-00B	t=0.5
8-3	B2423-280-00C	t=0.6
8-4	B2423-280-00D	t=0.7
9	B2421-210-AA0	
10	B2417-210-000	
11	B2417-280-000	
12	B2416-280-000	
13	B2416-210-0A0	
14	B2414-280-0A0	
15	SS-6110430-TP	
16	WP-0450846-SP	
17	SS-7110740-TP	

备注: 可配φ1.6、φ2.0、φ2.4、φ2.8、φ3.0针孔小针板。
Remark: Can be matched needle plate sizeφ1.6, φ2.0, φ2.4, φ2.8, φ3.0.

FOR JUKI/重机

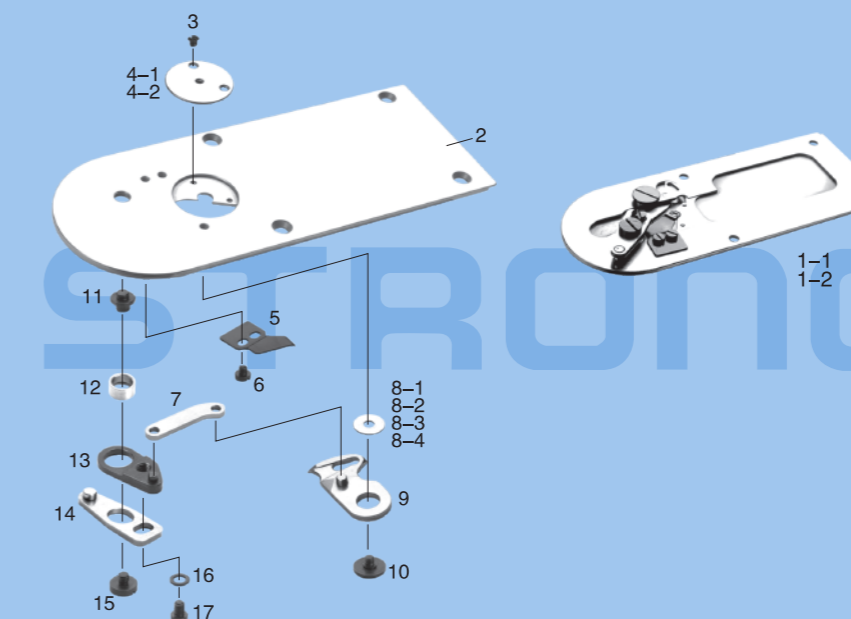

AMS-210E 剪线组件 ASSEMBLY FOR AMS-210E

No.	Part No.	Remarks
1-1	40030932	
1-2	40030933	
2	40030934	
3	SS-1060210-TP	
4-1	B2426-210-00A	φ=1.6
4-2	B2426-210-00B	φ=2.0
5	B2424-240-000	
6	SS-7090410-SP	
7	B2418-280-000	
8-1	B2423-280-00A	t=0.4
8-2	B2423-280-00B	t=0.5
8-3	B2423-280-00C	t=0.6
8-4	B2423-280-00D	t=0.7
9	B2421-210-AA0	
10	B2417-210-000	
11	B2417-280-000	
12	B2416-280-000	
13	B2416-210-0A0	
14	B2414-280-0A0	
15	SS-6110430-TP	
16	WP-0450846-SP	
17	SS-7110740-TP	

备注: 可配φ1.6、φ2.0、φ3.0针孔小针板。
Remark: Can be matched needle plate sizeφ1.6, φ2.0, φ3.0.

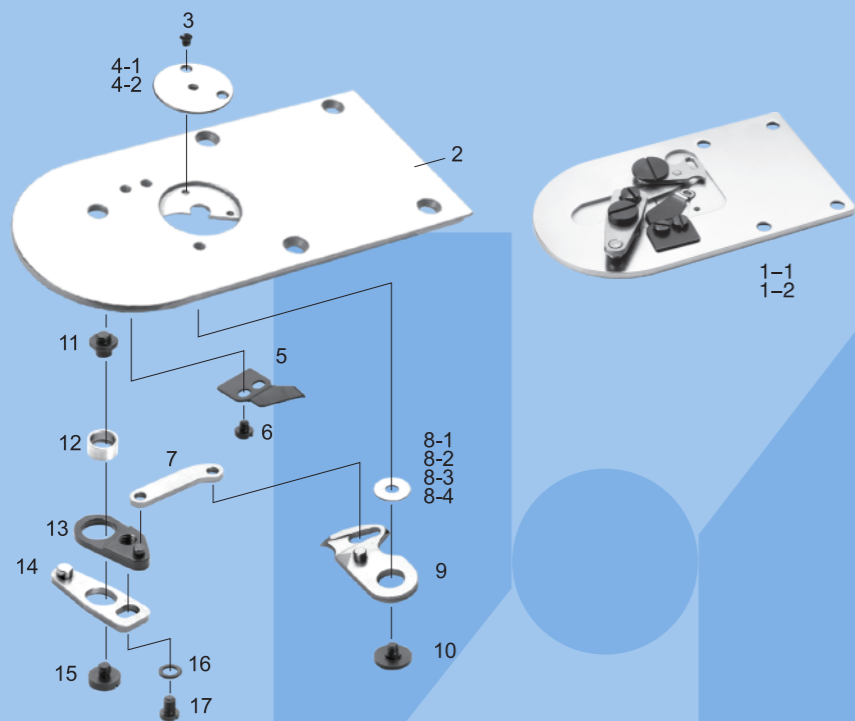

AMS-215D 剪线组件
ASSEMBLY FOR AMS-215D

No.	Part No.	Remarks
1-1	B2425-221-DAA	match4-1
1-2	B2425-221-DAB	match4-2
2	B2425-215-P00	
3	SS-1060210-TP	
4-1	B2426-210-00A	φ=1.6
4-2	B2426-210-00B	φ=2.0
5	B2424-210-000	
6	SS-7090410-SP	
7	B2418-280-000	
8-1	B2423-280-00A	t=0.4
8-2	B2423-280-00B	t=0.5
8-3	B2423-280-00C	t=0.6
8-4	B2423-280-00D	t=0.7
9	B2421-210-AA0	
10	B2417-210-000	
11	B2417-280-000	
12	B2416-280-000	
13	B2416-210-0A0	
14	B2414-280-0A0	
15	SS-6110430-TP	
16	WP-0450846-SP	
17	SS-7110740-TP	

备注:可配φ1.6、φ2.0、φ2.8、φ3.0针孔小针板。
Remark: Can be matched needle plate size φ1.6, φ2.0, φ2.8, φ3.0.

FOR JUKI/重机

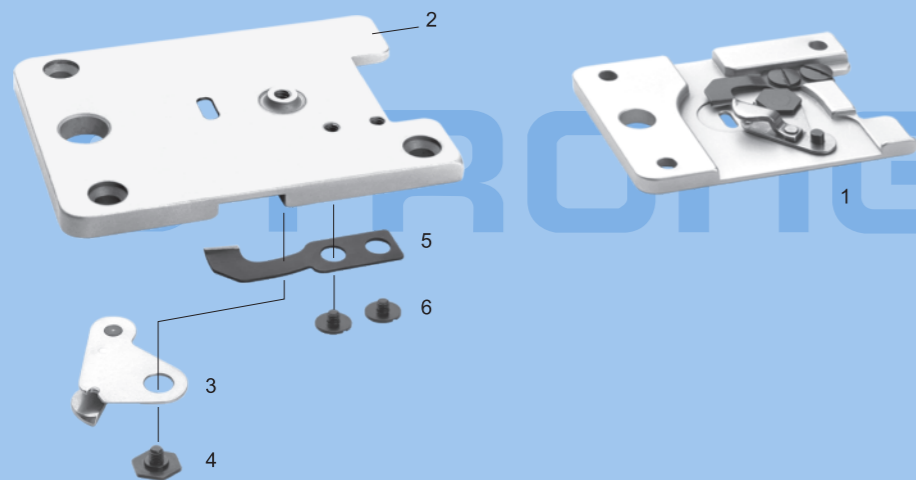

MB-373 剪线组件
ASSEMBLY FOR MB-373

No.	Part No.	Remarks
1	B1241-373-0B0	
2	B1241-373-000	
3	B2406-373-0A0	
4	SD-0600095-TH	
5	B2410-373-000	
6	SS-7080310-SP	

FOR JUKI/重机

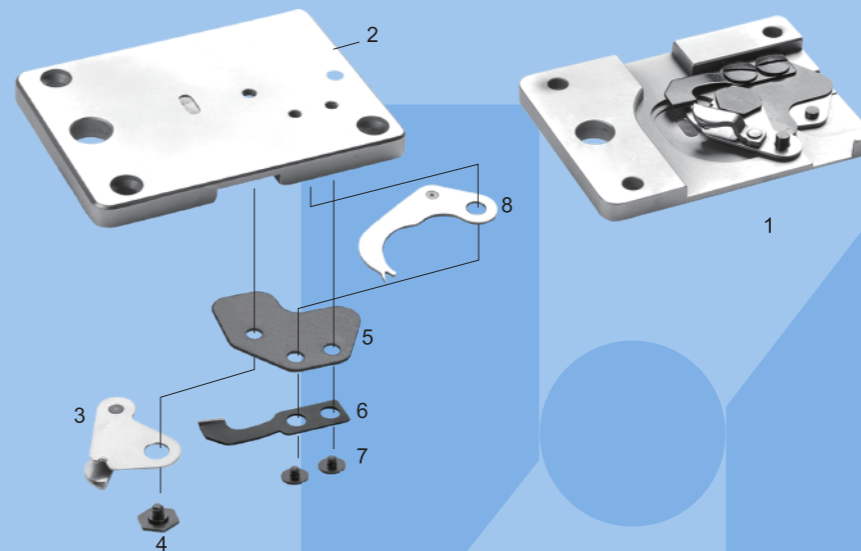

MB-377 剪线组件
ASSEMBLY FOR MB-377

No.	Part No.	Remarks
1	B1241-377-0B0	
2	B1241-377-000	
3	B2406-373-0A0	
4	SD-0600095-TH	
5	B2702-377-000	
6	B2410-373-000	
7	SS-7080310-SP	
8	S2703-377-0A0	

FOR JUKI/重机

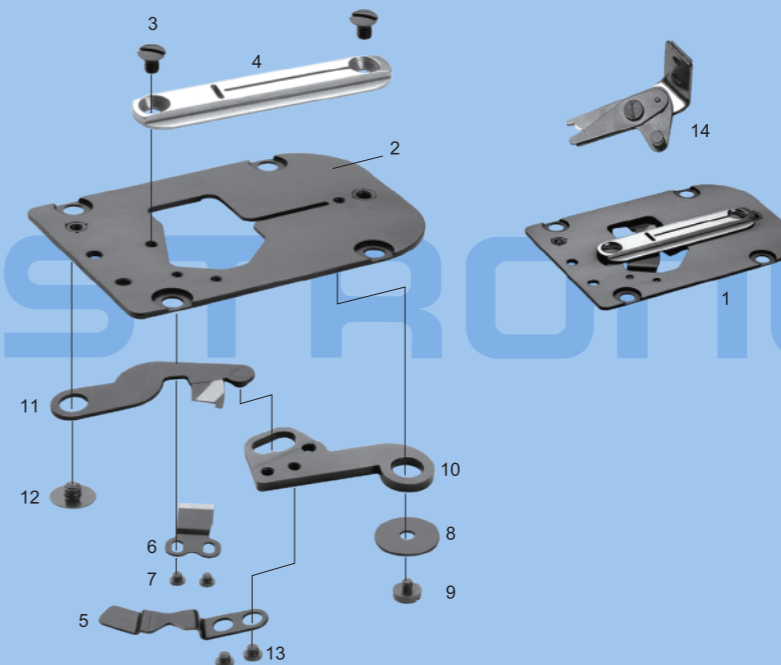

LBH-780 剪线组件
ASSEMBLY FOR LBH-780

No.	Part No.	Remarks
1	B2401-771-0A0	
2	B2401-771-0B0	
3	SS-2090510-SP	
4	B2402-771-000	
5	B2405-771-000	
6	B2408-771-000-A	
7	SS-4080310-SP	
8	WP-0451016-SP	
9	SS-7110570-SP	
10	B2404-771-000	
11	B2406-771-0A0	
12	SS-5090320-SP	
13	SS-6090440-SP	
14	B2001-771-0A0	

FOR JUKI/重机

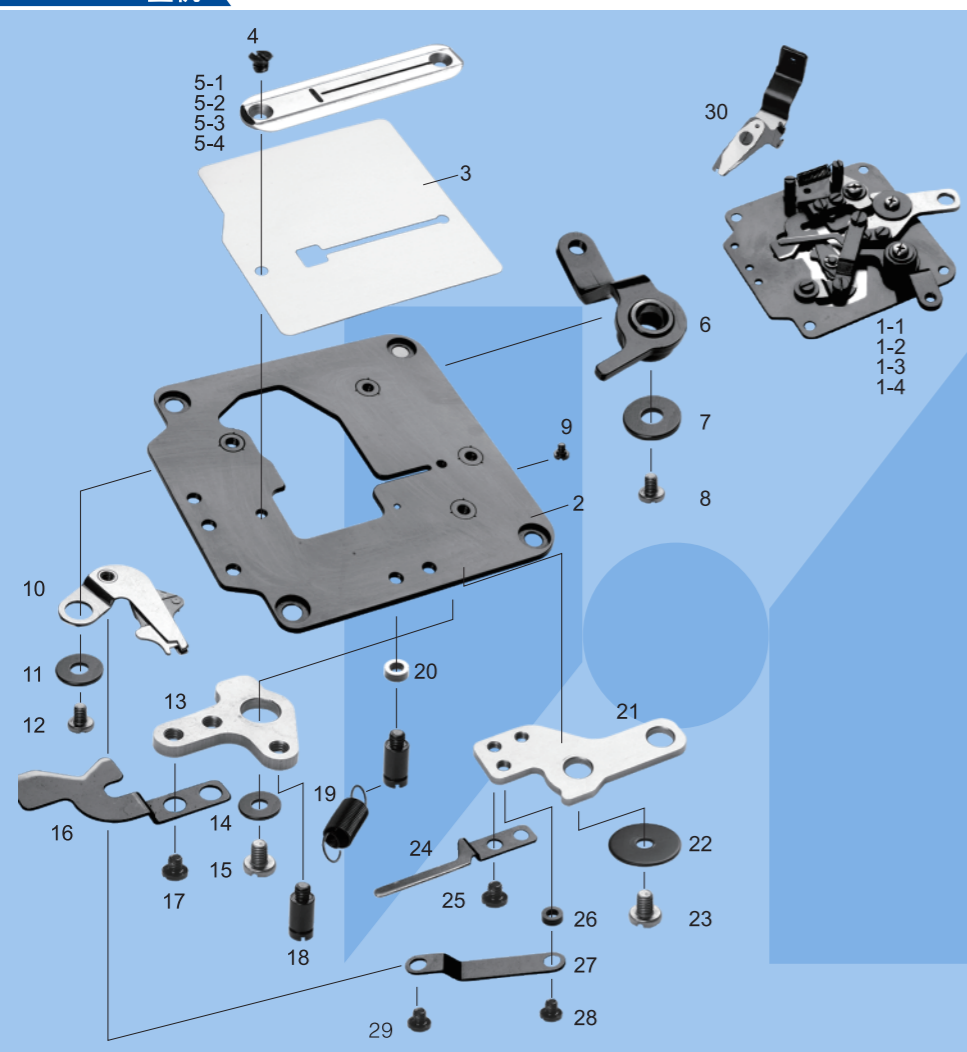

LBH-1790 剪线组
ASSEMBLY FOR LBH-1790

No.	Part No.	Remarks
1-1	400-27553	
1-2	400-27554	
1-3	400-04300	match5-1
1-4	400-04370	match5-2
2	400-04301	
3	400-04324	
4	SM-1030400-SP	
5-1	400-27553	1.4×6.2
5-2	400-27554	1.2×6.2
5-3	400-04350	
5-4	400-04352	
6	400-04321	
7	WP-0431005-SP	
8	SM-6040450-TP	
9	SD-0250101-SP	
10	400-04311	
11	WP-0431005-SP	
12	SM-6040450-TP	
13	400-04309	
14	WP-0431005-SP	
15	SM-5040655-SP	
16	400-22323	
17	SM-6040450-TP	
18	400-04327	
19	400-29613	
20	B1623-180-000	
21	400-04306	
22	WP-0451016-SP	
23	SM-5040655-SP	
24	400-22322	
25	SM-6040450-TP	
26	B3013-141-H0A	
27	400-04308	
28	SD-0500167-TP	
29	SD-0500166-TP	
30	400-04255	

FOR JUKI/重机

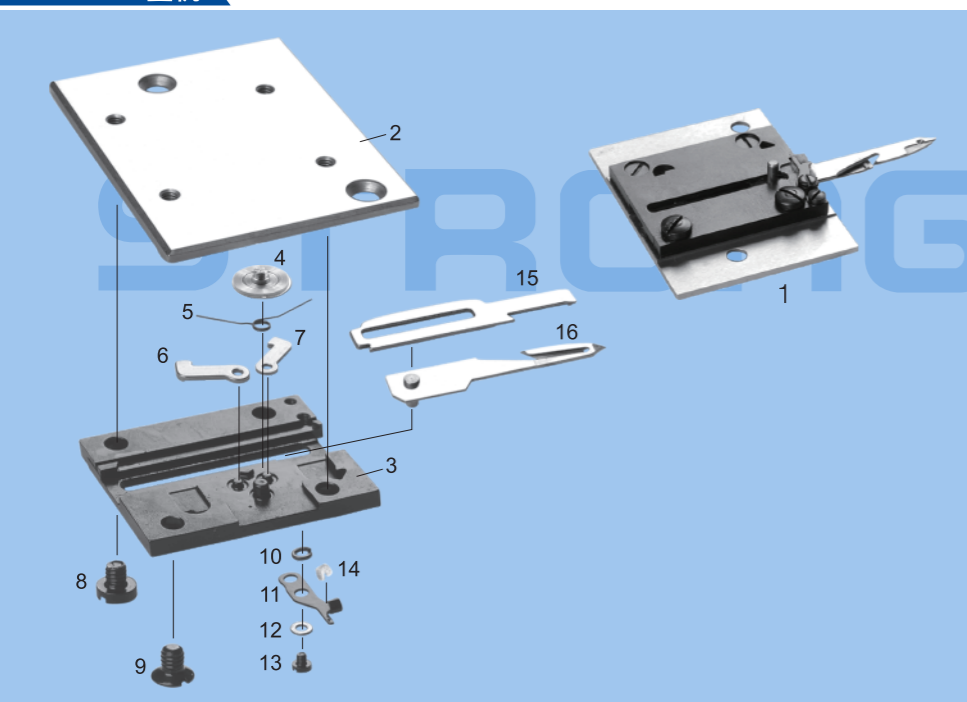

LZ-2290 剪线组件
ASSEMBLY FOR LZ-2290

No.	Part No.	Remarks
1	225-57458	
2	225-58308	
3	225-58407	
4	NP-2103000-00	
5	225-58209	
6	225-57904	
7	225-57805	
8	SS-7090610-SP	
9	SS-1090510-SP	
10	D2056-772-B0B	
11	225-58100	
12	WS-027002-KN	
13	SS-7060310-SP	
14	225-58001	
15	225-57706	
16	225-57557	

FOR JUKI/重机

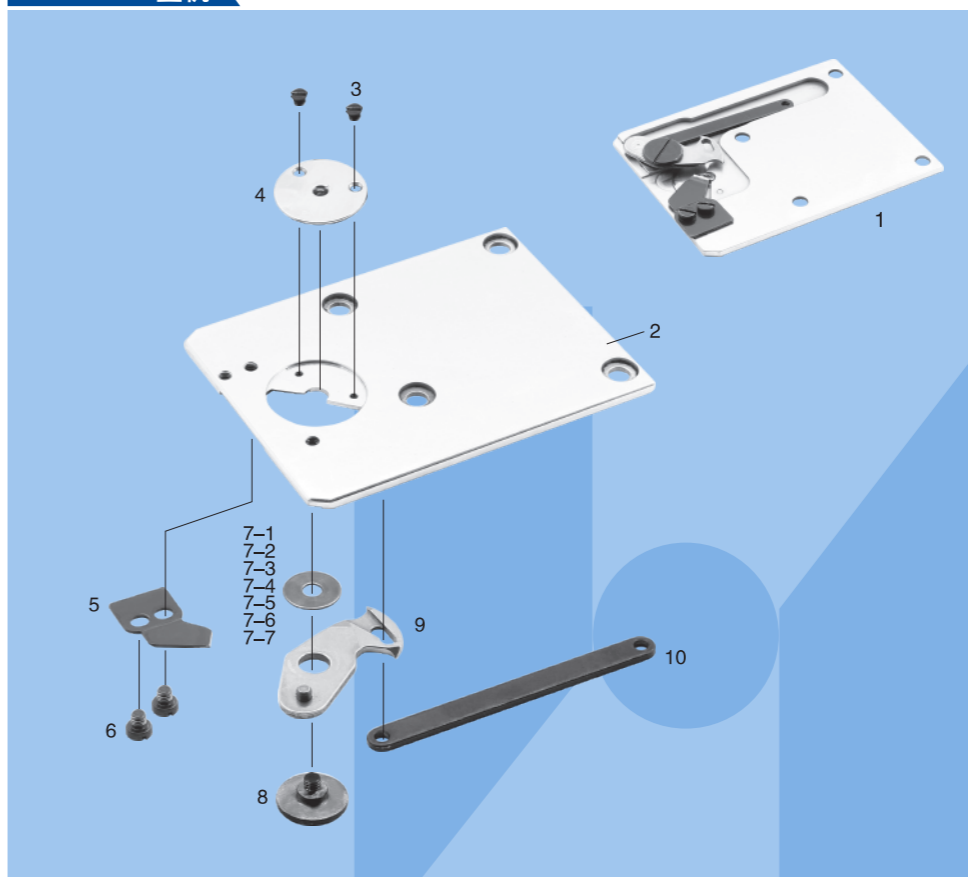

MOL-254 前剪线组件
ASSEMBLY FOR MOL-254

No.	Part No.	Remarks
1		
2	138-86304	
3	SS-1060210-TP	
4	138-82501	
5	B2424-210-000	
6	SS-7090410-SP	
7-1	B2423-280-00A	t=0.4
7-2	B2423-280-00B	t=0.5
7-3	B2423-280-00C	t=0.6
7-4	B2423-280-00D	t=0.7
7-5	B2423-280-00E	t=0.8
7-6	B2423-280-00F	t=0.65
7-7	B2423-280-00G	t=0.75
8	B2417-210-000	
9	138-81255	
10	138-87302	

FOR JUKI/重机

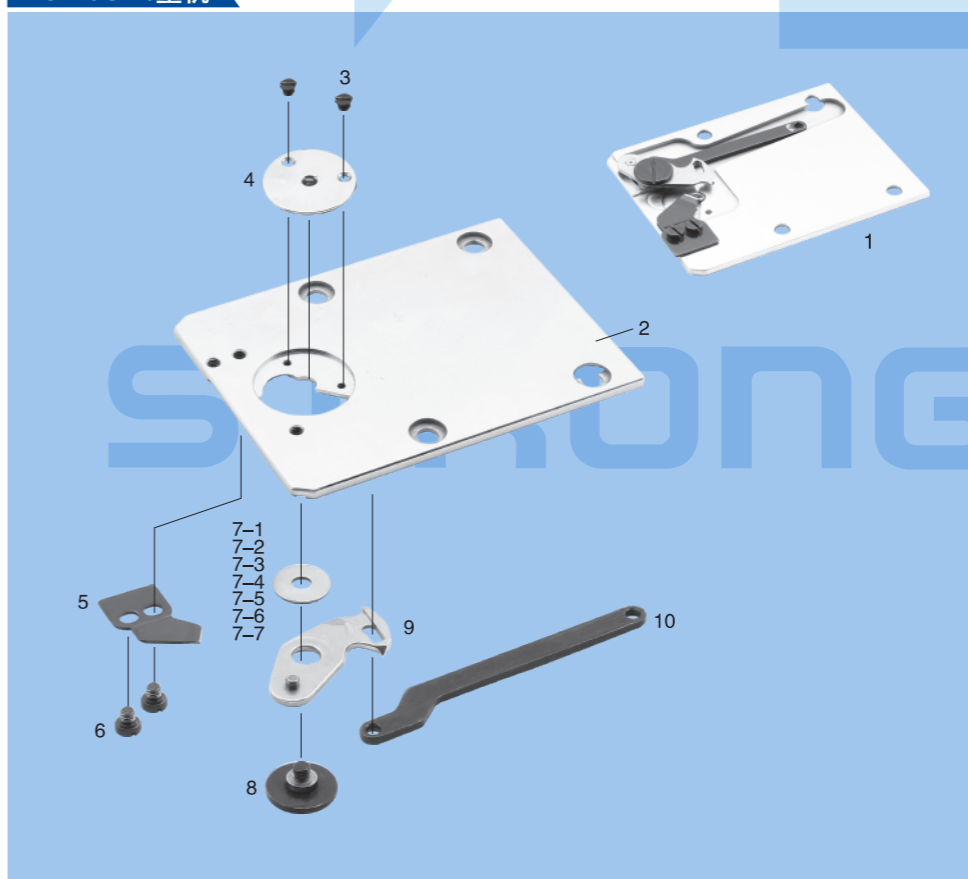

MOL-254 后剪线组件
ASSEMBLY FOR MOL-254

No.	Part No.	Remarks
1		
2	144-12506	
3	SS-1060210-TP	
4	138-82501	
5	B2424-210-000	
6	SS-7090410-SP	
7-1	B2423-280-00A	t=0.4
7-2	B2423-280-00B	t=0.5
7-3	B2423-280-00C	t=0.6
7-4	B2423-280-00D	t=0.7
7-5	B2423-280-00E	t=0.8
7-6	B2423-280-00F	t=0.65
7-7	B2423-280-00G	t=0.75
8	B2417-210-000	
9	138-81255	
10	138-82105	



工业缝纫机针板剪线组

NEEDLE PLATE ASSEMBLY FOR INDUSTRIAL SEWING MACHINES

INDUSTRIAL SEWING MACHINES SPARE PARTS

FOR MITSUBISU/三菱

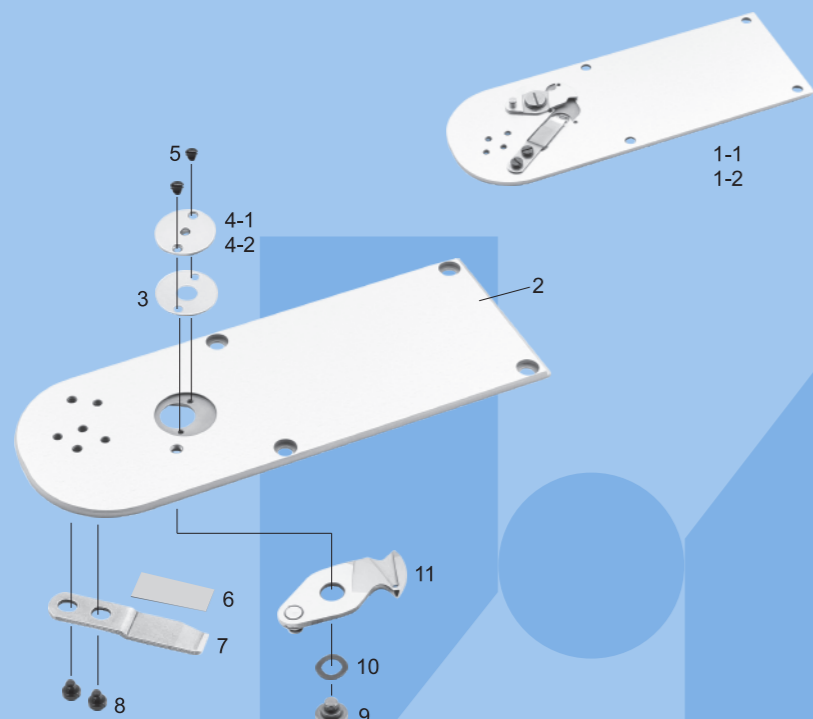

PLK-1006 剪线组件 ASSEMBLY FOR PLK-1006

No.	Part No.	Remarks
1-1	PLK1006	φ=1.6
1-2	PLK1006	φ=3.0
2	MS01A0472	
3	MS01A1476	
4-1	MS03A1-101	
4-2	MS03A1-101(1.6)	
5	M90605010	
6	MA10B2476	
7	MS03A0838	
8	M90906003	
9	M91129015	
10	M96004052	
11	MS03B0838	

FOR SUN STAR/日星

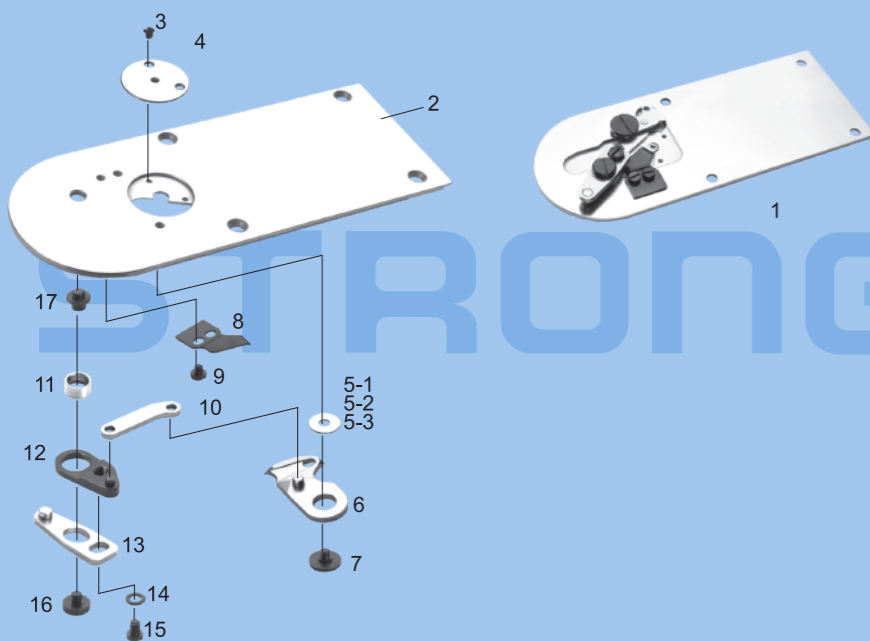

SPA/A-1306-HS 剪线组件 ASSEMBLY FOR SPA/A-1306-HS

No.	Part No.	Remarks
1	1306	
2	10S040S-306H	
3	04007SC-5030	
4	10S042S-306H	
5-1	10-054W-120H	t=0.5
5-2	10-051W-120H	t=0.6
5-3	10-052W-120H	t=0.7
6	10S047S-306H	
7	10S048S-306H	
8	10S045S-306H	
9	10S046S-306H	
10	10S053S-306H	
11	10S057S-306H	
12	GD-036239-00	
13	10S058S-306H	
14	WP-0450846-SP	
15	SS-7110740-TP	
16	10S060S-306H	
17	10S056S-306H	

备注：可配φ1.6、φ2.0针孔小针板。
Remark: Can be matched needle plate size φ1.6, φ2.0.

工业缝纫机针板剪线组

NEEDLE PLATE ASSEMBLY FOR INDUSTRIAL SEWING MACHINES

INDUSTRIAL SEWING MACHINES SPARE PARTS



FOR YAMATO/大和

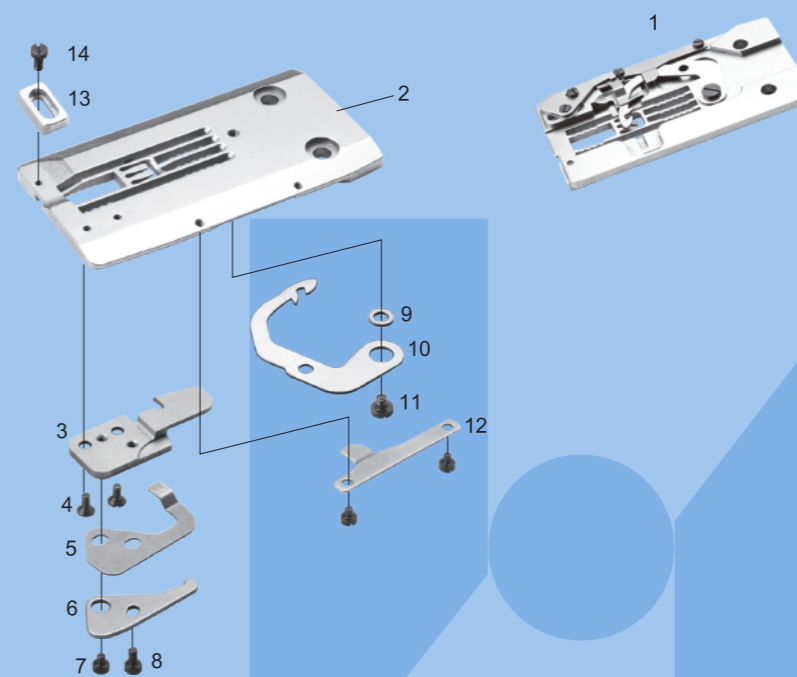

VT1500 剪线组 ASSEMBLY FOR VT1500

No.	Part No.	Remarks
1	6508088	
2	6508077	
3	6500456	
4	130005	
5	6500457	
6	6500458	
7	110034	
8	110023	
9	6500443	
10	6500455	
11	110054	
12	6500459	
13	6500442	
14	110023	

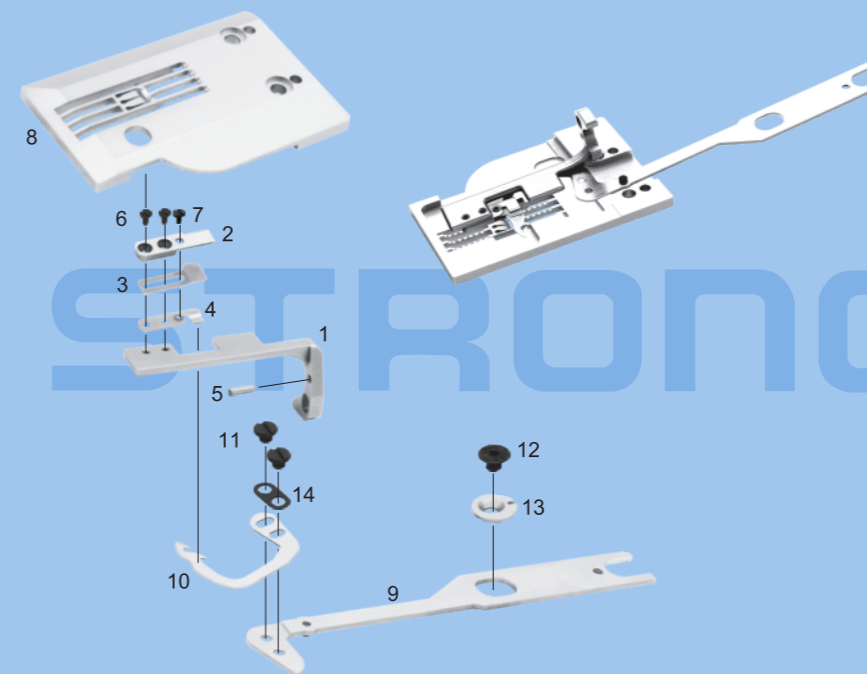

VT1500 剪线组 ASSEMBLY FOR VT1500

No.	Part No.	Remarks
1	KE496-1	
2	KE496-3	
3	KE496-4	
4	KE496-5	
5	PM20C	
6	TE1232	
7	TE1962.A	
8	VT1500EAUT-001	
9	VT1500EAUT-004-2	
10	KE496-2	
11	TE1273	
12	GB/T70.3-M4X8-12.9-FH	
13	TE3009	
14	VT1500EAUT_004-5	



工业缝纫机梭床组

SHUTTLE RACE ASSEMBLY FOR INDUSTRIAL SEWING MACHINES

INDUSTRIAL SEWING MACHINES SPARE PARTS

FOR BROTHER/兄弟

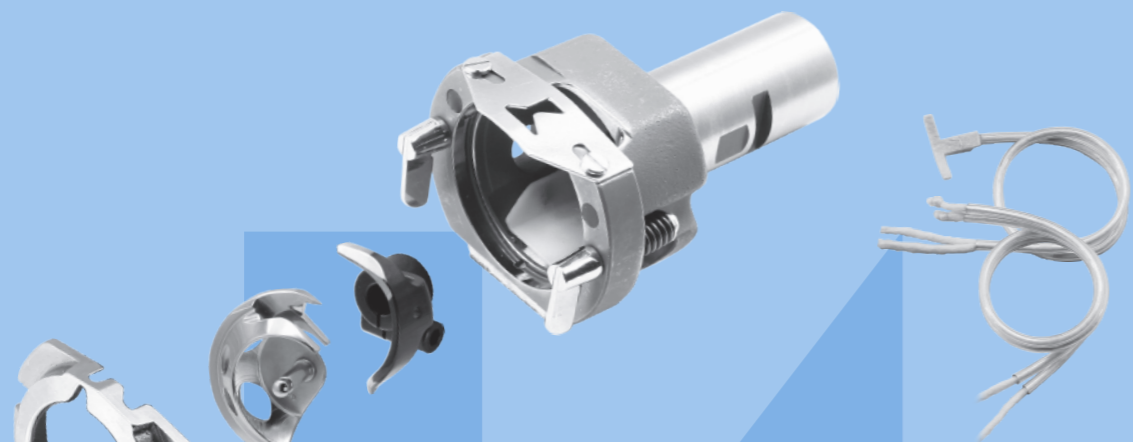

机型 Model	梭床组 Shuttle Race Assembly	梭托 Shuttle Driver	摆梭 Shuttle Hook		梭床盖 Shuttle Race Cover	
			中厚料 Medium	厚料 Heavy	中厚料 Medium	厚料 Heavy
KE-430D	SA3239-301	SA3284-201	SA1881-001	SA1882-001	152682-201	152686-201
KE-430F	SB1173-001	SA6448-301				
BAS-311G	SA7575-101	SA3284-201	—	—	152682-201	152686-201
BAS-326G		S55215-001	—	—		
BAS-311F	S55217-201	S55215-001	—	—		
BAS-342G	SA8704-101	SA6448-301	—	—		

FOR JUKI/重机

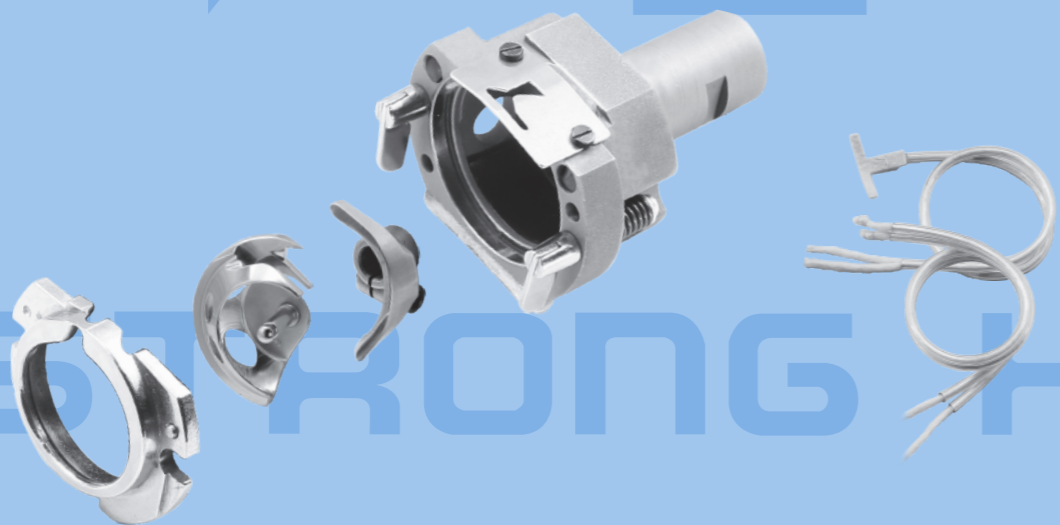

机型 Model	梭床组 Shuttle Race Assembly	梭托 Shuttle Driver	摆梭 Shuttle Hook			梭床盖 Shuttle Race Cover		
			薄料 Thin	中厚料 Medium	厚料 Heavy	薄料 Thin	中厚料 Medium	厚料 Heavy
LK-1900	141-03055	B1812-980-0A0	—	B1818-280-000	—	141-03253	141-03352	141-03659
LK-1900A	400-06573	400-11512	400-06580	400-06581	—			
AMS-210D	B1814-210-DA0	B1812-210-D00	—	—	—	—	B1817-210-DAB	—
AMS-210E	400-32671	400-14963	—	—	—	—	141-03352	—
New MOL-254	—	400-62404	—	—	—	—	—	—

We always bringing you the BEST



Guage set for industrial sewing machines 工业缝纫机针位组

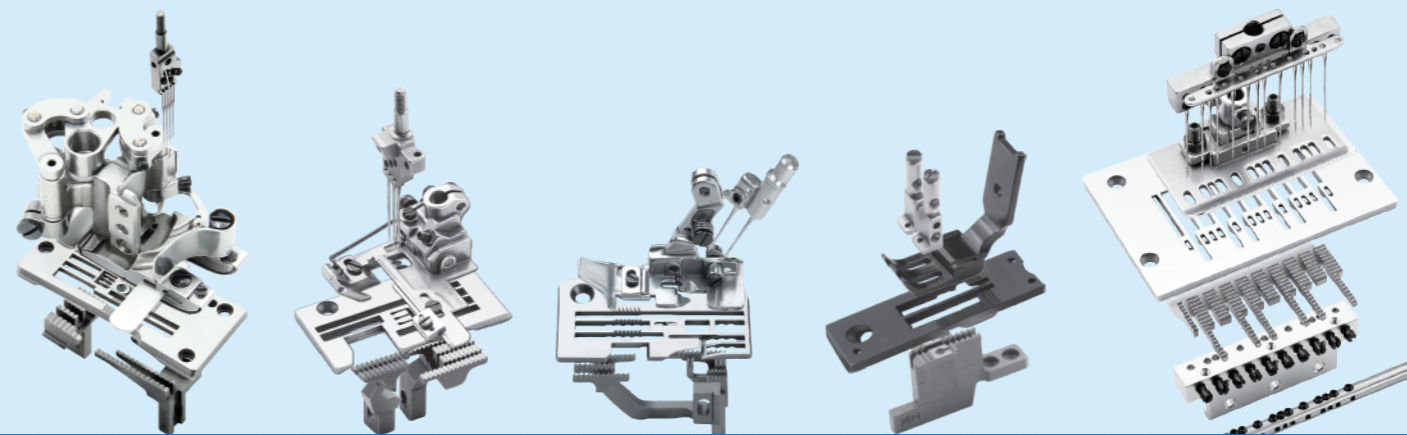

2025-2026

Industrial sewing machine spare components
工业缝纫机零配件部分



强信机械科技
STRONG H MACHINERY TECHNOLOGY

We always bringing you the BEST



Guage set

for industrial sewing machines
工业缝纫机针位组

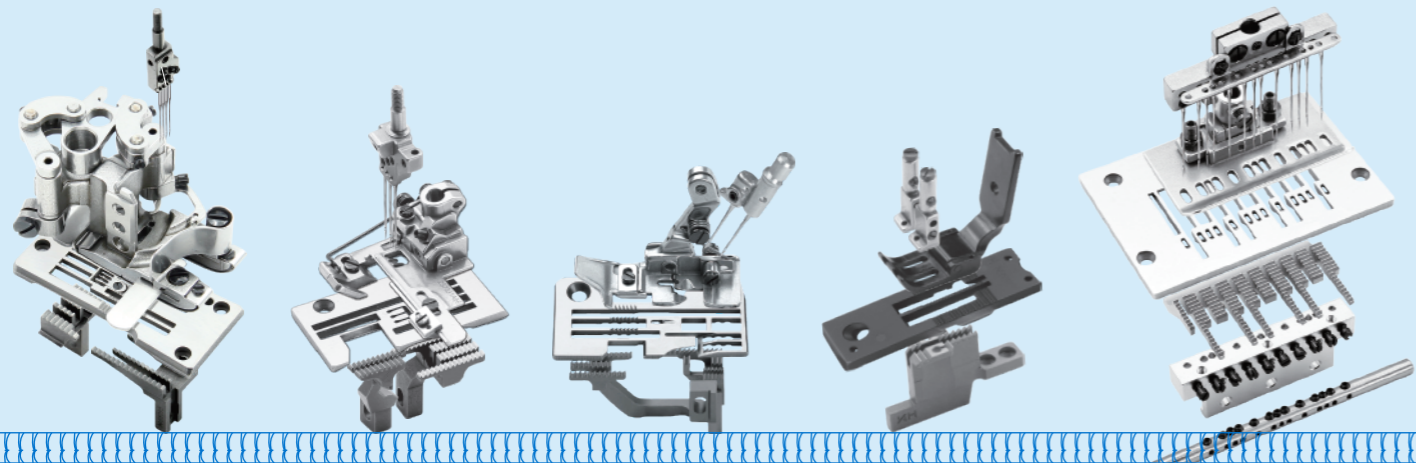

2025-2026

Industrial sewing machine spare components
工业缝纫机零配件部分



强信机械科技
STRONG H MACHINERY TECHNOLOGY

工业缝纫机针位组
GAUGE SET FOR INDUSTRIAL SEWING MACHINES
INDUSTRIAL SEWING MACHINES SPARE PARTS















FOR BROTHER/兄弟

LT2-B842				
-1		-3		-5
1/8	3/16 1/4	1/16 1/8	1/8	5/32
1-1 114950-001	1-2 112603-001 112604-001	1-3 142111-001 114950-001	 117369-001	1-4 150850-001
2-1 S07880-001	2-2 S07878-001 S07879-001	2-3 151078-001 114951-001	 114951-001	2-4 116509-001
3-1 114948-001	3-2 112638-001 112642-001	3-3 151076-001 114948-001	 114948-001	3-4 116502-001
4-1 158794-101	4-2 158791-101 158792-101	4-3 158808-001 158794-101	 158794-101	4-4 158796-101















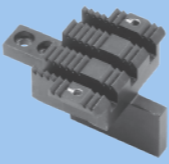



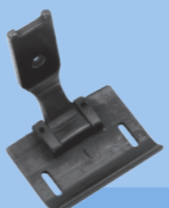

FOR BROTHER/兄弟

LT2-B842				
-3	-5		-3	-5
3/16 1/4	3/16 1/4	5/16 3/8	7/16 1/2 5/8	1/2 5/8
1-1  112603-001 112604-001	1-2  117133-001 117367-001		1-3  151596-001 116505-001 116507-001	S09365-001 159577-001
2-1  112659-001 112660-001	2-2  112661-001 116510-101		2-3  151598-001 116511-001 116512-001	116511-001 116512-001
3-1  112638-001 112642-001	3-2  112645-001 116498-001	3-3  151597-101 116499-101 116500-101		
4-1  158791-101 158792-101	4-2  158793-101 158798-101	4-3  158809-101 158797-101 158795-101		



FOR BROTHER/兄弟

LT2-B842				LT2-B845
-3	-7	-7	-7	-1
1 1 1/4 1 1/2	3/8	1/2 5/8	1	1/8
1-1  147176-001 116504-001 118945-001	1-2  144881-101	1-3  S09365-001 159577-001	1-4  147176-001	1-5  117369-001
2-1  147178-001 116508-001 118947-001	2-2  153887-001	2-3  153892-001 153897-001	2-4  153907-001	2-5  S07880-001
3-1  147177-101 116501-101 118946-101	3-2  116498-001	3-3  116499-101 116500-101	3-4  147177-101	3-5  114948-001
4-1  158805-101 158799-101 158800-101	4-2  158798-101	4-3  158797-101 158795-101	4-4  158805-101	4-5  S15711-001 5-1  S15712-001



FOR BROTHER/兄弟

LT2-B845				
-1	-3/-5	-7	-5	-3/-5
3/16 1/4	1/8	1/8	5/32	3/16 1/4
1-1 117133-001 117367-001	1-2 117369-001	1-3 150850-001	1-4 117133-001 117367-001	
2-1 S07878-001 S07879-001	2-2 114951-001	2-3 158430-001	2-4 116509-001	2-5 112659-001 112660-001
3-1 112638-001 112642-001	3-2 114948-001	3-3 116502-001	3-4 112638-001 112642-001	
4-1 S15723-001 S15735-001	4-2 S15711-001	4-3 S15717-001	4-4 S15723-001 S15735-001	
5-1 S15724-001 S15736-001	5-2 S15712-001	5-3 S15718-001	5-4 S15724-001 S15736-001	















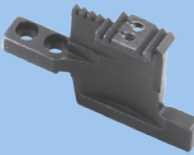







FOR BROTHER/兄弟

LT2-B845				
-7	-3/-5	-7	-3/-5	-7
3/16 1/4	5/16 3/8 7/16	3/8	1/2 5/8 3/4	1/2 5/8
1-1 117133-001 117367-001	1-2 144882-001 144881-101 144881-101 151596-001	1-3 S09365-001 159577-001 159577-001A S09365-001 159577-001		
2-1 S13588-001 153882-001	2-2 112661-001 116510-101 151598-001	2-3 153887-001 116511-001 116512-001 116512-001A 153892-001 153897-001		
3-1 112638-001 112642-001	3-2 112645-001 116498-001 151597-101	3-3 116498-001 116499-101 116500-101 116500-001A 116499-101 116500-101		
4-1 S15723-001 S15735-001	4-2 S15747-001 S15753-001 S15759-001	4-3 S15753-001 S15765-001 S15771-001 S32122-001 S15765-001 S15771-001		
5-1 S15724-001 S15736-001	5-2 S15748-001 S15754-001 S15760-001	5-3 S15754-001 S15766-001 S15772-001 S32123-001 S15766-001 S15772-001		

























FOR BROTHER/兄弟

LT2-B845				
-5-UT				
1/8	3/16 1/4 5/16	3/8	1/2 5/8	
1-1  155722-001	1-2  155851-001 155853-001 155855-001	1-3  155857-001	1-4  149677-001 149954-001	
2-1  148699-001	2-2  148703-001 148705-001 149691-001	2-3  149938-001	2-4  149675-001 149948-001	
3-1  148681-001	3-2  148691-001 148695-001 149687-001	3-3  S36566-001	3-4  149940-001	3-5  149671-101 149950-101
4-1  S15711-001	4-2  S15723-001 S15735-001 S15747-001	4-3  S15753-001	4-4  S15765-001 S15771-001	
5-1  S15712-001	5-2  S15724-001 S15736-001 S15748-001	5-3  S15754-001	5-4  S15766-001 S15772-001	





FOR BROTHER/兄弟

LT2-B872			LT2-B875	
-3/-5			-3/-5	
1/8	3/16 1/4	3/8 1/2 5/8	1/8	3/16 1/4 5/16
1-1  117369-001	1-2  117133-001 117367-001	1-3  144881-101 S09365-001 159577-001	1-4  117369-001	1-5  117133-001 117367-001 144882-001
2-1  158430-001	2-2  S13588-001 153882-001	2-3  153887-001 153892-001 153897-001	2-4  114951-001	2-5  112659-001 112660-001 112661-001
3-1  155463-001	3-2  155457-001 155453-001	3-3  155461-001 S09367-101 159575-101	3-4  155463-001	3-5  155457-001 155453-001 155459-001
4-1  158794-101	4-2  158791-101 158792-101	4-3  158798-101 158797-101 158795-101	4-4  S15711-001	4-5  S15723-001 S15735-001 S15747-001
			5-1  S15712-001	5-2  S15724-001 S15736-001 S15748-001



FOR BROTHER/兄弟



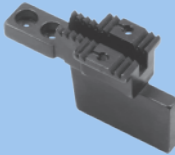
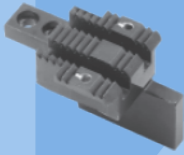













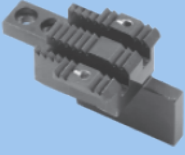



LT2-B875

-3/-5		-7		
3/8	1/2 5/8	1/8	3/16 1/4	3/8 1/2 5/8
1-1  144881-101	1-2  S09365-001 159577-001	1-3  117369-001	1-4  117133-001 117367-001	1-5  144881-101 S09365-001 159577-001
2-1  116510-101	2-2  116511-001 116512-001	2-3  158430-001	2-4  S13588-001 153882-001	2-5  153887-001 153892-001 153897-001
3-1  155461-001	3-2  S09367-101 159575-101	3-3  155463-001	3-4  155457-001 155453-001	3-5  155461-001 S09367-101 159575-001
4-1  S15753-001	4-2  S15765-001 S15771-001	4-3  S15711-001	4-4  S15723-001 S15735-001	4-5  S15753-001 S15765-001 S15771-001
5-1  S15754-001	5-2  S15766-001 S15772-001	5-3  S15712-001	5-4  S15724-001 S15736-001	5-5  S15754-001 S15766-001 S15772-001



FOR BROTHER/兄弟

LT2-B875

-5-UT			
1/8	3/16 1/4 5/16	3/8	1/2 5/8
1-1  155722-001	1-2  155851-001 155853-001 155855-001	1-3  155857-001	1-4  149677-001 149954-001
2-1  148699-001	2-2  148703-001 148705-001 149691-001	2-3  149938-001	2-4  149675-001 149948-001
3-1  155463-001	3-2  S36562-001	3-3  155457-001 155453-001 155459-001	3-4  S36564-001 S36566-001
	3-5  155461-001	3-6  S09367-101 159575-101	
4-1  S15711-001	4-2  S15723-001 S15735-001 S15747-001	4-3  S15753-001	4-4  S15765-001 S15771-001
5-1  S15712-001	5-2  S15724-001 S15736-001 S15748-001	5-3  S15754-001	5-4  S15766-001 S15772-001













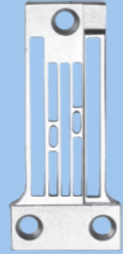







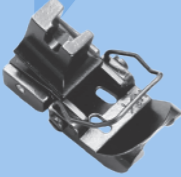
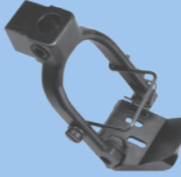

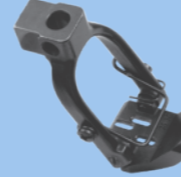
工业缝纫机针位组

GAUGE SET FOR INDUSTRIAL SEWING MACHINES

INDUSTRIAL SEWING MACHINES SPARE PARTS

FOR BROTHER/兄弟

DT6-B927-8 4.8(3/16)	DT6-B927 6.4(1/4)	DT6-B928 6.4(1/4)	DT6-B928-7 3.2×3(1/8×3)	DT6-B928-6 3.2×3(1/8×3)
薄料、中厚料 Thin materials Medium materials	中厚料 Medium materials	特厚料 Extra heavy materials	厚料 Heavy materials	特厚料 Extra heavy materials
1-1  S05946-101	1-2  S11508-101	1-3  150666-001	1-4  148864-001	1-5  150667-001
2-1  S40369-001	2-2  S40370-001	2-3  150673-001	2-4  148867-101	2-5  150675-101
3-1  S40355-101	3-2  106160-101	3-3  150668-101	3-4  148865-201	3-5  150672-101
4-1  183954-001	4-2  183978-001	4-3  181716-001		
5-1  S06310-001	5-2  148973-001	5-3  148875-001		
6-1  148876-001-0	1:111443003 2:062671012 3:021670102 4:148876-001			

















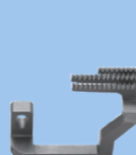



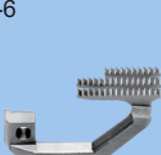
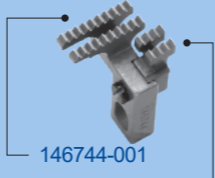

工业缝纫机针位组

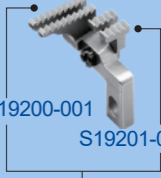
GAUGE SET FOR INDUSTRIAL SEWING MACHINES



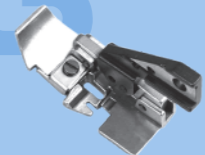











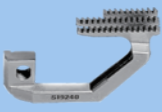



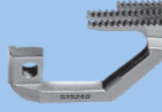

INDUSTRIAL SEWING MACHINES SPARE PARTS

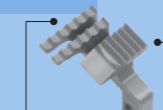















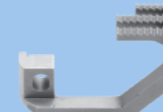
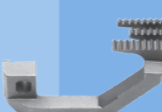

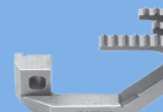
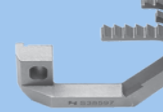

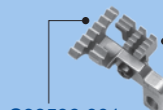

FOR BROTHER/兄弟

EF4-B511-01	EF4-B531	MA4-B551			EF4-N11		
0×3 0×5	0×4 0×6	5(2.2×5) 5(2.2×6)	6(2.2×5) 6(2.2×6)	063 (3×3) 064 (3×4)	065(5×5)	087(5×5) 092(5×5)	01-4 01-5
1-1  146730-001 146731-001 146732-001 146733-001	1-2  146781-001 146782-001	1-3  146501-001 146502-001	1-4  146504-001	1-5  146510-001	1-6  S19145-001 S19146-001		
2-1  146748-001	2-2  156036-001	2-3  146572-001	2-4  146573-001	2-5  146574-001	2-6  S19236-001		
3-1  146744-001 146577-001	3-2  146567-001 146577-001	3-3  146568-001 146577-001	3-4  146569-001 146577-001	3-5  S19200-001 S19201-001 S19199-001			
4-1  146884-001	4-2  146902-001	4-3  146871-101	4-4  146874-001	4-5  148013-101	4-6  S20494-001 S19260-001		
5-1  146773-001	5-2  146489-001	5-3  146491-001					

FOR BROTHER/兄弟











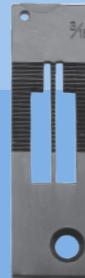

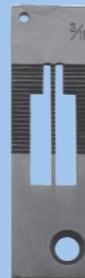

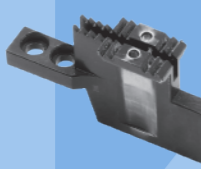
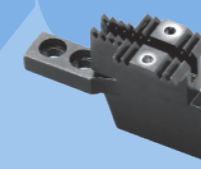

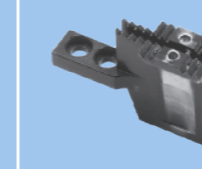
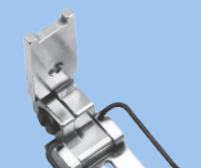
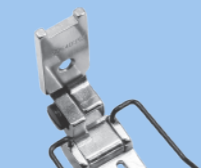
EF4-N11			EF4-N21		
01-4(B)(0×4) 01-5(B)(0×5)	01-5(C)(0×5)	07-2	22-4(2.2×4) 22-5(2.2×5)	27-5(2.2×5)	41-5(2.2×5)
1-1  S19154-001	1-2  S19155-001	1-3  S19153-001	1-4  S25190-001 S19162-001	1-4  S19166-001	
2-1  S19240-001	2-2  S25574-001	2-3  S19240-001	2-4  S19237-101	2-5  S19240-001	
3-1  S19213-001 S19204-001 S19212-001	3-2  S19206-001 S19211-001 S19210-001	3-3  S19213-001 S19201-001 S19217-001	3-4  S19955-001 S19204-001 S19202-001	3-5  S19213-001 S19204-001 S19212-001	
4-1  S20494-001 S19260-001	4-2  S20494-001 S29948-001	4-3  S20494-001 S19271-001	4-4  S20494-001 S25543-001	4-5  S20494-001 S19287-201	4-6  S20494-001 S19293-001
5-1  146491-001			5-2  S20398-001		

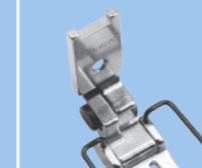
FOR BROTHER/兄弟

EF4-N21	MA4-N31		MA4-N31 FB-N310	
45-5(2.2×5)	63-3(3×3) 63-4(3×4)	63-5(3×5) 63-7(3×7)	65-5(5×5) 65-6(5×6)	92-5 92-6 92-7
1-1  S19169-001	1-2  S20234-001 S20235-001 S20236-001 S25196-001	1-3  S20232-001 S20233-001	1-4  S19185-001 S19186-001 S19187-001	
2-1  S19244-101	2-2  S20245-001	2-3  S20244-001	2-4  S19247-001	2-5  S38597-001
3-1  S19202-001 S19204-001 S19219-001	3-2  S20242-001 S20243-001 S20241-101	3-3  S20240-001 S19223-101 S20239-101	3-4  S19229-001 S19223-101 S19228-101	3-5  S38596-001 S19223-101 S38595-001
4-1  S20494-001 S19297-001	4-2  S19313-201	4-3  S19317-101 S19318-101	4-4  S19334-001	4-5  S30525-001
5-1  S20398-001	5-2  S20404-001	5-3  S20406-001	5-4  S21104-001	











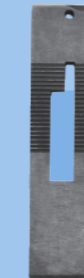



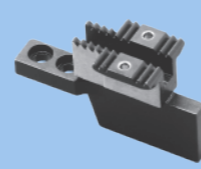
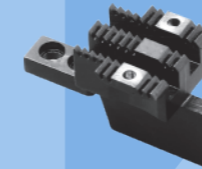
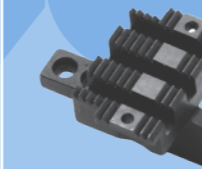
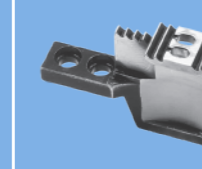
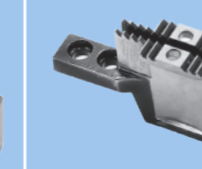
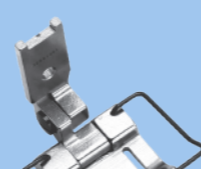



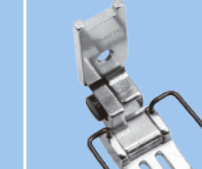

FOR JUKI/重机

















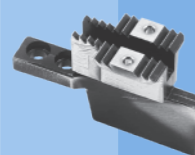

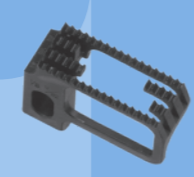
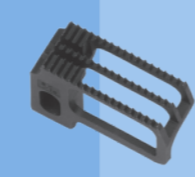
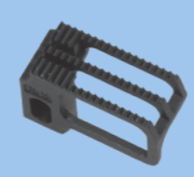



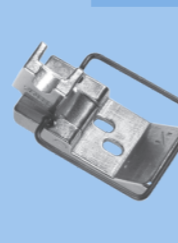



LH-3528A-7			LH-3568A-7	
1/8 5/32	3/16 1/4	5/16 3/8	1/8 5/32	3/16 1/4 5/16
1-1  400-35881 400-25485	1-2  400-25490 400-25492	1-3  400-25494 400-25495	1-4  400-35881 400-25485	1-5  400-25490 400-25492 400-25494
2-1  400-61270 400-61271	2-2  400-61272 400-61274	2-3  400-61276 400-61277	2-4  400-61270 400-61271	2-5  400-61272 400-61274 400-61276
3-1  400-35896 400-35897	3-2  228-16577 228-16755	3-3  228-16953 226-40957	3-4  400-35896 400-35897	3-5  226-40353 226-40551 226-40858
4-1  400-26027 400-26029	4-2  400-26031 400-26035	4-3  400-26039 400-26041	4-4  B1402-528-BA0-A B1402-528-CA0-A	4-5  B1402-528-DAL-A B1402-528-FAL-A B1402-528-HAL-A
			5-1  B1402-528-BA0-A B1402-528-CA0-A	5-2  B1402-528-DAR-A B1402-528-FAR-A B1402-528-HAR-A



















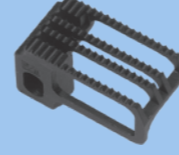
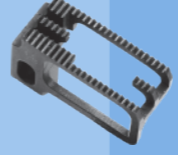
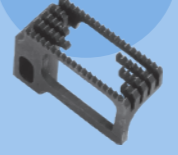

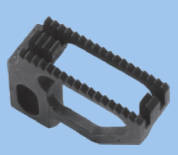
FOR JUKI/重机

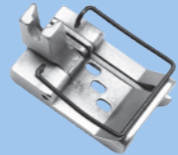
LH-3568A-7			LH-3588A-7	
3/8 1/2	5/8 3/4	7/8 1	1/8 5/32	3/16 1/4 5/16
1-1  400-25495 400-25498	1-2  400-25499 400-25500	1-3  400-25502 400-25503	1-4  400-35881 400-25485	1-5  400-25090 400-25492 400-25494
2-1  400-61277 400-61278	2-2  400-61289 400-61280	2-3  400-71913 400-71914	2-4  400-53705 400-71911	2-5  400-35891 400-35892 400-50011
3-1  226-40957 226-41252	3-2  226-41351 226-41450	3-3  400-33949 400-33951	3-4  400-35896 400-71909	3-5  228-16557 228-16755 228-16953
4-1  B1402-528-KAL-A B1402-528-LAL	4-2  B1402-528-MAL B1402-528-NAL	4-3  B1402-528-PAL B1402-528-QAL	4-4  B1402-528-BA0-A B1402-528-CA0-A	4-5  B1402-528-DAL-A B1402-528-FAL-A B1402-528-HAL-A
5-1  B1402-528-KAR-A B1402-528-LAR	5-2  B1402-528-MAR B1402-528-NAR	5-3  B1402-528-PAR B1402-528-QAR	5-4  B1402-528-BA0-A B1402-528-CA0-A	5-5  B1402-528-DAR-A B1402-528-FAR-A B1402-528-HAR-A

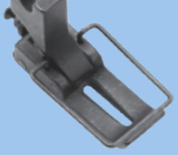











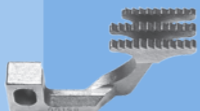

FOR JUKI/重机

LH-3588A-7		MH-481	MH-380		
3/8 1/2	5/8 3/4	1×0	2×1/8 2×5/32	2×3/16 2×7/32	2×1/4 2×5/16
1-1  400-25495 400-25498	1-2  400-25499 400-25500	1-3  B1103-481-F00	1-4  B1103-380-B00 B1103-380-C00	1-5  B1103-380-D00 B1103-380-E00	1-6  B1103-380-F00 B1103-380-H00
2-1  400-35893 400-35894	2-2  400-71912 400-35895	2-3  B1613-481-F00	2-4  B1613-380-B00 B1613-380-C00	2-5  B1613-380-D00 B1613-380-E00	2-6  B1613-380-F00 B1613-380-H00
3-1  228-17050 228-17159	3-2  400-33945 400-33947	3-3  B1524-481-0B0	3-4  B1509-038-BB0 B1509-038-CB0	3-5  B1509-038-DB0 B1509-038-EB0	3-6  B1509-038-FB0 B1509-038-HB0
4-1  B1402-528-KAL-A B1402-528-LAL	4-2  B1402-528-MAL B1402-528-NAL	4-3 	4-4 	4-5 	4-6 
5-1  B1402-528-KAR-A B1402-528-LAR	5-2  B1402-528-MAR B1402-528-NAR		4-4  B1406-019-BA0 B1406-019-CA0	4-5  B1406-019-DA0 B1406-019-EA0	4-6  B1406-019-FA0 B1406-019-HA0

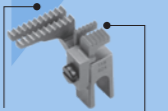
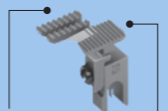
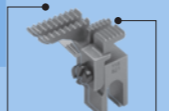
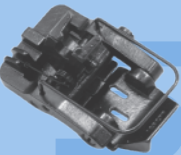

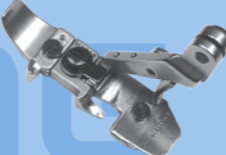









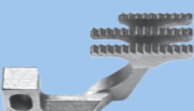
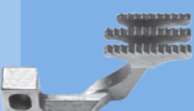
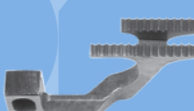

FOR JUKI/重机

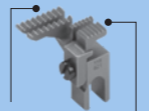
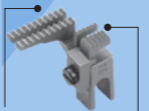
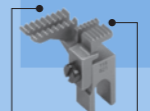
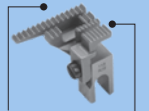
MH-380				MH-382	
2×3/8 2×1/2	3×1/8*1/8 3×3/16 3×1/4	3×1/4F.A	3×1/8F-PL	3×1/4	2×1/4
1-1  B1103-380-K00 B1103-380-L00	1-2  NE388 NE387	1-3  12605004	1-4  12615006	1-5  NE389	1-6  B1103-382-000
2-1  B1613-380-K00 B1613-380-L00	2-2  FE247 FE246	2-3  12614004	2-4  FE248	2-5  B1613-382-000	
3-1  B1509-038-KB0 B1509-038-LBB	3-2  PE227 PE226	3-3  1261601000	3-4  PE228	3-5  B1524-382-0B0	
4-1  B1406-019-KA0 B1406-019-LA0	4-2  TE3059 TE3058	4-3  12634004	4-4  TE3060	4-5  D1406-038-BA0	

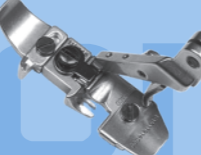













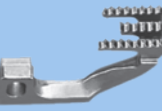

FOR JUKI/重机

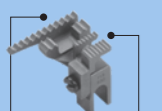
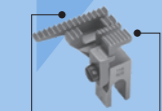
MS-1190	MO-2414N	MO-2504		
3/16	BE6(2×4)	OA4-150 OA4-150-FG (0×1.6)	OD4 OD4-FG(0×3.2) OE4-300(0×4.0)	OD4-200(0×3.2)
1-1  129-23405	1-2  R4305-HOE-E00	1-3  R4200-HOA-C00	1-4  R4200-HOE-D00	1-5  R4200-HOD-D00
2-1  129-32307	2-2  118-86504	2-3  B1657-804-00T		
	3-1  118-82404 118-87106	3-2  118-82107 118-87007	3-3  118-82107 118-87106	
4-1  129-27760	4-2  118-76851	4-3  118-76059	4-4  118-76158	4-5  118-81455
5-1  129-25954	5-2  118-69658	5-3  118-69005		



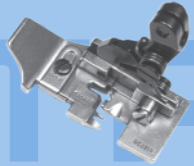











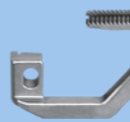
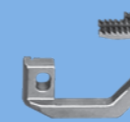
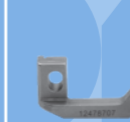

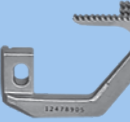
FOR JUKI/重机

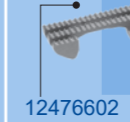
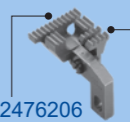
MO-2504	MO-2514		MO-2516	
OD6-300 (0×3.2)	BO6-340 (2×3.2)	BD4-200 BD4-200-FG	BD4(2.0×3.2) BD4-FG	DD4-300(3.2×3.2) DF4-300(3.2×4.8)
1-1  R4300-HOD-E00	1-2  R4305-HOD-E00	1-3  R4205-HOD-E00	1-4  R4205-HOD-EA0	1-5  R4508-HOD-D00 R4508-HOF-D00
2-1  118-85100	2-2  118-86504	2-3  B1657-814-B0E		2-4  118-85209
3-1  118-82206 118-87106	3-2  118-82404 118-87106	3-3  115-97101 118-87106		3-4  118-82800 118-87403
4-1  118-76356	4-2  118-79251	4-3  118-81554	4-4  118-76851	4-5  118-77552
5-1  118-69005	5-2  118-69658		5-3  118-70359	

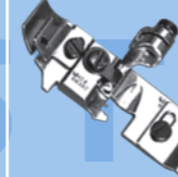

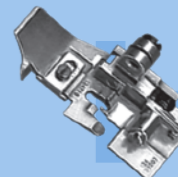













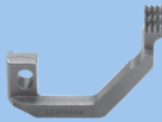
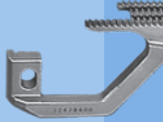

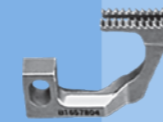
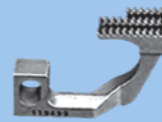

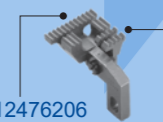

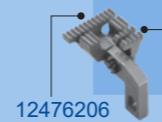
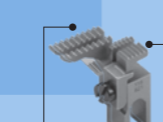
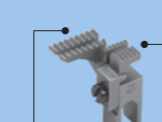



FOR JUKI/重机

MO-2516	MO-2543	MO-3304E		
FF6-500 (4.8×4.8)	FBD6-300 FBD6-300-FG (4.8×2.0×3.2)	OE4-40H (0×3.6)	OF6-50H (0×4.8)	DE-40H/Z192 (0×3.1)
1-1  R4612-HOF-G00	1-2  R4612-HOD-E01	1-3  R4200-LOE-E00	1-4  R4300-LOF-E00	1-5  R4200-L2E-E00
2-1  118-85407	2-2  118-86009	2-3  124-78004	2-4  124-78806	2-5  124-79101
3-1  118-83006 118-87304	3-2  118-84004 118-87403	3-3  12476008 12480000 12478004 124760A6 12476008 12480000	3-4  12476701 12480109 12478806 124767A9 12476701 12480109	3-5  12476800 12480000 12479101 124768A8 12476800 12480000
4-1  118-77750	4-2  118-78055	4-3  124-66058		
5-1  118-70458	5-2  118-70854	5-3  124-65001		













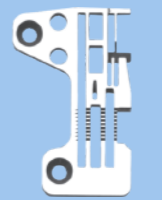



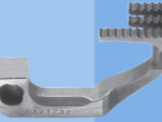

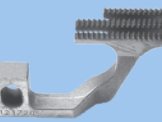
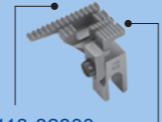







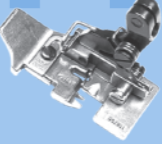

FOR JUKI/重机

MO-3305E	MO-3314E		MO-3316E	
OE4-41H/L121 (0×3.4)	BE6-44H/G41/Q148 (2.2×3.6) BE6-40H(2.2×3.6)	BE6-42H/S170 (2.2×3.6)	DE4-40H (3×3.8)	DE6-40H (3×3.8)
1-1  R4200-LOE-D00	1-2  R4305-LOE-E00	1-3  R4305-LOE-E0A	1-4  R4508-LOE-G00	1-5  R4608-LOE-G00
2-1  124-78301	2-2  124-78103	2-3  124-78707	2-4  124-78202	2-5  124-78905
3-1  12476305 12480307 12478301 124763A3 12476305 12480307	3-2  12476107 12480109 12478103 124761A5 12476107 12480109	3-3  12476602 12480109 12478707 124766A0 12476602 12480109	3-4  12476206 12480208 12478202 124762A4 12476206 12480208	
4-1  12466157	4-2  12466850	4-3  12466553	4-4  12466751	4-5  12470050
5-1  124-65001	5-2  124-65100		5-3  124-65407	

















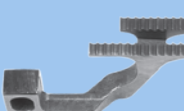





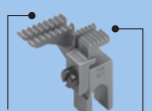
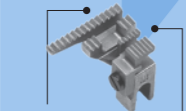
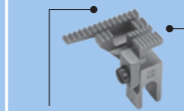
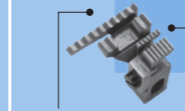
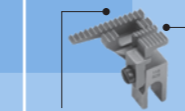



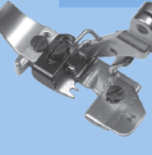
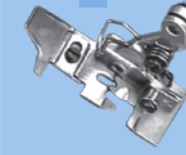

FOR JUKI/重机

MO-3316E			MO-3343	MO-3904	MO-3914
DE6-42H/S169 (3×3.8)	FF6-40H (4.8×4.8)	FF6-60H(4.8×4.8) FH6-60H(4.8×6) FH6-50H(4.8×6)	(4.8×2.2×3.2)	OE4(0×4.0) OE4-FG(0×4.0)	BE6(2.0×4.0) BE6-FG(2.0×4.0)
1-1  R4608-LOE-G0A	1-2  R4612-LOF-G00	1-3  R4612-LOF-L00 R4612-LOH-L00 R4612-LOH-G00	1-4  R4612-L0D-E01	1-5  R4200-JOE-D00	1-6  R4305-JOE-E00
2-1  124-78608	2-2  124-78400	2-3  124-78509	2-4  124-78905	2-5  B1657-804-OOT	2-6  119-49906
3-1  12476503 12480406 124765A1 12480406	3-2  12476206 12480208 124762C0 12480208	3-3  12476404 12480208 124764A2 12480208	3-4  12476206 12480208 124762B2 12480208	3-5  118-82107 118-87106	3-6  119-49807 118-87106
4-1  12470357	4-2  12470159	4-3  12470258	4-4  12473153	4-5  118-76158	4-6  121-52450
5-1  124-65407	5-2  124-65506	5-3  124-65605	5-4  118-76166	5-5  121-52468	6-1  121-48607
			6-2  121-48706		















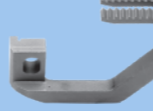
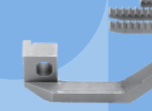
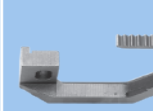

FOR JUKI/重机

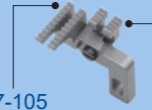
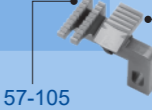
MO-3916			MO-3943	MO-6704	MO-6714
OE4(3.2×4.0) OE4-FG(3.2×4.0)	DE6(3.2×4.0)	FF6(4.8×4.8) FF6-FG(4.8×4.8)	FBD6-347/G07/Q141 (4.8×2×3.2)	OE4-40H (0×4.0)	BE6-20H (2×4.0)
1-1  R4508-JOE-D00	1-2  R4608-JOE-D00	1-3  R4612-JOF-D00	1-4  R4612-JOD-E01	1-5  R4200-J6E-D00	1-6  R4305-J6E-E00
2-1  121-72805	2-2  121-73209	2-3  121-73308	2-4  131-92802	2-5  121-72003	
3-1  118-82800 118-87403	3-2  118-82909 118-87106	3-3  118-84004 118-87403	3-4  131-91606 131-91309	3-5  121-71500 118-87106	
4-1  121-53755	4-2  121-54258	4-3  118-81257	4-4  118-76158	4-5  118-76851	
5-1  121-53763	5-2  121-54266	5-3  118-81265	5-4  118-76166	5-5  118-76869	
6-1  121-49803	6-2  121-50306	6-3  121-50603	6-4  121-48607	6-5  122-75509	

FOR JUKI/重机

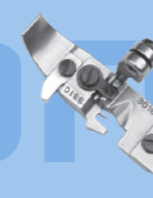
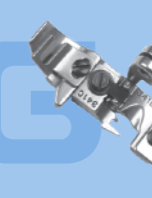











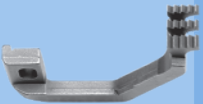
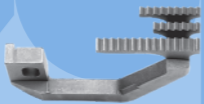
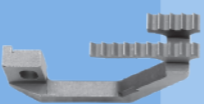

MO-6714	MO-6716			MO-6743	MO-814
BE4-40H (2×4.0)	DE6-40H (3.2×4.0)	FF6-40H (4.8×4.8)	FF6-60H	ID6-40H (4.8×2×3.2)	BD4(2.0×3.2)
1-1  R4205-J6E-E00	1-2  R4608-J6E-D00	1-3  R4612-J6F-D00	1-4  R4612-J6H-K00	1-5  R4612-J6D-E01	1-6  R4205-EOD-E00
2-1  B1657-814-B0E	2-2  121-73209	2-3  121-73308	2-4  121-74207	2-5  121-73308	2-6  B1657-804-00C
3-1  115-97101 118-87106	3-2  118-82909 118-87403	3-3  118-84004 118-87403	3-4  121-71104 118-87403	3-5  118-84004 118-87403	3-6  B1656-804-000 B1658-804-000
4-1  118-76851	4-2  121-53755	4-3  121-54258	4-4  121-55552	4-5  118-78055	4-6  B1507-814-0A0
5-1  118-76869	5-2  121-53763	5-3  121-54266	5-4  121-55560	5-5  118-78063	
6-1  122-75509		6-2  122-57507	6-3  121-50702	6-4  122-75004	6-5  B1420-714-B00

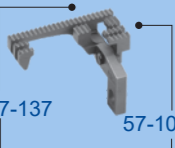
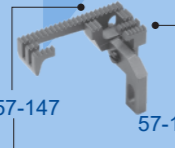
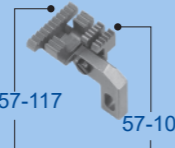
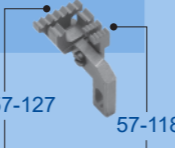
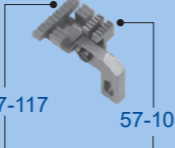
FOR KANSAI SPECIAL/关西

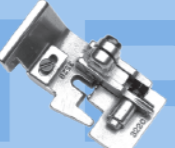
UK2004S-20F	UK2005S-10M	UK2004S-01M	UK2014H-01M	UK2014H-40M	UK2116S-01M UK2116S-02M
0×1.5	0×3 0×4	0×4	2×4 2×5	2×4 2×5	3×4 3×5
1-1  57-031	1-2  57-011 57-021	1-3  57-001	1-4  57-041 57-051	1-5  57-061 57-071	1-6  57-002
2-1  57-211	2-2  57-201	2-3  57-202			
3-1  57-115 57-126 57-1210-1	3-2  57-115 57-116 57-1110-1	3-3  57-105 57-106 57-1010-1	3-4  57-105 57-116 57-1310-1	3-5  57-107 57-108 57-1020-1	
4-1  57-3210-1	4-2  57-3110-1	4-3  57-3010-1	4-4  57-3310-1	4-5  57-3410-1	4-6  57-3020-1 57-3120-1
5-1  57-503	5-2  57-505	5-3  57-504			











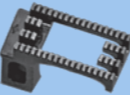





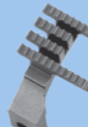

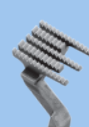

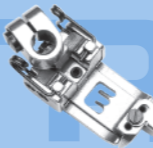
FOR KANSAI SPECIAL/关西

UK2116S-30M	UK2116S-30M	UK2116S-01H	UK2116H-03X	UK2143H-90M
3×4	5×5	5×5	5×5 5×6	3×2×4
1-1  57-042	1-2  57-012	1-3  57-022 57-032	1-4  57-052	
2-1  57-232	2-2  57-212	2-3  57-222	2-4  57-242	
3-1  57-137 57-108 57-1320-1	3-2  57-147 57-108 57-1420-1	3-3  57-117 57-108 57-1120-1	3-4  57-127 57-118 57-1220-1	3-5  57-117 57-108 57-1120-1
4-1  57-3420-1	4-2  57-3520-1	4-3  57-3220-1	4-4  57-3320-1	4-5  57-3620-1
5-1  57-504	5-2  57-506	5-3  57-507		



FOR KANSAI SPECIAL/关西

DVK1702B B2000	WX8700D WX8800D	RX9700D RX9800D	RX9700A RX9800A	WX8800DW	PX302-4W	LX5802M
(2×6.4)	(3×5.6) (3×6.4)	(3×5.6) (3×6.4)	(3×5.6) (3×6.4)	(1/4×3N)		2×6.4
1-1  14-763	1-2  14-890 14-891	1-3  14-880	1-4  14-3310 14-3320 14-3330 14-3010	1-5  14-563		
2-1  15-704	2-2  15-805 15-807	2-3  15-855 15-857	2-4  15-870	2-5  15-361	2-6  15-536	
	3-1  15-843 15-844	3-2  15-856 15-858	3-3  15-875	3-4  15-301	3-5  15-535	
4-1  17-7620-1	4-2  17-7680-1 17-7690-1	4-3  17-7690-1	4-4  17-3610-1	4-5  17-5630-1		
5-1  12-2290-1	5-2  12-8380-1 12-8390-1	5-3  12-8180-1 12-8190-1	5-4  12-8190-1	5-5  12-3150-1		



工业缝纫机针位组

GAUGE SET FOR INDUSTRIAL SEWING MACHINES

INDUSTRIAL SEWING MACHINES SPARE PARTS

FOR KANSAI SPECIAL/关西

DVK1702D V7002D	DWK1802D W8002D	DVK1703D/V7003D DVK1803D/W8003D	DVK1702DE V7002DE	DWK1802DE W8002DE	DVK1703DE/V7003DE DVK1803E/W8003DE
1/8"(2×3.2) 5/32"(2×3.2)	3/16"(2×4.8) 7/32"(2×5.6) 1/4"(2×6.4)	7/32"(3×5.6) 1/4"(3×6.4)	1/8"(2×3.2) 5/32"(2×4.0)	3/16"(2×4.8) 7/32"(2×5.6) 1/4"(2×6.4)	7/32"(3×5.6) 1/4"(3×6.4)
1-1 14-724 14-734	1-2 14-744 14-754 14-764	1-2 14-854 14-864	1-3 14-725 14-735	1-3 14-745 14-755 14-765	1-4 14-855 14-865
2-1 15-724		15-723 15-723		15-724 15-724	
3-1 15-755		15-753 15-753		15-755 15-755	
DVK1702F DVK1802F V7002F		DVK1703F DVK1803F V7003F		WX8802F	
1/8"(2×3.2) 5/32"(2×4.0)	3/16"(2×4.8) 7/32"(2×5.6) 1/4"(2×6.4)	7/32"(3×5.6) 1/4"(3×6.4)	1/8"(2×3.2) 5/32"(2×4.0)	3/16"(2×4.8) 7/32"(2×5.6) 1/4"(2×6.4)	7/32"(3×5.6) 1/4"(3×6.4)
4-1 14-726 14-736	4-2 14-746 14-756 14-766	4-3 14-856 14-866	4-4 14-726 14-736	4-5 14-746 14-756 14-766	4-6 14-856 14-866
5-1 15-729	5-2 15-726 (15-727)	5-3 15-813	5-4 15-811		
6-1 15-758	6-2 15-756	6-3 15-814	6-4 15-812		

工业缝纫机针位组

GAUGE SET FOR INDUSTRIAL SEWING MACHINES











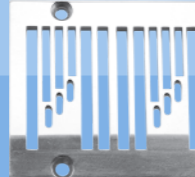

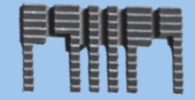
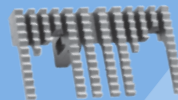
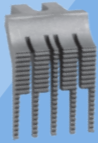

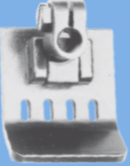

INDUSTRIAL SEWING MACHINES SPARE PARTS











FOR KANSAI SPECIAL/关西

WX8802D	WX8803C	WX8703D WX8803D	DVK1702E	DVK1703E	1503PHD
2×3.2 2×4.0 2×4.8	7/32"(3×5.6) 1/4"(3×6.4)	7/32"(3×5.6) 1/4"(3×6.4)	3/16"(2×4.8) 7/32"(2×5.6) 1/4"(2×6.4)	7/32"(3×5.6) 1/4"(3×6.4)	1/4
1-1 14-806 14-807 14-808	1-2 14-860 14-862	1-3 14-820 14-819	1-4 14-745 14-755 14-765	1-5 14-855 14-865	1-6 14-553
2-1 15-805	2-2 15-823	2-3 15-807	2-4 15-704	2-5 15-553	
3-1 15-806	3-2 15-808				

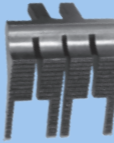
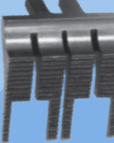
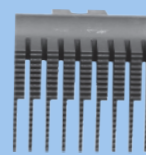
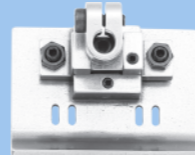
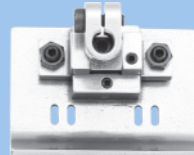
FOR KANSAI SPECIAL/关西

DLR 1508P-E	DLR 1509P-E	1404P	
4×1/4*1*1/4	6×1/8*1/8*1*1/8*1*8	4×1 4×5/32 4×3/4	4×1-1/8 4×1-1/2
1-1  14-581	1-2  14-591	1-3  14-421 NE373 14-4180-0	1-4  14-422 14-424
2-1  15-581	2-2  15-591	2-3  15-421 FE244 15-4180-0	2-4  15-422 15-424
3-1  17-5810-1	3-2  17-5760-1	3-3  17-3710-1 PE224 17-3750-1	3-4  17-3720-1 17-3740-1
4-1  12-5810-1	4-2  12-591	4-3  12-4210-1 TE2989 12-4180-1	4-4  12-4220-1 12-4240-1
		5-1  19-4210-1 TE2991 19-4180-1	5-2  19-4220-1 19-4240-1
		6-1  18-4210-1 TE2990 18-4180-1	6-2  18-4220-1 18-4240-1

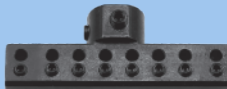
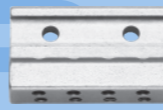
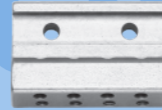
FOR KANSAI SPECIAL/关西

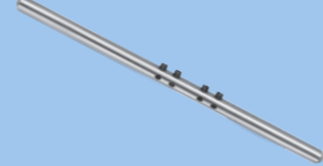
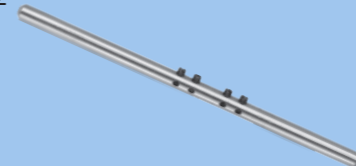
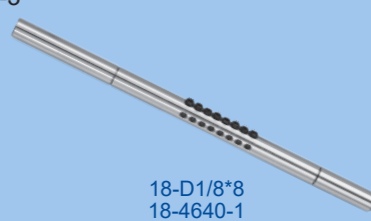
1404P				
4×3/16*5/8*3/16 4×3/16*3/4*3/16	4×3/16*7/8*3/16 4×3/16*1*3/16	4×1/4*3/8*1/4 4×1/4*1/2*1/4 4×1/4*5/8*1/4	4×1/4*3/4*1/4 4×1/4*7/8*1/4 4×1/4*1*1/4	8×1/8 8×3/16
1-1  14-437 14-426	1-2  NE333 14-428 14-429	1-3  14-427 14-4301 14-431		
2-1  15-437 15-426	2-2  FE224 15-428 15-429	2-3  15-427 15-4301 15-431		
3-1  PE214 17-3760-1	3-2  PE211 17-4280-1 PE212	3-3  17-3770-1 PE213 17-3810-1		
4-1  12-4370-1 12-4260-1	4-2  TE2905 12-4280-1 12-4380-1	4-3  12-4270-1 12-4301-1 12-4290-1		
5-1  19-4320-1 19-4260-1	5-2  TE2907 19-4280-1 19-4380-1	5-3  19-4270-1 19-4301-1 19-4290-1		
6-1  18-4370-1 18-4260-1	6-2  TE2096 18-4280-1 18-4290-1	6-3  18-4270-1 18-4301-1 18-4310-1		



FOR KANSAI SPECIAL/关西

1412P		1412PSSM
1-1 11×1/8T 14-D1/8*11T	1-2 12×1/8 12×3/16 12×1/4 14-480 14-497 14-496	1-3 12×3/16 12×1/4 14-028 14-029
2-1 15-11T	2-2 15-480 15-497 15-496	2-3 15-046 15-047
3-1 17-11T	3-2 17-4780-1 17-3970-1 17-3960-1	3-3 17-0460-1 17-0470-1
4-1 12-11T	4-2 12-4780-1 12-4990-1 12-4980-1	12-4990-1 12-4980-1
5-1 19-11T	5-2 19-4140-1 19-4970-1 19-4960-1	19-4970-1 19-4960-1
6-1 18-11T	6-2 18-4800-1 18-4970-1 18-4960-1	18-4970-1 18-4960-1





FOR KANSAI SPECIAL/关西

1412P		
1-1 13×3/16 14-D3/16*13	1-2 15×1/8T 14-D1/8*15T	1-3 15×3/16 14-D3/16*15
2-1 15-D3/16*13	2-2 15-D1/8*15T	2-3 15-D3/16*15
3-1 17-D3/16*13	3-2 17-D1/8*15T	3-3 17-D3/16*15
4-1 12-D3/16*13	4-2 12-D1/8*15T	4-3 12-D3/16*15
5-1 19-D3/16*13	5-2 19-D1/8*15T	5-3 19-D3/16*15
6-1 18-D3/16*13	6-2 18-D1/8*15T	6-3 18-D3/16*15



FOR KANSAI SPECIAL/关西

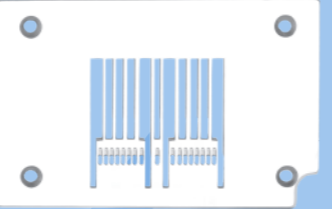
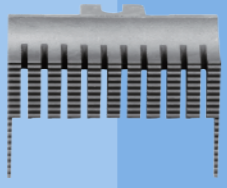
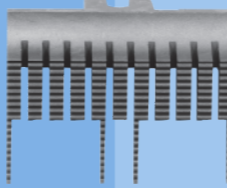
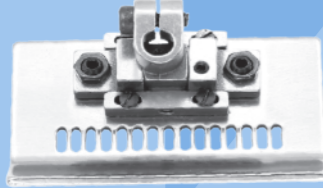
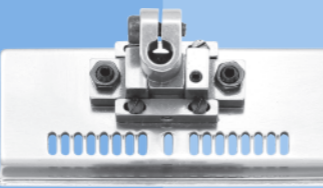
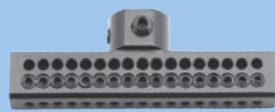
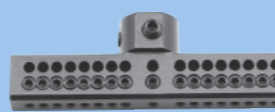

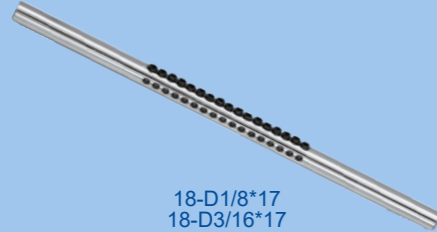
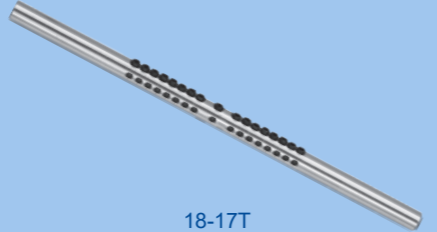

1412P

<p>17×1/8 17×3/16</p> <p>1-1</p>  <p>14-D1/8*17 14-D3/16*17</p>	<p>17×1/8T</p> <p>1-2</p>  <p>14-17T</p>
<p>2-1</p>  <p>15-D1/8*17 15-D3/16*17</p>	<p>2-2</p>  <p>15-17T.A</p>
<p>3-1</p>  <p>17-D1/8*17 17-D3/16*17</p>	<p>3-2</p>  <p>17-17T</p>
<p>4-1</p>  <p>12-D1/8*17 12-D3/16*17</p>	<p>4-2</p>  <p>12-17T</p>
<p>5-1</p>  <p>19-D1/8*17 19-D3/16*17</p>	<p>5-2</p>  <p>19-17T</p>
<p>6-1</p>  <p>18-D1/8*17 18-D3/16*17</p>	<p>6-2</p>  <p>18-17T</p>

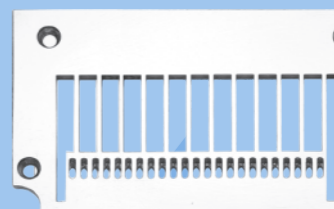
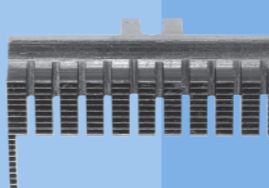
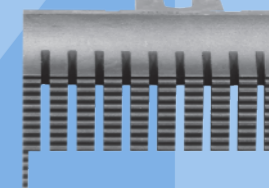
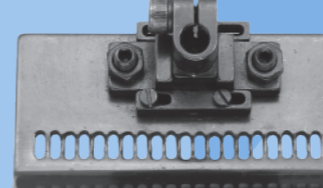
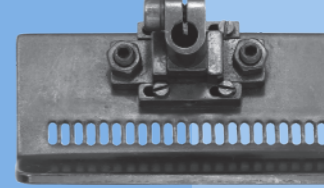
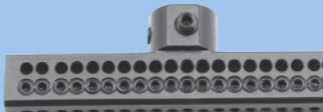
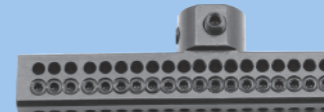

FOR KANSAI SPECIAL/关西

1412P

<p>21×1/8</p> <p>1-1</p>  <p>14-D1/8*21</p>	<p>23×1/8</p> <p>1-2</p>  <p>14-D1/8*23</p>
<p>2-1</p>  <p>15-D1/8*21</p>	<p>2-2</p>  <p>15-D1/8*23</p>
<p>3-1</p>  <p>17-D1/8*21</p>	<p>3-2</p>  <p>17-D1/8*23</p>
<p>4-1</p>  <p>12-D1/8*21</p>	<p>4-2</p>  <p>12-D1/8*23</p>
<p>5-1</p>  <p>19-D1/8*21</p>	<p>5-2</p>  <p>19-D1/8*23</p>
<p>6-1</p>  <p>18-D1/8*21</p>	<p>6-2</p>  <p>18-D1/8*23</p>



FOR KANSAI SPECIAL/关西

1412P

23×1/8/T

1-1



14-D1/8*23T

23×1/8.H

1-2

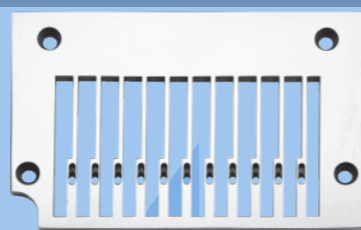

14-376

2-1

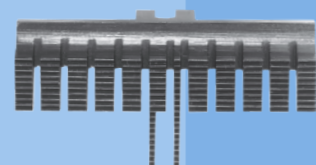

15-D1/8*23T

2-2

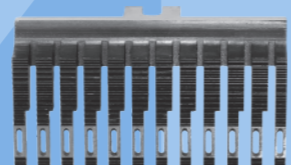

15-376

3-1

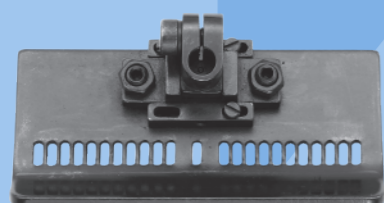

17-D1/8*23T

3-2

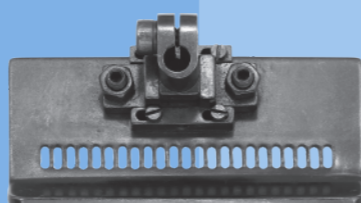

17-D1/8*23

4-1

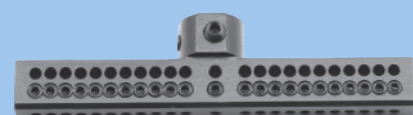

12-D1/8*23T

4-2

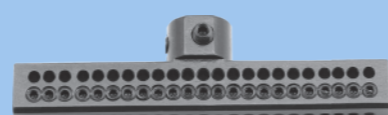

12-D1/8*23

5-1



19-D1/8*23T

5-2



19-D1/8*23

6-1

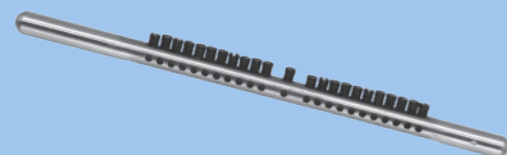

18-D1/8*23T

6-2

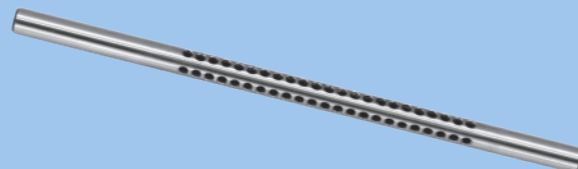

18-D1/8*23



FOR KANSAI SPECIAL/关西

1412P

25×1/4

1-1

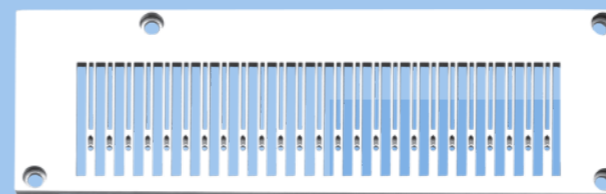

14-022

25×1/4.A

1-2



14-022.A

2-1



15-024

2-2

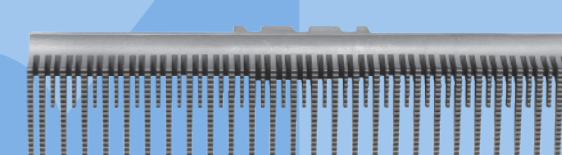

15-024.A

3-1

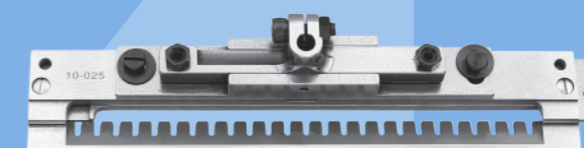

10-025-0

4-1



12-0250-1

5-1



19-025



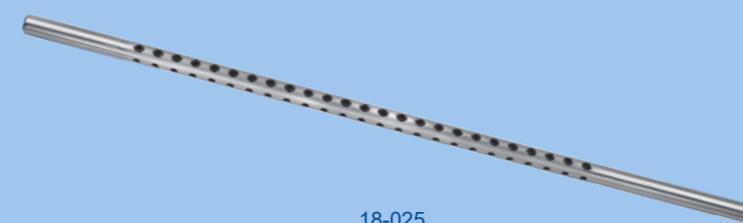

6-1



18-025

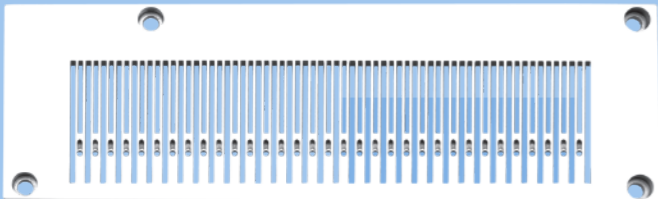

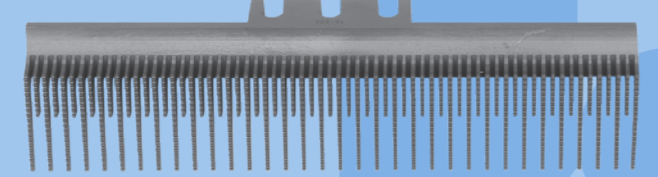
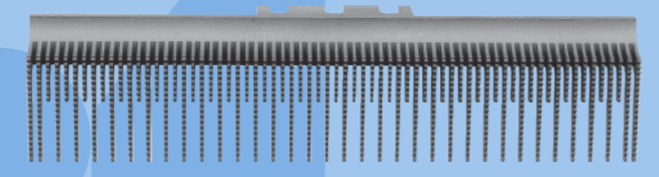
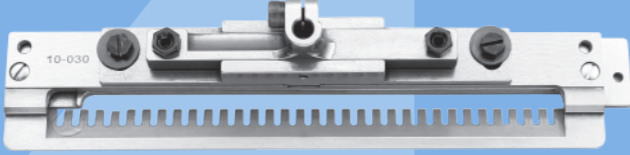

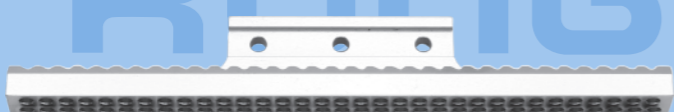
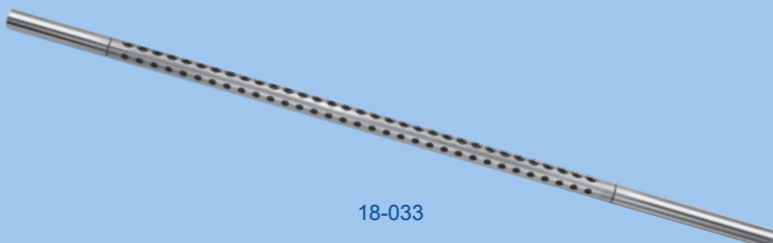







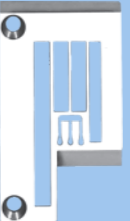

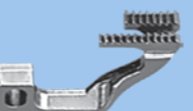
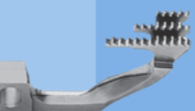





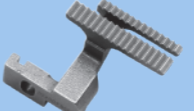
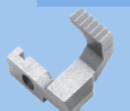
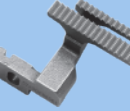

FOR KANSAI SPECIAL/关西

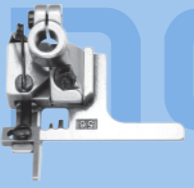
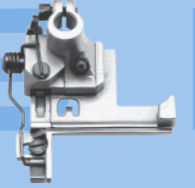
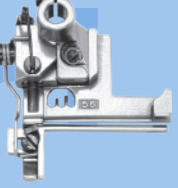
1412P	
33×1/4	33×1/4.A
1-1  14-023	1-2  14-023.A
2-1  15-034	2-2  15-034.A
3-1  10-030-0	
4-1  12-0330-1	
5-1  19-033	
6-1  18-033	



FOR KINGTEX/宝狮

SH6005-C32 -C52	SH6034-D03 -M45	CT-8556	CT-9042	CTD-9085		
M16	M45	3×5.6 3×6.4	3×5.6 3×6.4	2×4.0 2×4.8	3×5.6 3×6.4	
1-1  TP605C32 TP605C52	1-2  TP634D03	1-3  5220TP85560 5220TP85561	1-4  5220TP42562 5220TP42642	1-5  5220TP85400 5220TP85480	1-6  5220TP85560 5220TP85640	
2-1  DF85209	2-2  DF86108	2-3  5220FD85561	2-4  5220FD42562	2-5  5220FD85561		
3-1  FD60828	3-2  FD60842	3-3  5220DF85561	3-4  5220DF42562	3-5  5220DF85561		
4-1  PF605C32		4-2  PF634D03	4-3  5220PF85560 5220PF85641	4-4  5220PF42561 5220PF42641	4-5  5222PF85400 5222PF85480	4-6  5222PF85560 5222PF85640
5-1  NC605032	5-2  NC605048	5-3  5220NC00561 5220NC00641	5-4  5220NC00561 5220NC00641	5-5  5220NC00400 5220NC00480	5-6  5220NC00561 5220NC00641	



工业缝纫机针位组
GAUGE SET FOR INDUSTRIAL SEWING MACHINES
INDUSTRIAL SEWING MACHINES SPARE PARTS

FOR KINGTEX/宝狮

FOR PEGASUS/飞马

CTD-9311		L52-01	L52-05S1	L52-16S2	L52-17
2×4.0 2×4.8	3×5.6 3×6.4	0×3 0×4	2×3 2×4	0×1.5	0×4
1-1	1-2	1-3	1-4	1-5	1-6
5220TPL1400 5220TPL1480	5222TPL1560 5222TPL1640	202617 205773	202702 202675	205465	202546E
2-1	2-2	2-3	2-4	2-5	
5220FDL1561	204730-BF	204693-BF	204730	204676-BF	
3-1	3-2	3-3	3-4	3-5	
5220DFL1561	204729-ABF 204674 208090-BF	204692ABF 204674	204729A 208912 208911	204675A 204674 208078-BF	
4-1	4-2	4-3	4-4	4-5	4-6
5222PFL1400 5222PFL1480	5222PFL1560 5222PFL1640	208525	208525	208525	208525
		201152E/201155C	208730/208731 208730/208732	201230C/205525	201230C/201224B
5-1	5-2	5-3	5-4	5-5	
5220NC00400 5220NC00480	5220NC00561 5220NC00641	209670-92	208905	209670-92	

工业缝纫机针位组
GAUGE SET FOR INDUSTRIAL SEWING MACHINES
INDUSTRIAL SEWING MACHINES SPARE PARTS

























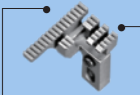

FOR PEGASUS/飞马

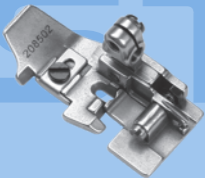
L52-13	L52-51 L52-52	L32-31 L32-33	L32-34 L32-35	L32-38 L32-39	L32-48 F32-48 L32-49 F32-49
2×3 2×4	2×4	3×3 3×4	3×3 3×4	3×3 3×4 3×5	3×3 3×5
1-1	1-2	1-3		1-4	1-5
205255 202554E	205243	204294B 204039B		204366 204367 204368	204939 204941
2-1		2-2	2-3	2-4	2-5
204676-BF		208215	208217	208219	204420
3-1	3-2	3-3	3-4	3-5	3-6
204675A 204674 208078-BF	204675A 204677 208079-BF	204248B 208059 208063	204394 208059 208064	204396 208060 208066	204931 208061 208074
4-1	4-2	4-3	4-4	4-5	
208525	208525	208501	208504	208508	
208730/208731 208730/208732	205253/201310A				
5-1	5-2				
208905	208909				



工业缝纫机针位组
GAUGE SET FOR INDUSTRIAL SEWING MACHINES
INDUSTRIAL SEWING MACHINES SPARE PARTS

FOR PEGASUS/飞马

L32-70 L32-71	L32-76	L32-86 L32-87	L32-355 L32-359	M752-01	M752-17
5×5 5×6	5×5	5×5 5×6	3×2×4	0×4	0×4
1-1	1-2	1-3	1-4	1-5	1-6
					
204360A 204361A	204380	204528 204529	208648	205773	202546E
2-1	2-2	2-3	2-4	2-5	2-6
					
208215	208225	208217	208219	204730-BF	204676-BF
3-1	3-2	3-3	3-4	3-5	
					
204248B 208059 208063	204394 208059 208064	204396 208060 208066	204729ABF 204674 208090-BF	204675ABF 204674 208078-BF	
4-1	4-2	4-3	4-4	4-5	
					
208502	208506 208955	208649	208525 201152E/201155C	208525 201230C/201224B	
5-1	5-2	5-3			
					
208910	208965	209670-92			

















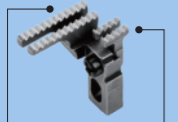
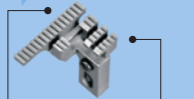
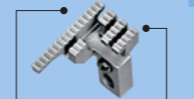

工业缝纫机针位组
GAUGE SET FOR INDUSTRIAL SEWING MACHINES
INDUSTRIAL SEWING MACHINES SPARE PARTS

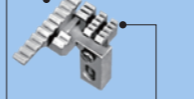

FOR PEGASUS/飞马

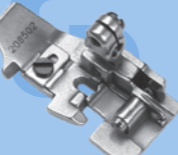
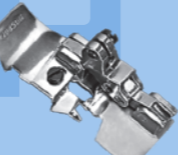
M752-16S1 M752-16S2	M752-180	M752-53 M752-54A	M752-13	M752-23B	M752-55A
0×1.5	0×4	0×4	2×3 2×4	2.5×4.5	2×4
1-1	1-2	1-3	1-4	1-5	1-6
					
205465	202618A	205321	205255 202554E	209508-45	202983
2-1	2-2	2-3	2-4	2-5	2-6
					
204730	204730A16F	204693	204676-BF	209417A25F	204693-BF
3-1	3-2	3-3	3-4	3-5	3-6
					
204729A 208912 208911	204729B16F 204674 208090A16F	204692A 204677 208083	204675ABF 204674 208078-BF	209416-25F 204674 209509-25F	204692ABF 204677 208083-BF
4-1	4-2	4-3	4-4	4-5	4-6
					
208525 201230C/205525	208525 201473B/301433	208525 212182/210371	208525 208730/208731 208730/208732	208525 201230C/208050A	208525 212182/201310A
5-1	5-2	5-3	5-4		
					
209670-92	208905	208906A92	208905		















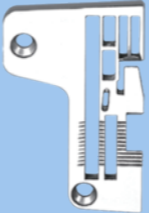

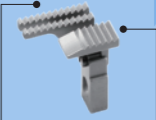

FOR PEGASUS/飞马

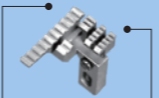
M752-181	M732-36	M732-38	M732-70	M732-86
2×4	3×3 3×4 3×5		5×5 5×6	5×5 5×6
1-1  209732	1-2  204366 204367 204368		1-3  204360A 204361A	1-4  204528 204529
2-1  209742-16F	2-2  208218	2-3  208219	2-4  208215	2-5  208217
3-1  209741-16F 204677 209740-16F	3-2  204395 204425 208065	3-3  204396 208060 208066	3-4  204248B 208059 208063	3-5  204394 208059 208064
4-1  208525 205253/209734	4-2  208501	4-3  208504	4-4  208502	4-5  208506 208955
5-1  208905A92	5-2  208909B92		5-3  208910B92	

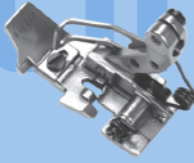
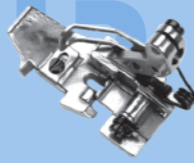
FOR PEGASUS/飞马

M732-48	M732-48P2	M732-354 M732-355	M852-16S2	M852-01
3×4		3×2×4	0×1.5	0×4
1-1  204940		1-2  208648	1-3  2054651	1-4  2057731
2-1  204420		2-2  208219	2-3  2047300	2-4  204730-BF0
3-1  204931 208061 208074		3-2  204396 208060 208066	3-3  204729A0 2089120 2089110	3-4  204729ABF0 2046740 208090-BF0
4-1  208508	4-2  204502A	4-3  208649	4-4  274018-92B0 201230C0/2055250	4-5  274018-92B0 201152E0/201155C0
5-1  208909B92		5-2  208965B92	5-3  179630-920	













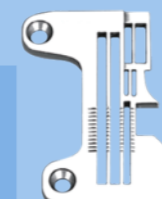

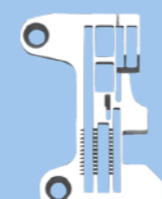
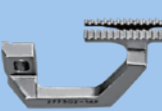
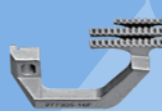
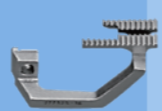
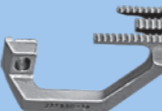
FOR PEGASUS/飞马

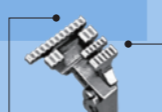
M852-17	M852-13	M832-38	M832-70	M832-86
0×4	2×4 2×5	3×4	5×5	5×5
1-1	1-2	1-3	1-4	1-5
				
202546E1	202554E1 202499E1	2043671	204360A1	2045291
2-1	2-2	2-3	2-4	
				
204676-BF0	2082190	2082150	2082170	
3-1	3-2	3-3	3-4	
				
204675ABF0 2046740 208078-BF0	2043960 2090600 2080660	204248B0 2080590 2080630	2043940 2080590 2080640	
4-1	4-2	4-3	4-4	4-5
				
274018-92B0 201230C0/2103710	274018-92B0 2087300/2087321	2771180	2771190	2771220
5-1	5-2	5-3	5-4	
				
179630-920	277022920	277027-921	277029-920	

















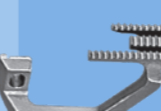

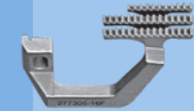
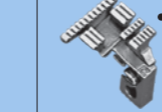

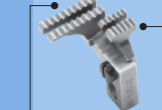
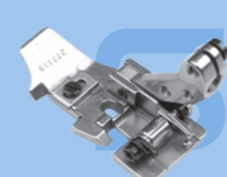

FOR PEGASUS/飞马

EX5204-01/223K	EX5204-02/223K	EX5203-22/233K	EX5205-12/233K EX5203-12/233K	EX5204-32R2/223(K)
0×3 0×4	0×3 0×4 0×5	0×5 0×6	0×3 0×4	0×1.5
1-1	1-2	1-3	1-4	1-5
				
277500P30 277500P40	277504R30 277504R40 277504R50	277504R50 277504R60	277500P30 277500P40	277512P15
2-1	2-2	2-3	2-3	
				
277302-16F	277305-16F	277302-16F	277302-16F	
3-1	3-2	3-3	3-4	3-5
				
277301-16F 277318-13 277300-16F	277304-16F 277318-13 277303-16F	277304-16F 277318A13 277303A16F	277301-16F 277318-13 277300-16F	277301-16F 277309-13 277315-16F
4-1	4-2	4-3	4-4	
				
274018-92B 201230C/210370 201230C/210371	274018-92B 202799/210371 202799/210372	274018-92B 201152E/277115 201152E/277103	274018-92B 202799/205525	
5-1				
				
	179630-92			

FOR PEGASUS/飞马

EX5204-32R2/223L(K)	EX5212-02/333K	EX5214-53/333K EX5214-53C3/333K	EX3216-02/223K	EX3216-03/223K
0×1.5	2×3 2×4 2×5	2×4 2×5	3×4 3×5	3×4 3×5
1-1  277502P15	1-2  277505R30 277505R40 277505R50	1-3  277505R40 277505R50	1-4  277513R40 277513R50	1-5  277517R40 277517R50
2-1  277302-16F	2-2  277305-16F	2-3  277325-16	2-4  277330-16	
3-1  277301-16F 277309-13 277315-16F	3-2  277304-16F 277318-13 277303-16F	3-3  277324-16 277318-13 277323-16	3-4  277328-16 277318-13 277327-16	
4-1  274018-92B 202799/205525	4-2  274018-92B 201230C/210503 201230C/210374	4-3  274018-92B 277112/208651	4-4  277118	
5-1  179630-92	5-2  277022-92	5-3  277027-92		

FOR PEGASUS/飞马

EX3216-03/223K	EX3216-04/435K	EX3244-03-333K	EXT5204-02-233K	EXT5214-43/333K
5×5 5×6	5×5 5×6	3×2×4	0×4	2×4
1-1  277516R50 277516R60	1-2  277524T50 277524T60	1-3  277518R40	1-4  277504R400	1-5  277505R400
2-1  277329-16	2-2  277339-25	2-3  277329-16	2-4  277305-16F0	
3-1  277328-16 277318-13 277327-16	3-2  277338-25 277318-13 277337-25	3-3  277328-16 277318-13 277327-16	3-4  277304-16F 277318-13 277303-16F	
4-1  277119	4-2  277122	4-3  277118A0	4-4  2773440	4-5  2773450
5-1  277028-92	5-2  277029-92	5-3  277030-92	5-4  277149-400	5-5  277151-400
6-1  179630-920	6-2  277022-920			



工业缝纫机针位组

GAUGE SET FOR INDUSTRIAL SEWING MACHINES

INDUSTRIAL SEWING MACHINES SPARE PARTS

FOR PEGASUS/飞马

EXT3215-02 /233K	W522-04B	W561 W562-01 CB/CC		
3×4	2×6.4	2×3.2 2×4.0 2×4.8	3×4.8	3×5.6 3×6.4
1-1 277513R400	1-2 257180-64	1-3 	1-4 	1-5
2-1 277325-160	2-2 259246-16F	2-3 257258-16F	2-4 257259-16F	
3-1 277324-160 277318-130 277323-160	3-2 259136-16F	3-3 257206-16F	3-4 257207-16F	
4-1 2773200	4-2 PE238	4-3 		
5-1 277153-400	5-2 257522-64	4-4 		
6-1 277027-920	6-2 252058-92	5-3 	5-4 	
	7-1 252059-92			



工业缝纫机针位组

GAUGE SET FOR INDUSTRIAL SEWING MACHINES

INDUSTRIAL SEWING MACHINES SPARE PARTS

FOR PEGASUS/飞马

W562-01CA	W561-03 DB W562-03 DB	W562-03DC	W561 W562-02 BB/BC	
3×5.6	3×5.6 3×6.4	3×5.6	2×3.2	2×4.0 2×4.8
1-1 257018A56	1-2 257090B56 257090B64	1-3 257090C56	1-4 257029B32	1-5 257030B40 257030B48
2-1 257259-16F	2-2 257253-16F	2-3 257259-16F	2-4 257260-16F	2-5 257261-16F
3-1 257207-16F			3-2 257214-16F	3-3 257215-16F
4-1 257461-56	4-2 257468-56 257468-64	4-3 		
5-1 257518-56	5-2 257518-56 257518-64	5-3 257518-56	5-4 257517-32	5-5 257517-40 257517-48











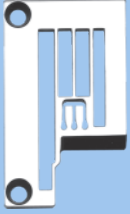

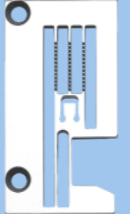









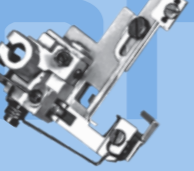
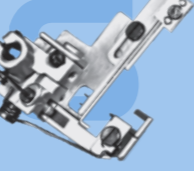

工业缝纫机针位组

GAUGE SET FOR INDUSTRIAL SEWING MACHINES

INDUSTRIAL SEWING MACHINES SPARE PARTS

FOR PEGASUS/飞马

W561 W562-02 BB/BC	W561-05BB	W561-05 BB W562-05 BB		W561 W562-01 DB
3×5.6 3×6.4	3×4.8	2×3.2 2×4.0 2×4.8	3×5.6 3×6.4	4×6
1-1  257033B56 257033B64	1-2  257051B48	1-3  257049B32 257050B40 257050B48	1-4  257053B56 257053B64	1-5  257020-60
2-1  257262-16F	2-2  257267-16F	2-3  257266-16F 257267-16F 257267-16F	2-4  257268-16F	2-5  257256-16F
3-1  257216-16F	3-2  257221-16F	3-3  257220-16F 257221-16F 257221-16F	3-4  257222-16F	3-5  257203A16F
4-1  257321A56 257321A64	4-2  257330A48	4-3  257327A32 257328A40 257328A48	4-4  257331A56 257331A64	4-5  257491-60
5-1  257518-56 257518-64	5-2  257518-48	5-3  257517-32 257517-40 257517-48	5-4  257518-56 257518-64	5-5  257513-60













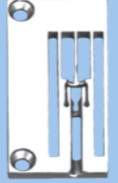

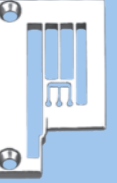









工业缝纫机针位组

GAUGE SET FOR INDUSTRIAL SEWING MACHINES

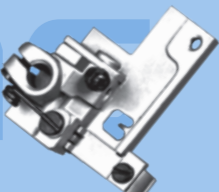













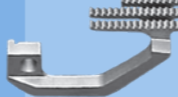
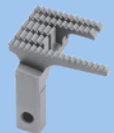

INDUSTRIAL SEWING MACHINES SPARE PARTS

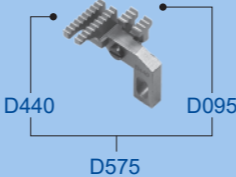

FOR PEGASUS/飞马

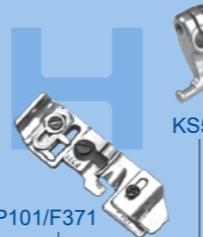
W664-01 CB		W664-03 FB	W664-02 BB		
2×3.2 2×4.0 2×4.8	3×5.6 3×6.4	3×5.6 3×6.4	2×3.2 2×4.0 2×4.8	3×5.6 3×6.4	
1-1  257015B32 257015B40 257015B48	1-2  257018B56 257018B64	1-3  257097B56 257097B64	1-4  257029B32 257030B40 257030B48	1-5  257033B56 257033B64	
2-1  257289-16F	2-2  257290-16F	2-2  259215-16F	2-3  257291-16F 257292-16F 257292-16F	2-4  257293-16F	
3-1  257242-16F	3-2  257243-16F	3-2  259103-16F	3-3  257244-16F 257245-16F 257245-16F	3-4  257246-16F	
4-1  257460-32 257460-40 257460-48	4-2  257461-56 257461-64	4-3  257468-56 257468-64	4-4  257317A32 257318A40 257318A48	4-5  257321A56 257321A64	
5-1  257517-32 257517-40 257517-48	5-2  257518-56 257518-64	5-3  257518-56 257518-64	5-4  257517-32 257517-40 257517-48	5-5  257518-56 257518-64	







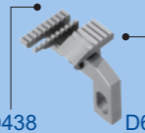
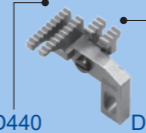



FOR PEGASUS/飞马

W664-34 AB	W664-35 BB	W1662-32B	737-504M2	
2×4.0 2×4.8	3×5.6 3×6.4	3×5.6 3×6.4	04(0×4)	04LFC-2(0×4)
1-1  257100B40 257100B48	1-2  257102B56 257102B64	1-3  2Q0018B56D 2Q0018B64D	1-4  E800	
2-1  259202-16F	2-2  259203-16F	2-3  3G0007016F09	2-4  H445	
3-1  259100-16F	3-2  259101-16F	3-3  259110-16F	3-4  D440 D095 D575	
4-1  257485-40 257485-48	4-2  257486-56 257486-64	4-3  3Q00390356 3Q00390364	4-4  P253E/F371 P253E-3	4-5  P101/F371 P101-3
5-1  257517-40 257517-48	5-2  257518-56 257518-64	5-3  257542-56 257542-64	5-4  KG131	

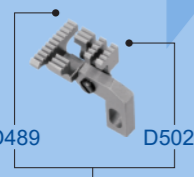
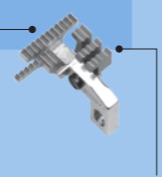
FOR SIRUBA/银箭

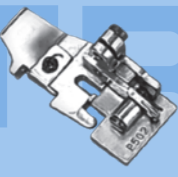
737-505F1	737-504M1	747-504M3	747-512M1	747-514M2	
03(0×3) 04(0×4)	15(0×4)	04(0×4)	24(2×4) 25(2×5)	24LF-B(2×4)	24TG-B(2×4)
1-1  E783 E784	1-2  E934	1-3  E919	1-4  E809 E810	1-5  E809	1-6  E805
2-1  H442	2-2  H445				
3-1  D438	3-2  D438	3-3  D440	3-4  D440		
4-1  P152D/F155 P152D-3	4-2  P152D/F525 P152D-A	4-3  P253E/F374 P253E-4	4-4  P101/F374 P101-4	4-5  P254G/F504G P254G-4	
5-1  KG131	5-2  KG142				

FOR SIRUBA/银箭

757-516M2			767-516M2	
35(3×5)	55(5×5)	56(5×6)	324(3×2×4)	524(5×2×4)
1-1  E982	1-2  E986	1-3  E868	1-4  E989	1-5  E988
2-1  H497	2-2  H500	2-3  H501	2-4  H497	2-5  H500
3-1  D489 D502 D581	3-2  D490 D502 D582	3-3  D971 D502	3-4  D972 D502	
4-1  P504	4-2  P502	4-3  P955	4-4  P233-A	4-5  P255-A
5-1  KG153	5-2  KG155	5-3  KG333	5-4  KG355	

FOR SIRUBA/银箭

737K-504M2	747K-514M2	757K-516M2	757K-516M2	767K-516M2
04(0×4)	24(2×4)	35(3×5)	55(5×5)	324(3×2×4)
1-1  E222	1-2  E229	1-3  E217	1-4  E218	1-5  E219
2-1  H204	2-2  H208	2-3  H209		
3-1  D210 D207	3-2  D208 D207			
4-1  P201-4A P201-A	4-2  P504J-A	4-3  P502J-A	4-4  P233J-A	
5-1  KG231K-E	5-2  KG242K-E	5-3  KG253K-E	5-4  KG255K-E	5-5  KG433K-E















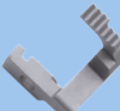

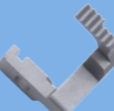
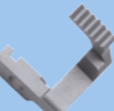





工业缝纫机针位组

GAUGE SET FOR INDUSTRIAL SEWING MACHINES

INDUSTRIAL SEWING MACHINES SPARE PARTS

FOR SIRUBA/银箭

C007E-U222/CQ	C007E-W122/CH		C007E-W222/CQ	C007E-W152/CZ
3×5.6	2×4.0	3×5.6 3×6.4	2×4.0	3×5.6
1-1  E4426P	1-2  E3524P	1-3  E3826P E3827P	1-4  E4124P	1-5  E4326P
2-1  H3362	2-2  H4258 H4259	2-3  H3362	2-4  H3262	
3-1  D3216	3-2  D4206 D4207	3-3  D3216		
4-1  P2116-A	4-2  P0024	4-3  P0216-A P0217-A	4-4  P1814	4-5  P2416-A
5-1  M4356	5-2  M4240	5-3  M4356 M4364	5-4  M4240	5-5  M4356











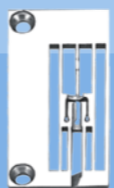





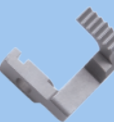
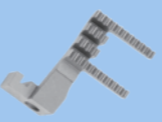

工业缝纫机针位组

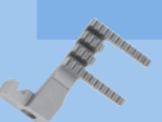
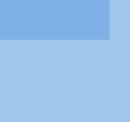
GAUGE SET FOR INDUSTRIAL SEWING MACHINES

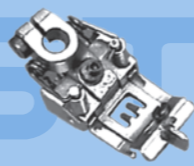

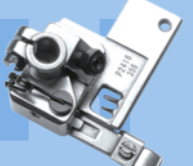













INDUSTRIAL SEWING MACHINES SPARE PARTS

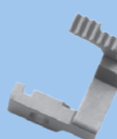
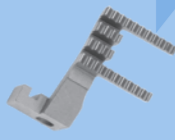
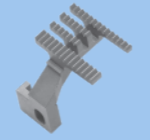

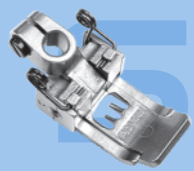

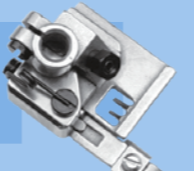



















FOR SIRUBA/银箭

C007E-W332/CD	C007E-W332/CE	C007H-W122/CH C007H-W122CH/UTP(UTP)		C007H-W152 CZ/UTP/RLO
3×5.6	3×5.6	2×4.0 2×4.8	3×5.6 3×6.4	3×5.6
1-1  E3626P	1-2  E2626P	1-3  E3524P E3525P	1-4  E3826P E3827P	1-5  E4326P
2-1  H4158	2-2  H3159	2-3  H4258	2-4  H4258 H4259	2-4  H3262
3-1  D4206	3-2  D2107	3-3  D4206	3-4  D4206 D4207	3-4  D3216
4-1  P1406	4-2  P0024 P0025	4-3  P0216-A P0217-A	4-4  P2416-A	
5-1  M4356	5-2  M5240 M5248	5-3  M5356 M5364	5-4  M5356	

FOR SIRUBA/银箭

C007H-W162 C007H-U162	C007JD-W121/CH	C007H-W222/CQ	F007J-W222	F007H-W222CQ
3×5.6 3×6.4	3×5.6 3×6.4	2×4.0 2×4.8	2×4.0 2×4.8	3×5.6 3×6.4
1-1  E3846 E3847	1-2  E3826 E3827	1-3  E4124P E4125P	1-4  E3024 E3025	1-5  E4426P E4427P
2-1  H4258 H4259	2-2  H4458 H4459	2-3  H3362	2-4  H1261	2-5  H3362 H3363
3-1  D4206 D4207	3-2  D3216	3-3  D1215	3-4  D3216 D3217	
4-1  P0226-A P0227-A	4-2  P2446-A P2447-A	4-3  P1814 P1815	4-4  P2116-A P2117-A	
5-1  M5356 M5364	5-2  M5240 M5248	5-3  M5356 M5364		

FOR SIRUBA/银箭

F007E-W122/UTG	F007E-W122/FQ	F007E-W222/FQ	F007E-W322/FDC	F007E-W922/FW
2×4.0 2×4.8	3×5.6 3×6.4	3×5.6 3×6.4	3×5.6	4×6.0
1-1  E1524 E1525	1-2  E1826 E1827	1-3  E3326 E3327	1-4  E4826	1-5  E1828
2-1  H1258	2-2  H1259	2-3  H1262	2-4  H1359	2-5  H1259
3-1  D1206	3-2  D1207	3-3  D1216	3-4  D1207	
4-1  P0024 P0025	4-2  P0216-A P0217-A	4-3  P2116-A P2117-A	4-4  P1406	4-5  P2408
5-1  M4240 M4248	5-2  M4356 M4364	5-3  M4356	5-4  M4460	













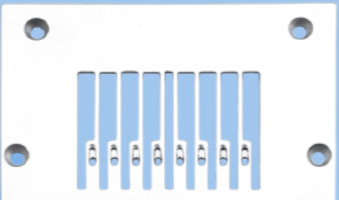
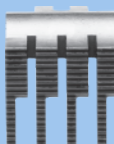
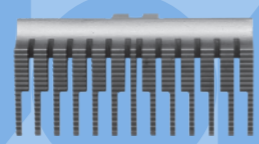
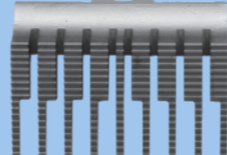

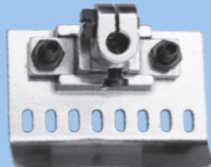

工业缝纫机针位组

GAUGE SET FOR INDUSTRIAL SEWING MACHINES

INDUSTRIAL SEWING MACHINES SPARE PARTS

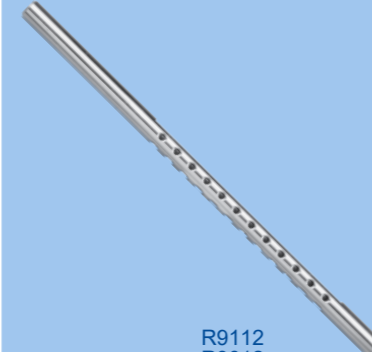
SIRUBA/银箭

VC008-04085P	VC008-06064P VC008-06048P	VC008-08064P
4×1	6×1/4 6×3/16	8×1/4
1-1  E9104D	1-2  E9112 E9012	1-3  E9108
2-1  D9104	2-2  D9112 D9012	2-3  D9108
3-1  P9104-A	3-2  P9512D-A P9412D-A	3-3  P9108-A
4-1  M9104	4-2  M9112 M9012	4-3  M9108
5-1  L9104	5-2  L9112 L9012	5-3  L9112
6-1  R9104	6-2  R9112 R9012	6-3  VUT109P











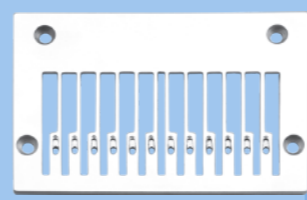

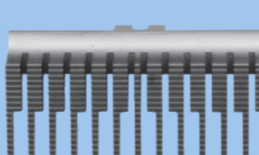
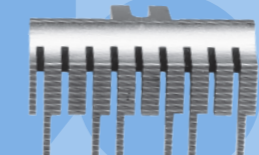
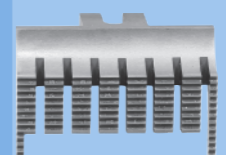
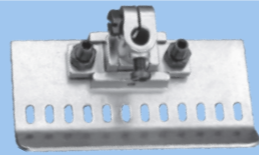
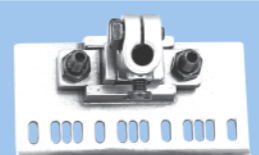
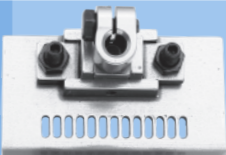

工业缝纫机针位组

GAUGE SET FOR INDUSTRIAL SEWING MACHINES

INDUSTRIAL SEWING MACHINES SPARE PARTS











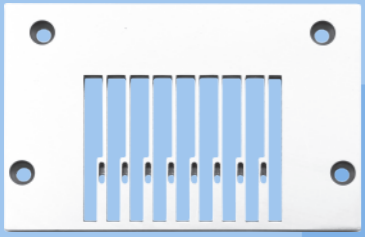

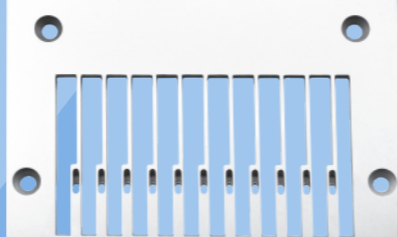
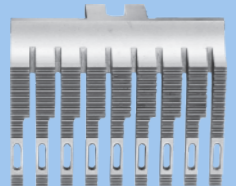
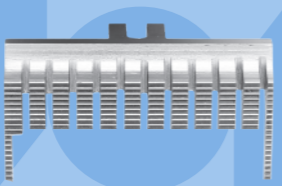
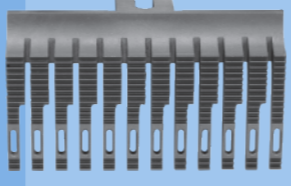
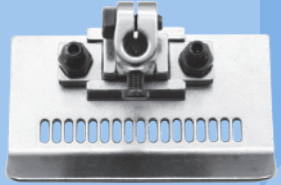
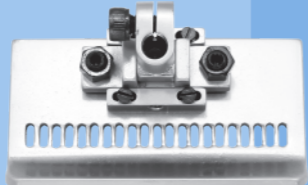
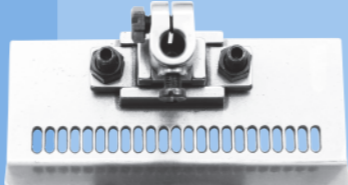
SIRUBA/银箭

VC008-12064P VC008-12048P	VC008-1332-032P	VC008-13064P
12×1/4 12×3/16	(1/4×1/8×1/4)×3	13×1/8
1-1  E9112 E9012	1-2  E9113	1-3  E9313
2-1  D9112 D9012	2-2  D9113	2-3  D9313
3-1  P9112D-A P9012D-A	3-2  P9113D-A	3-3  P9313-A
4-1  M9112 M9012	4-2  M9113	4-3  M9313
5-1  L9112 L9012	5-2  L9119P-E	5-3  L9313
6-1  R9112 R9012	6-2  R9113	6-3  R9313



工业缝纫机针位组
GAUGE SET FOR INDUSTRIAL SEWING MACHINES
INDUSTRIAL SEWING MACHINES SPARE PARTS

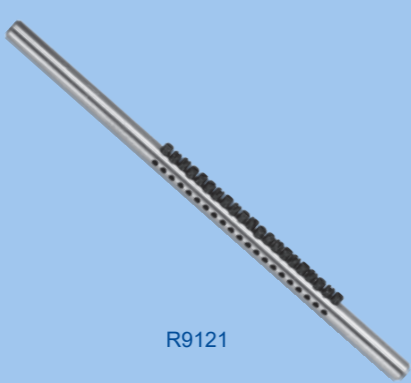













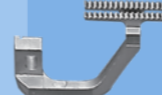

FOR SIRUBA/银箭

VC008-17	VC008-21	VC008-23
17×1/8.H (牙齿含针眼)	21×1/8	23×1/8.H (牙齿含针眼)
1-1  E9117A	1-2  E9121	1-3  E9123A
2-1  D9117A	2-2  D9121	2-3  D9123A
3-1  P9117-A	3-2  P9121-A	3-3  P9123-A
4-1  M9117	4-2  M9121	4-3  M9123
5-1  L9117	5-2  L9121	5-3  L9123
6-1  R9117	6-2  R9121	6-3  R9123

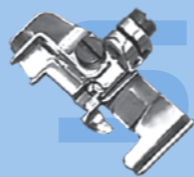

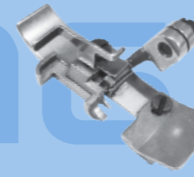







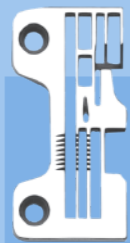



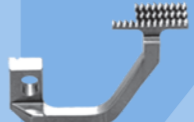

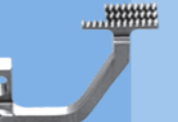
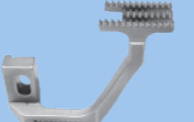
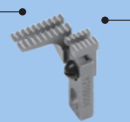

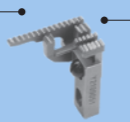
工业缝纫机针位组
GAUGE SET FOR INDUSTRIAL SEWING MACHINES
INDUSTRIAL SEWING MACHINES SPARE PARTS

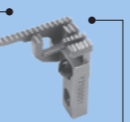
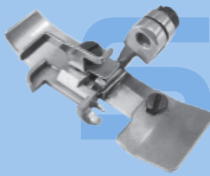
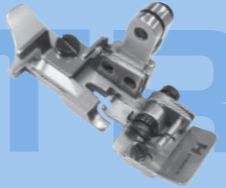
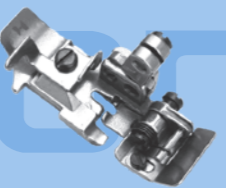
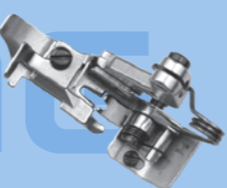













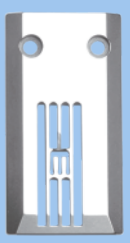
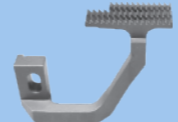
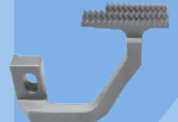



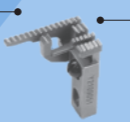

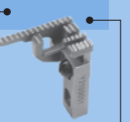
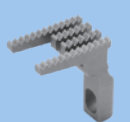
FOR YAMATO/大和

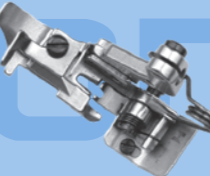
AZ8000H	AZ8003H		AZ8020H	AZ8020G
04(0×4)	03(0×3)	04(0×4)	2.4×5	
1-1  2108000	1-2  2108002	1-3  2108003	1-4  2108004	
2-1  2109000	2-2  2109007	2-3  2109005		
3-1  2109001	3-2  2109067	3-3  2109006	3-4  2109067	
4-1  2107032	4-2  2107300	4-3  2107301	4-4  2107310	4-5  2157058
5-1  2109100	5-2  2109101	5-3  2159102		

FOR YAMATO/大和

























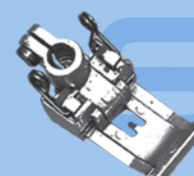
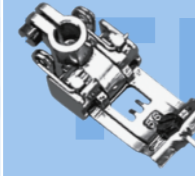

AZ8025H	AZ8500H		AZ8500G	
2.4×6	2×4	5×5	2×4	5×5
1-1  2108005	1-2  2108050	1-3  2108052	1-4  2108050	1-5  2108052
2-1  2109009	2-2  2109050	2-3  2109055	2-4  2109050	2-5  2109055
3-1  2109006	3-2  2109051	3-3  2109056	3-4  2109051	3-5  2109056
4-1  2107311	4-2  2107100	4-3  2107102	4-4  2157310	4-5  2157315
5-1  2109101	5-2  2109110	5-3  2109112	5-4  2159111	5-5  2159112

FOR YAMATO/大和

AZ6020H New	CZ6020H New	CZ6500H New	AZ6500H New	VT1500 New
2.4×6	2.4×6	2×4	5×5	3×5.6
1-1  2108005	1-2  2108005	1-3  2108050	1-4  2108052	1-5  6508043
2-1  2109005	2-2  2109009	2-3  2109050	2-4  2109055	2-5  6509002
3-1  2109006	3-2  2109006	3-3  2109056	3-4  2109056	3-5  6509013
4-1  2157057	4-2  2107118	4-3  2157310	4-4  2157315	4-5  6507013
5-1  6209100	5-2  6209100	5-3  6209101	5-4  6209112	5-5  6509103



























FOR YAMATO/大和

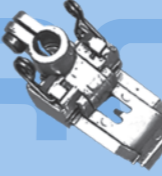
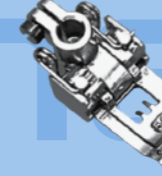
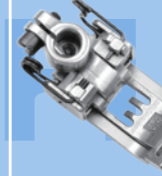









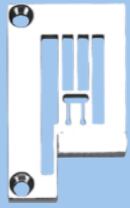



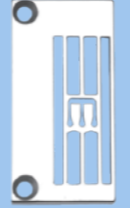











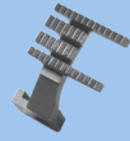

VF-2200	VF2300	VF2403	VF2403		VF2500
132M(2×3.2) 140M(2×4.0) 148M(2×4.8)	156M(3×5.6)	140M(2×4.0)	148M(2×4.8)	140M-11(2×4.0)	156M(3×5.6)
1-1	1-2	1-3	1-4	1-5	1-6
					
3108130 3108131 3108132	3108134	3208103	94283	95234	94801
2-1		2-2	2-3	2-4	2-5
					
3209001		3209065	3209005	3209009	3209001
3-1		3-2	3-3	3-4	3-5
					
3209080		3209064	3209004	3209008	3209000
4-1	4-2	4-3	4-4	4-5	4-6
					
63318 63319 63320	64041-N	3207151	94217	95238	95587
5-1	5-2	5-3	5-4	5-5	5-6
					
93351 93352 93353	93357	93352	3209102	3209101	3209107

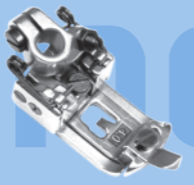



















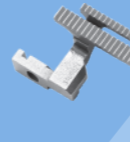





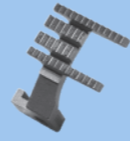

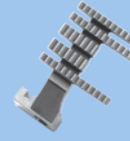
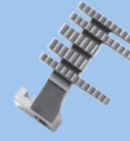
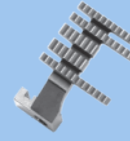
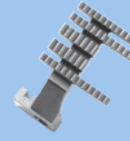
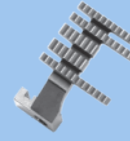
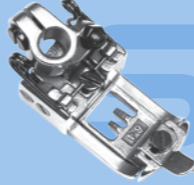

FOR YAMATO/大和

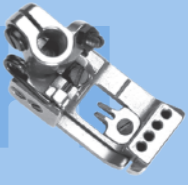
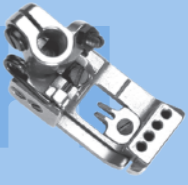
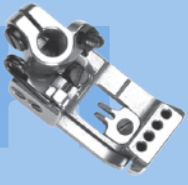
VF2503	VF2503-21	VC2600	VC2700		
156M-11(3×5.6)	156M(3×5.6) 164M(3×6.4)	132M(2×3.2) 140M(2×4.0) 148M(2×4.8)	156L(3×5.6)	156M(3×5.6)	164M(3×6.4)
1-1	1-2	1-3	1-4	1-5	1-6
					
95085	3208108 3208109	93170 93171 93172	95493	94801	94802
2-1	2-2	2-3	2-4		2-5
					
3209009	3209065	3109000	3109000		3109002
3-1	3-2	3-3	3-4		3-5
					
3209008	3209064	3109001	3109001		3109003
4-1	4-2	4-3	4-4		4-5
					
95089	3207156 3207157	63318 63319 63320	64041-N		64042-N
5-1	5-2	5-3	5-4	5-5	5-6
					
3209107	3209107 3209108	93351 93352 93353	93358	93357	93358

FOR YAMATO/大和

VC2603		VC2703		VG2700	
140M-11(2×4.0)		156M-11(3×5.6) 164M(3×6.4)		140M(2×4.0)	
1-1	1-2	1-3	1-4	1-5	1-6
					
95234	95085 94902	3508000	3508001	3508002	3508003
2-1	2-2	2-3	2-4	2-5	2-6
					
3109020 3109022	3509004	3509004	3509004	3509004	3509004
3-1	3-2	3-3	3-4	3-5	3-6
					
3109021	3509005	3509005	3509005	3509005	3509005
4-1	4-2	4-3	4-4	4-5	4-6
					
95238	95089 94909	3507000-N	3507002-N	3507050-N	3507052-N
5-1	5-2	5-3	5-4	5-5	5-6
					
93352	93357 93358	93351	93352	93356	93357

FOR YAMATO/大和

VG2700		VG2735		VG3711		VG3721	
164M(3×6.4)		156M(3×5.6)		164M(3×6.4)		156M(3×5.6) 164M(3×6.4)	
1-1	1-2	1-3	1-4	1-5	1-6	1-7	1-8
							
3508104	3108002	3108003	3118025 3118026	3508098	3508099	3508098	3508099
2-1	2-2	2-3	2-4	2-5	2-6	2-7	2-8
							
3509004	3109024	3119020	3509039	3509036	3509036	3509036	3509036
3-1	3-2	3-3	3-4	3-5	3-6	3-7	3-8
							
3509005	3109025	3119021	3509037	3509037	3509037	3509037	3509037
4-1	4-2	4-3	4-4	4-5	4-6	4-7	4-8
							
3507054-N	3507108	3507111	3117124 3117126	3507060	3507064	3507064	3507064
5-1	5-2	5-3	5-4	5-5	5-6	5-7	5-8
							
93358	93357	93358	93357 93358	93352	93356	93352	93356



工业缝纫机针位组

GAUGE SET FOR INDUSTRIAL SEWING MACHINES

INDUSTRIAL SEWING MACHINES SPARE PARTS

FOR YAMATO/大和

VG3721		VE2713		FD-62G	
156S1(3×5.6)	164S1(3×6.4)	156S-2-K4N (3×5.6)	156L-2-TIN 156L-TIN (3×5.6)	01MR(4×5.2) 01MS(4×6.0)	12MR(4×5.2) 12MS(4×6.0)
1-1 3508100	1-2 3508101	1-3 3158094	1-4 3158082	1-5 68490 68559 68491 68560	1-6 3028015 3028016 68491 68560
2-1 3509036	2-2 3159034 3159019	2-3 3159034 3159012	2-4 68096	2-5 3029019	
3-1 3509037	3-2 3159037	3-3 68095			
4-1 3507064 3107273 3107274	4-2 3507064	4-3 3507052-N	4-4 3027092 3027095	4-5 3027140 3027143 3027143.A (宽刀/Wide knife)	
5-1 93357	5-2 93358	5-3 93357	5-4 68053 68553		

We always bringing you the BEST



Guage part

for industrial sewing machines
工业缝纫机针位零件

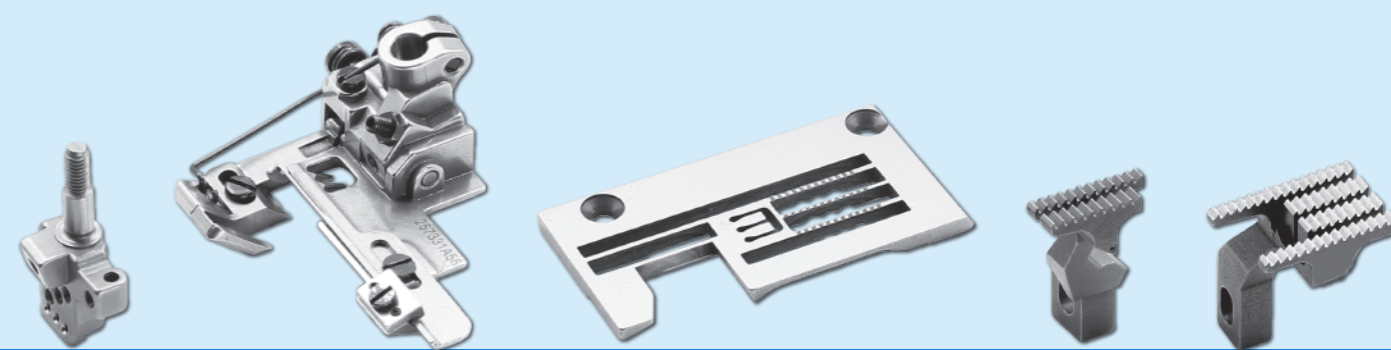

2025-2026

Industrial sewing machine spare components
工业缝纫机零配件部分



强信机械科技
STRONG H MACHINERY TECHNOLOGY

We always bringing you the BEST



Guage part

for industrial sewing machines
工业缝纫机针位零件

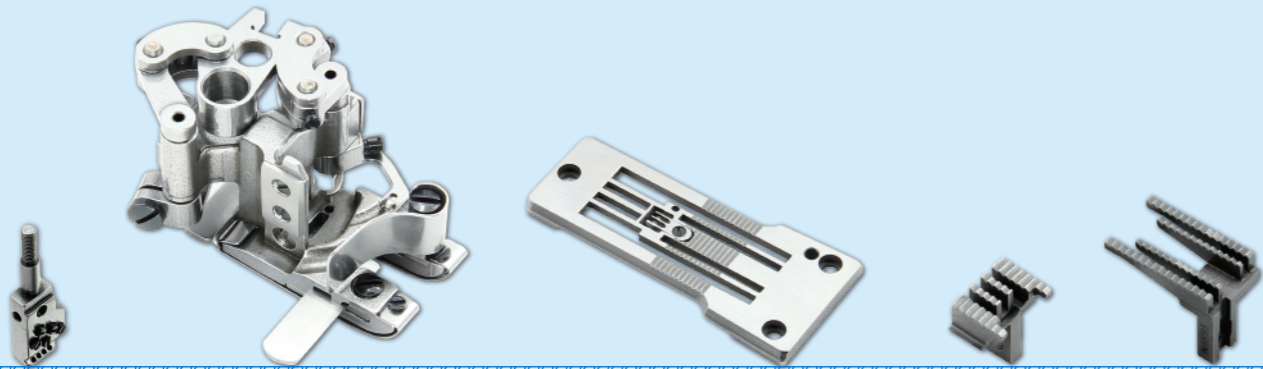

2025-2026

Industrial sewing machine spare components
工业缝纫机零配件部分





















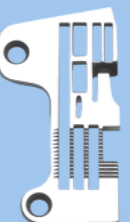

强信机械科技
STRONG H MACHINERY TECHNOLOGY

工业缝纫机针板 NEEDLE PLATE FOR INDUSTRIAL SEWING MACHINES INDUSTRIAL SEWING MACHINES SPARE PARTS

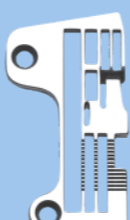

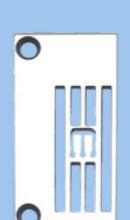
FOR BROTHER/兄弟

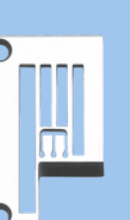
1-1	1-2	1-3	1-4	1-5	1-6	1-7
 S01711	 TE503	 S10570-001 SL-B777(1/8)	 S10572-001 SL-B777(3/16)	 S10573-001 SL-B777(1/4)	 S10574-001 SL-B777(3/8)	 S19156-001 EF4-N11-12-4
146781-001 EF4-B531-022-5(2.2×5) 146782-001 EF4-B531-023-6(2.2×6) 146783-001 EF4-B531-027-7(2.2×7) S01711-001 EF4-B531-022-5(2.2×5) S01713-001 EF4-B531-023-6(2.2×6)						
2-1	2-2	2-3	2-4	2-5		
 146734-001 B511-002-5 146735-001 B511-002-6 146736-001 B511-002-7	 S25527-001 EF4-N21-22-4B	 146781-001.M B531-022-5	 146785-001 B531-031-7	 146786-001 B531-033-5		
3-1	3-2	3-3	3-4	3-5		
 146783-001 B531/B551-027-7	 S01711-001 B531-022-5 S01713-001 B531-022-6	 146498-001 B551-061/062-3	 146505-001 B551-065-6	 146508-001 B551-069-5		
4-1	4-2	4-3	4-4	4-5		
 146509-001 B551-071-6	 S19182-001 MA4-N31-69-5	 S08723-001 FD4-B272-011(3×5.6) S08724-001 FD4-B272-011(3×6.4)	 S08724-001-G FD4-B272-011(3×6.4)	 S08731-001 FD4-B272-021-7(3×5.6) S08732-001 FD4-B272-021-8(3×6.4)		

FOR BROTHER/兄弟

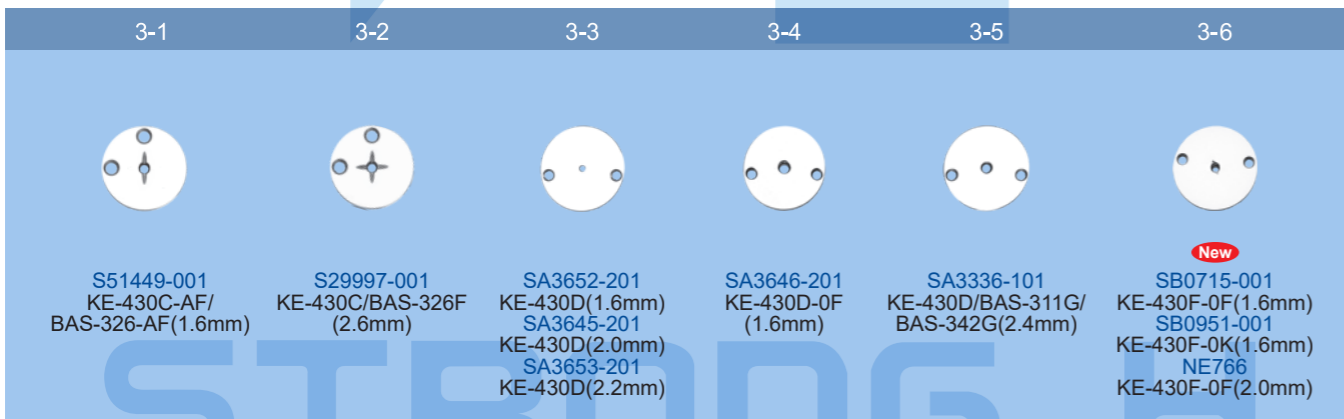
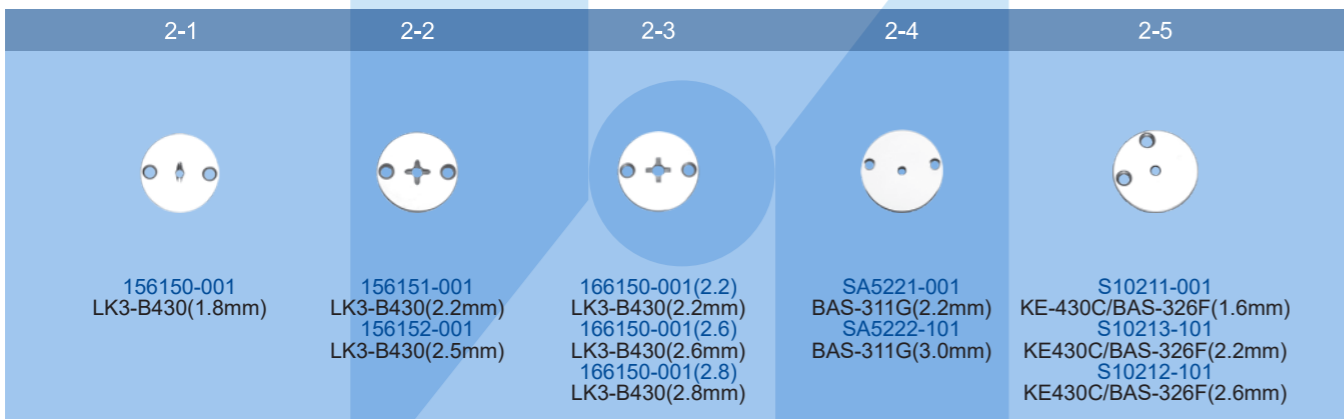
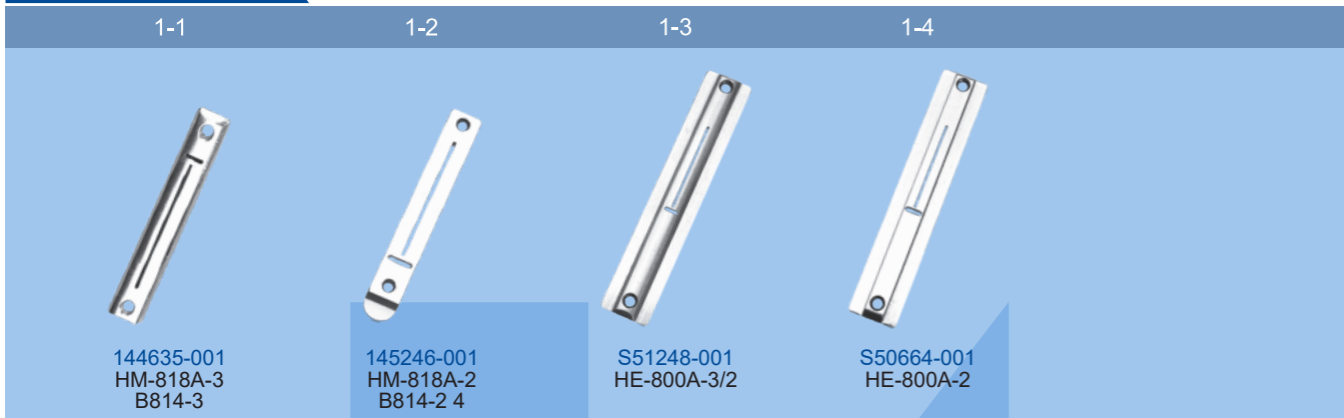



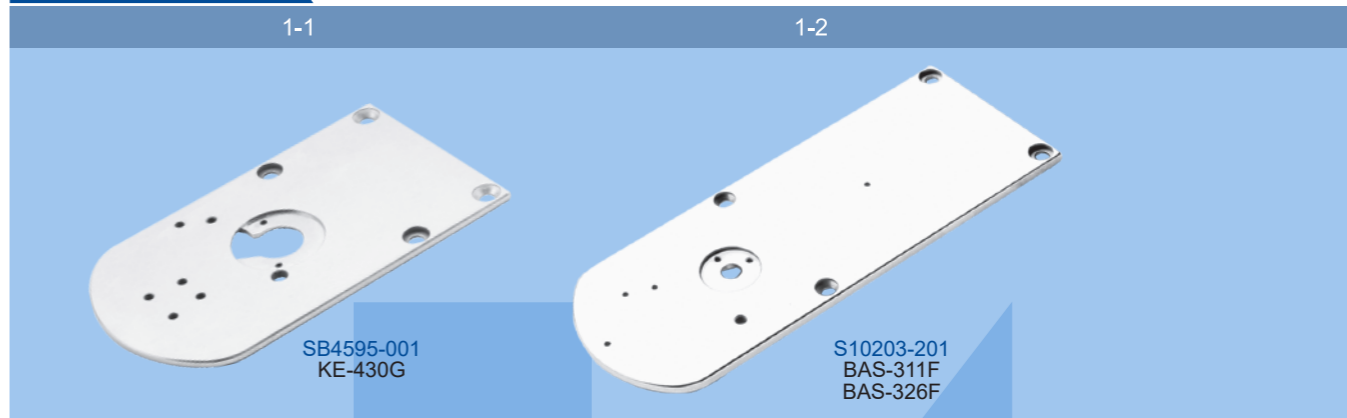



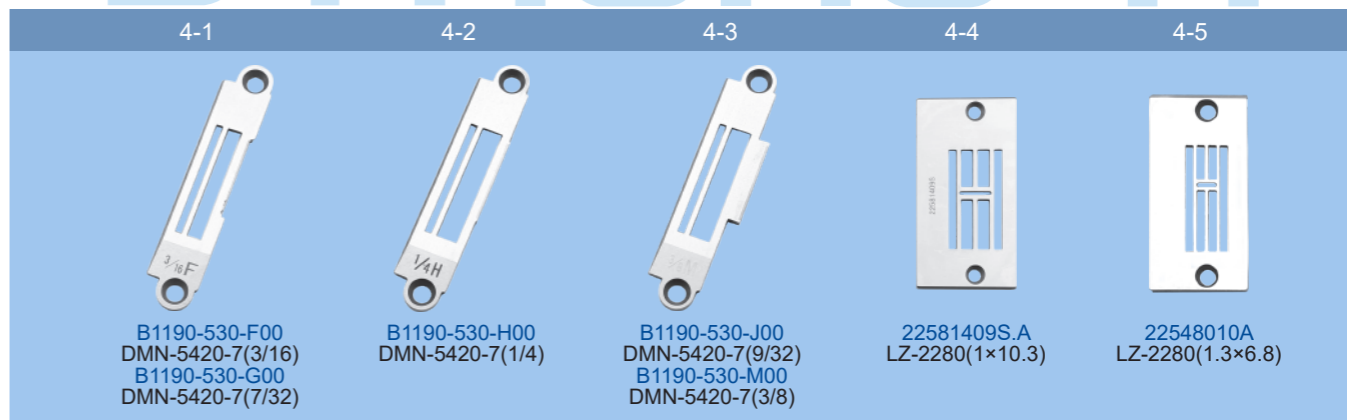
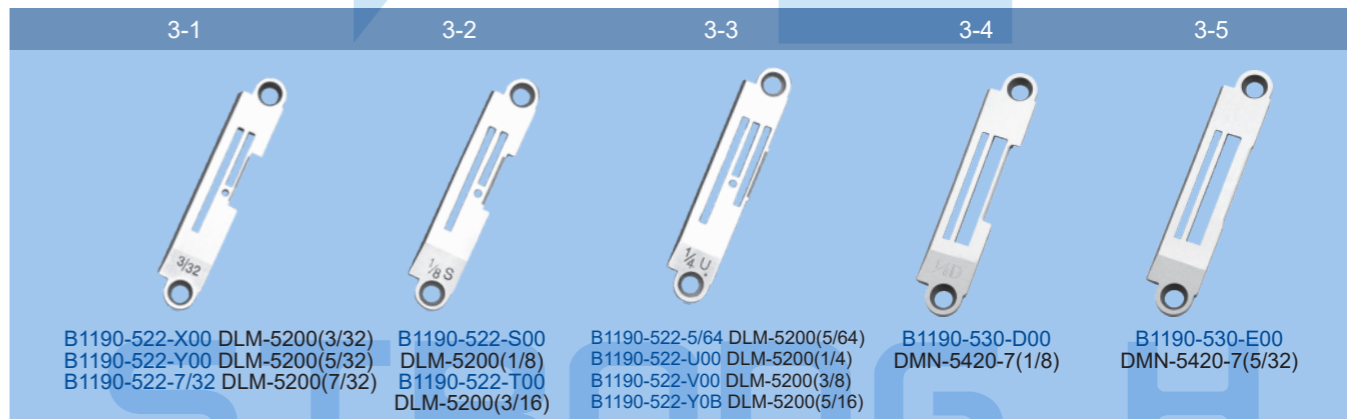
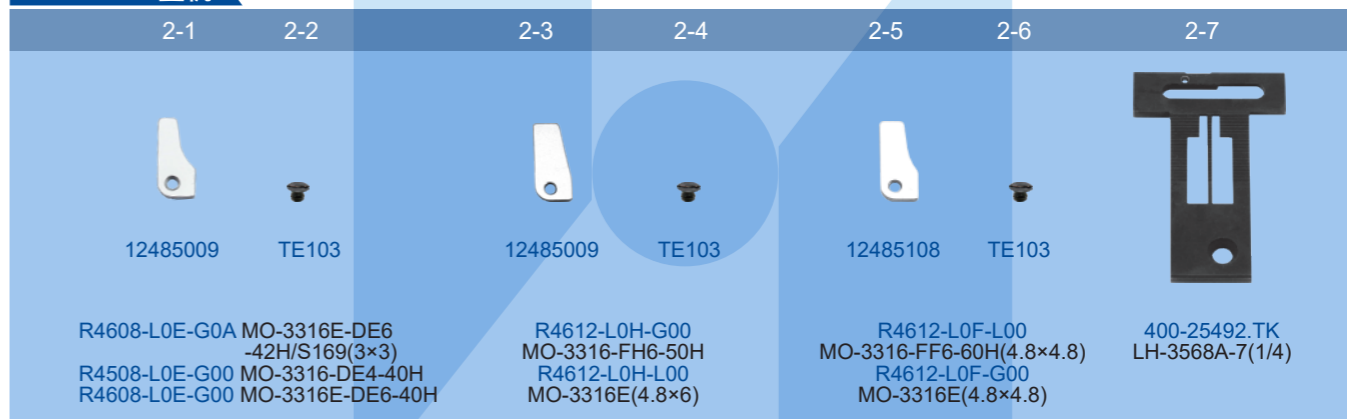





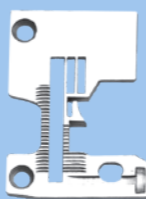
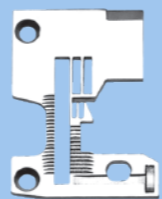
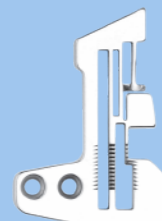

FOR BROTHER/兄弟







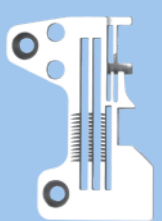
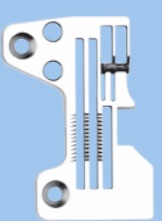
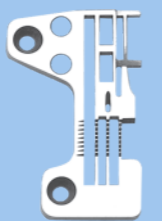





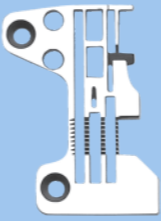

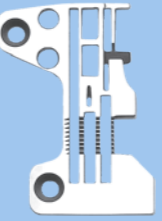
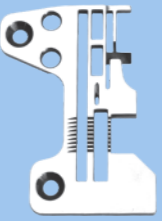







FOR JUKI/重机



FOR JUKI/重机

1-1	1-2	1-3	1-4												
 <table border="1"> <tr><td>400-46301</td><td>10mm</td></tr> <tr><td>400-46302</td><td>12mm</td></tr> <tr><td>400-46303</td><td>14mm</td></tr> <tr><td>400-46304</td><td>16mm</td></tr> <tr><td>400-46305</td><td>18mm</td></tr> <tr><td>400-46306</td><td>20mm</td></tr> </table> <p>APW-895</p>	400-46301	10mm	400-46302	12mm	400-46303	14mm	400-46304	16mm	400-46305	18mm	400-46306	20mm	 <p>B1136-357-A00 MO-357 B1136-357-B00 MO-357 B1136-357-C00 MO-357</p>	 <p>B1137-352-000 MO-352</p>	 <p>B1137-354-000 MO-354</p>
400-46301	10mm														
400-46302	12mm														
400-46303	14mm														
400-46304	16mm														
400-46305	18mm														
400-46306	20mm														
2-1	2-2	2-3	2-4	2-5											
 <p>R4200-LOE-E02 MO-3300</p>	 <p>R4200-EOD-C00 MO-804 R4200-EOD-D0A MO-1004 R4300-EOF-E00 MO-804-OF6</p>	 <p>R4305-EOD-D00 MO-814 R4305-EOD-E0A MO-1014</p>	 <p>R4508-EOD-C00 MO-816</p>	 <p>R4200-JOA-C00 MO-3704</p>											
3-1	3-2	3-3	3-4	3-5											
 <p>R4300-JOE-E00 MO-3904</p>	 <p>R4305-HOF-E00 MO-2514</p>	 <p>R4205-JOE-E00 MO-3914</p>	 <p>R4305-JOD-E00(窄舌) MO-3914 R4305-JOD-E00 MO-3914 R4305-JOE-E00(窄舌) MO-3915 R4305-JOE-E00 MO-3915</p>	 <p>R4305-J6D-E00 MO-6714</p>											
4-1	4-2	4-3	4-4	4-5											
 <p>S4305-JOB-E00 MO-6700</p>	 <p>R4308-J6F-E0B MO-6700</p>	 <p>R4608-HOD-F00 MO-2516 R4608-HOF-G00 MO-2516</p>	 <p>R4508-JOE-D00(窄舌) MO-3916</p>	 <p>R4508-JOD-D00 MO-3916 R4508-JOF-D00 MO-3916</p>											

FOR JUKI/重机

1-1	1-2	1-3	1-4	1-5	
 <p>R4612-JOF-D00 MO-3916 R4612-JOF-F00 MO-3916 R4612-JOF-G00 MO-3916</p>	 <p>R4612-JOF-D0A(窄舌) MO-3916 R4612-JOF-D0A MO-3916</p>	 <p>R4608-JOF-D00 MO-3916 R4608-JOF-D0A MO-3916</p>	 <p>R4508-J6E-D00 MO-6700 R4508-J6E-D0C MO-6700</p>	 <p>R4612-J6F-K00 MO-6700/6500</p>	
2-1	2-2	2-3	2-4	2-5	
 <p>R4253-FOH-G0P MF-8600(2x5.6)</p>	 <p>R4354-FOH-G0B MF-8700(3x6.4)</p>	 <p>B2402-761-000 LBH-761(1.4mm) B2402-762-000 LBH-762(1.4mm)</p>	 <p>B2402-771-000 LBH-780(1.4mm)</p>	 <p>B2402-772-K00 LBH-772(1.1mm)</p>	
3-1	3-2	3-3	3-4	3-5	
 <p>400-27553 LBH-1790(1.4mm) 400-27554 LBH-1790(1.2mm)</p>	 <p>400-04350 LBH-1790(1.4mm) 400-04352 LBH-1790(1.1mm)</p>	 <p>B2426-210-00A AMS-210D(1.6mm) B2426-210-00B AMS-210D(2.0mm) B2426-210-00D AMS-210D(2.4mm) B2426-210-00F.D2.6 AMS-210D(2.6mm)</p>	 <p>B2426-210-00C AMS-210EN(1.6mm) B2426-210-00F AMS-210EN(3.0mm)</p>	 <p>B2426-280-000 LK-1850(1.6mm) B2426-280-00B ALK-1850(2.0mm) B2426-280-00C LK-1850(2.3mm) B2426-280-000.D.2.6 LK-1850(2.6mm)</p>	
4-1	4-2	4-3	4-4	4-5	4-6
 <p>D8.15-11 LK-1850(2.8mm)</p>	 <p>D2426-282-C00 LK-1900/ LK-1900A(1.6mm)</p>	 <p>MAZ-15501000 LK-1903(1.6mm)</p>	 <p>MAZ-15801000 LK-1903A(1.6mm) MAZ-15601000 LK-1903A(2.0mm)</p>	 <p>New 40177342 LK-1900BB</p>	 <p>New 40177343 LK-1900BB</p>

FOR JUKI/重机



FOR JACK/杰克

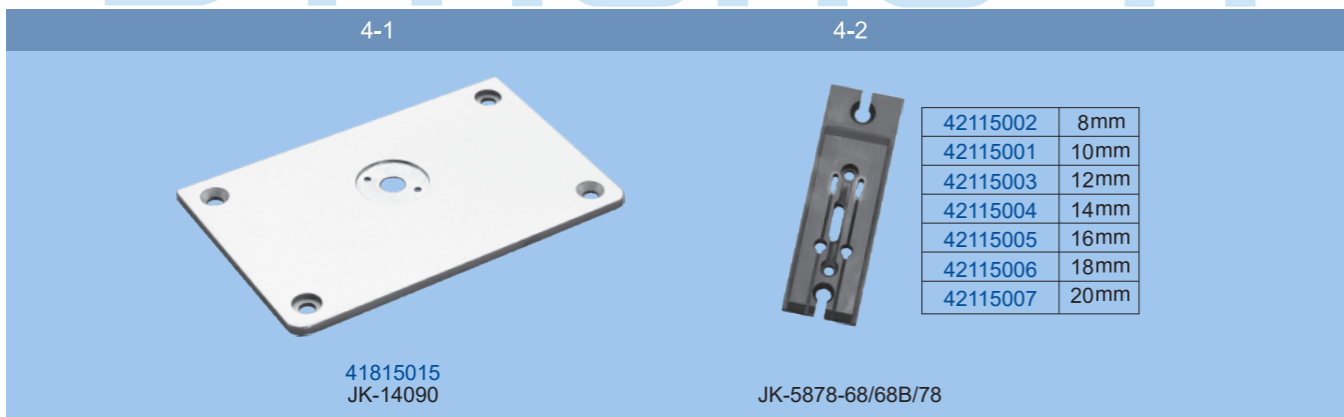
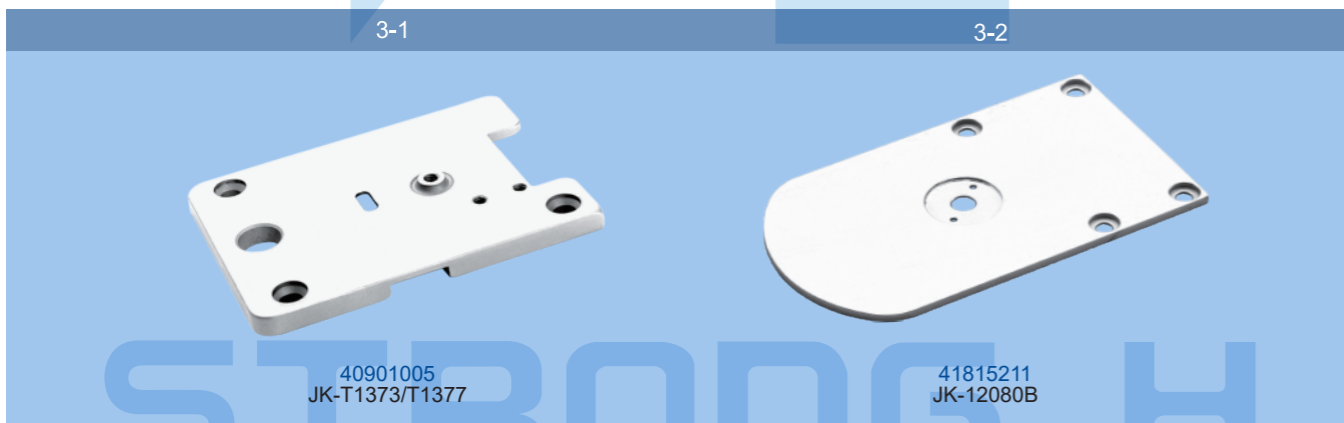
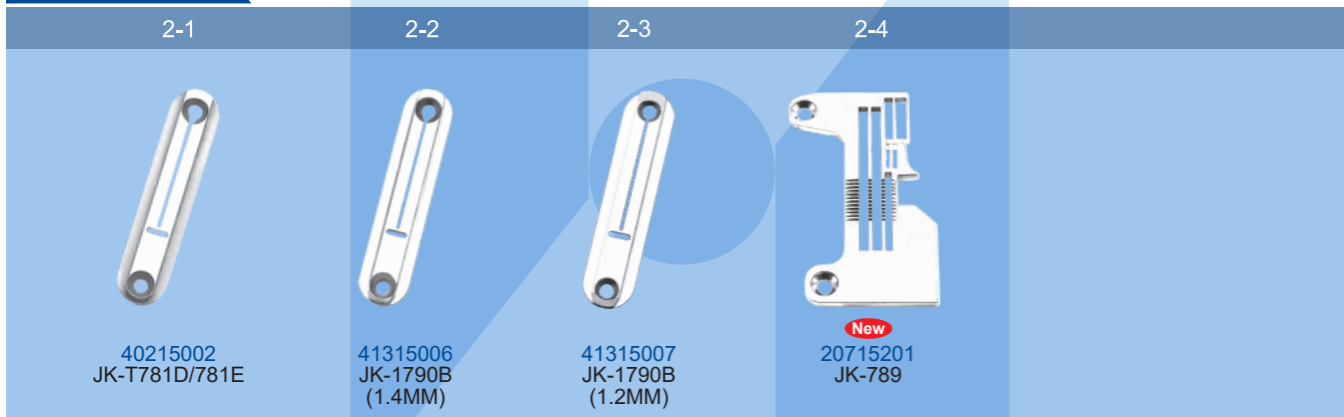

FOR JACK/杰克

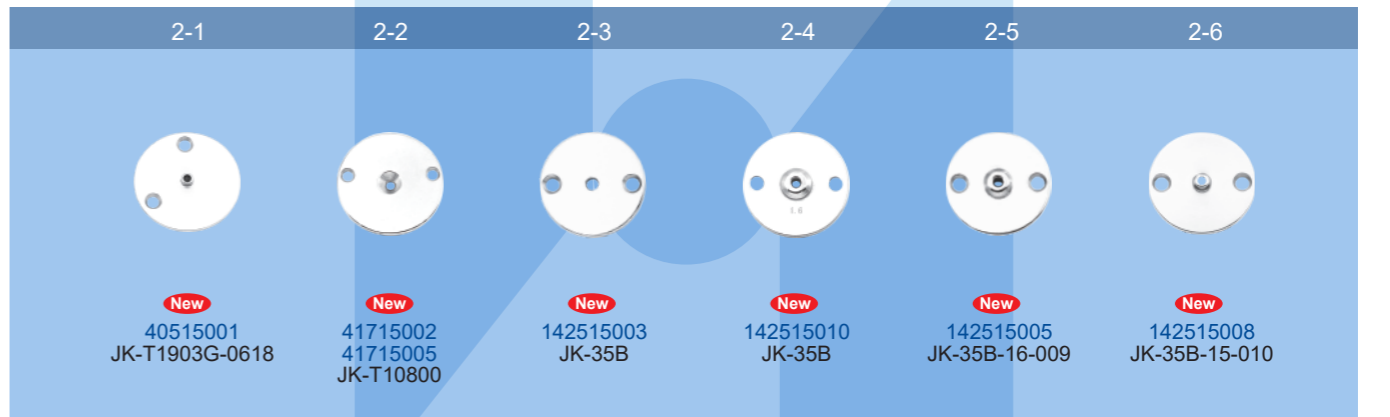
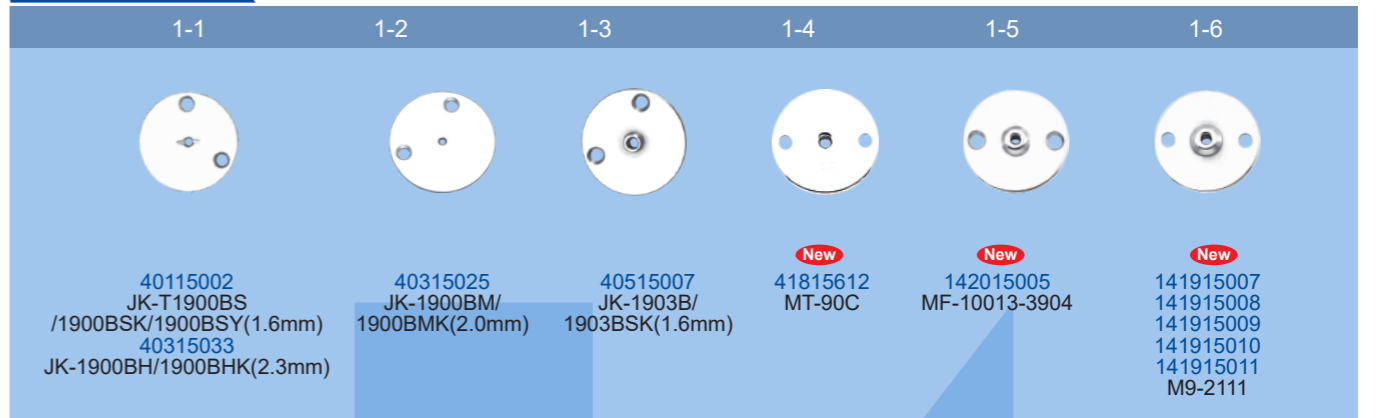

FOR KANSAI SPECIAL/关西

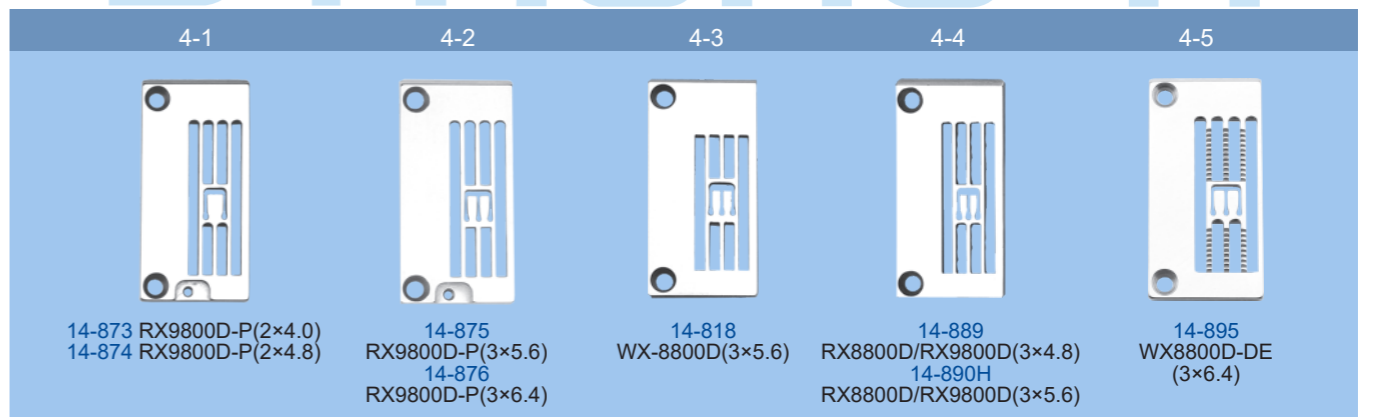
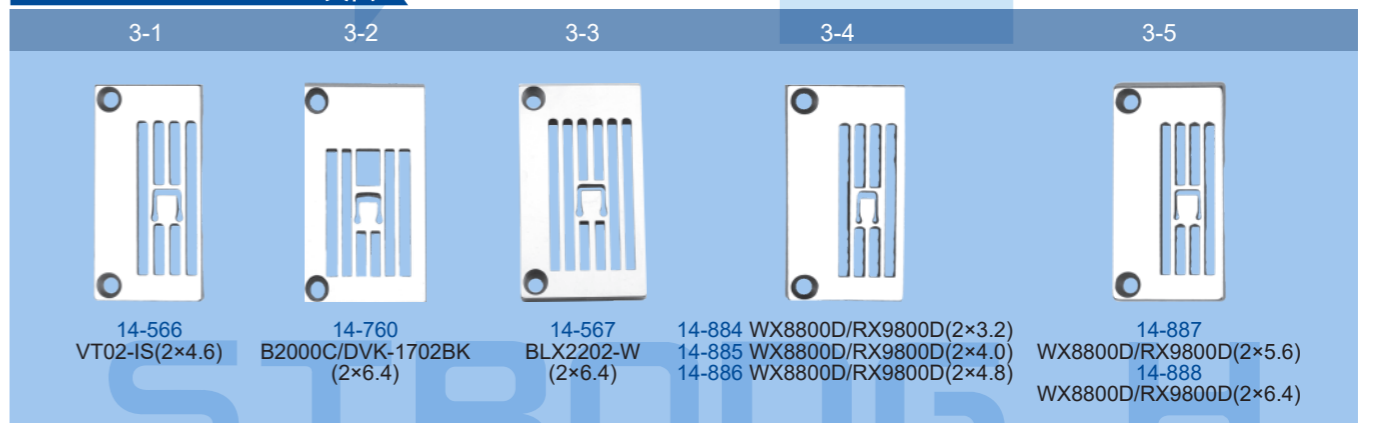



工业缝纫机针板

NEEDLE PLATE FOR INDUSTRIAL SEWING MACHINES

INDUSTRIAL SEWING MACHINES SPARE PARTS

FOR KANSAI SPECIAL/关西

1-1

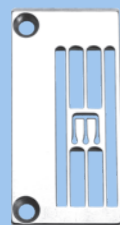

14-871
WX8800D-DW/
RE9800D-CC(3×5.6)

1-2



14-892
WX8800D-AH
(3×6.4)

1-3

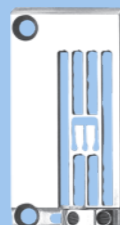

14-897
WX8800D/RX9800D
(3×6.4)

1-4



14-619
NM1102A-CL(3×5.6)

1-5



14-859
W8103(3×5.6)
14-864B
W8103D(3×6.4)

2-1

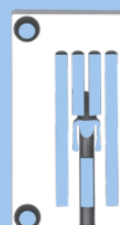

14-843 RX9800D(2×4.8)
14-844 RX9800D(2×5.6)
14-845 RX9800D(2×6.4)

2-2



14-846
WX8800D/RX9800D(3×5.6)
14-847
WX8800D/RX9800D(3×6.4)

2-3



14-861
WX8800D(3×5.6)

2-4



14-854C
W8103D(3×5.6)

2-5



14-854D
W8103D(3×5.6)

3-1



14-8010
W8103C(3×5.6)
14-8020
W8103(3×6.4)

3-2



14-8780-1
WX8800D-CLW(3×5.6)

3-3



14-883
W8103C-C(2×4.8)

3-4



14-882
W8103C-C(3×5.6)

3-5



14-798
NC1104GCL(4×5.6)

4-1



14-705
NU(4×6.4)

4-2



14-186
NW/NR/F(2×3.2)
14-187
NW/NR/F(2×4.0)

4-3



14-857
WX8800D-F(3×4.8)

4-4



14-856B
W8103D-F(3×5.6)
14-866B
W8103D-F(3×6.4)

4-5



14-192
NW/NR/F(3×5.6)

工业缝纫机针板

NEEDLE PLATE FOR INDUSTRIAL SEWING MACHINES

INDUSTRIAL SEWING MACHINES SPARE PARTS



FOR KANSAI SPECIAL/关西

1-1



14-858
W8103D-EMK(3×5.6)
14-868
W8103D-EMK(3×6.4)

1-2



14-728 DWK1802EMK(2×3.2)
14-748 DWK1802EMK(2×4.8)
14-758 DWK1802EMK(2×5.6)
14-768 DWK1802EMK(2×6.4)

1-3



14-771 WX-EMK(2×3.2)
14-772 WX-EMK(2×4.0)
14-773 WX-EMK(2×4.8)
14-774 WX-EMK(2×5.6)
14-775 WX-EMK(2×6.4)

1-4



14-784
WX-EMK(2×3.2)
14-785
WK-EMK(2×4.0)

1-5



14-776
WX-EMK(3×5.6)
14-777
WK-EMK(3×6.4)

2-1



14-779
WX-EMK(3×4.8)

2-2



14-790
WX-EMK(3×5.6)
14-791
WK-EMK(3×6.4)

2-3



14-786
8013-1S(2×4.8)

2-4



14-811
RX9800D-PLK(2×4.0)
14-814
RX9800D-PLK(2×4.8)

2-5



14-870
RX9800D-XLK
(3×4.8)

3-1



14-812
RX9800D-PLK(3×5.6)
14-813
RX9800D-PLK(3×6.4)

3-2

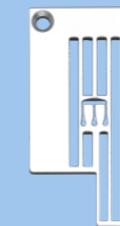

14-782
RX-9803(3×6.4)

3-3



14-3170-1
PX301-4-3FP

3-4



14-611
NM1102A-A(2×4.0)
14-612
NM1102A-A(2×4.8)

3-5



14-183
MZ1100A-UF(2×4.8)
14-184
MZ1100A-UF(3×5.6)

4-1



14-615 NM1102A-A(3×4.0)
14-613 NM1102A-A(3×5.6)
14-614 NM1102A-A(3×6.4)

4-2



14-616
NM1102A-C(2×4.8)

4-3



14-617
NM1102A-C(3×5.6)
14-618
NM1102A-C(3×6.4)

4-4



14-800
RX9800D-J

4-5



LX-045
LX5802(2×8)



工业缝纫机针板

NEEDLE PLATE FOR INDUSTRIAL SEWING MACHINES

INDUSTRIAL SEWING MACHINES SPARE PARTS

FOR KANSAI SPECIAL/关西

1-1	1-2	1-3	1-4	1-5
14-554 DLR1503PTF(3×7.2)	14-582 DLR1508P(3/16-1-3/16) 14-583 DLR1508P(1/4-3/4-1/4)	14-378 NC-ALK(3×7/32)	14-379 NC-ALK(3×1/4)	New 14-712 WX8840D

FOR KINGTEX/宝狮

2-1	2-2	2-3	2-4	2-5
TP2120014 UH80B3021L04	TP6B3022 SH60B3	TP6B30221 SH60B3	5210TPB3022A	TP603032 SH6003

3-1	3-2	3-3	3-4	3-5
TP624A43 SH6024-A43-M14	TP603053A SH6000	TP624A32 SH6004-A32-M14	TP604A33 SH6004-A33-M14	TP604A42 SH6004-A42-M14

4-1	4-2	4-3	4-4	4-5
TP604A43 SH6004 TP604A53 SH6004	TP604B33 SH6004-B33-M14	TP604B53 SH6004-B53-M12	5210TP04A33 SH6004-B33-M14	5210TP04A43 SH6004-A43-M14



工业缝纫机针板

NEEDLE PLATE FOR INDUSTRIAL SEWING MACHINES

INDUSTRIAL SEWING MACHINES SPARE PARTS

FOR KINGTEX/宝狮





1-1	1-2	1-3	1-4	1-5
5210TP04A53 SH6004-A63-M14	5210TP04A63 SH6004-A63-M14	5210TP0015 UH8004-243-M14	5212TP0035 UH8005	TP645C53 SH6045-C53-M16



2-1	2-2	2-3	2-4	2-5
TP675C53 SH6075-C53-M16	5210TP05C52 SH6005-C52	TP605C53 SH6005 TP605D53 SH6005	TP645D53 SH6045-D53-M16	5210TP45D53

3-1	3-2	3-3	3-4	3-5
5212TP0033 SH6000	GTP605D53 SH6005 GTP605D63 SH6005	TP606CA3 SH6006	TP606DA3 SH6006-DA3-M43	TPC00561 FT6500(3×5.6) TPC00641 FT6500(3×6.4)









4-1	4-2	4-3	4-4	4-5
TPC13564 CT6513(3×5.6)	5220TP00568 CT6500-L(3×5.6) 5220TP00646 CT6500-L(3×6.4)	5222TP13562 CT9013-2(3×5.6)	5220TP00564 5220TP00566 FT7039-1-56M(3×5.6)	5222TP11400 FT7011-0-40M (2×4.0)

FOR KINGTEX/宝狮

1-1	1-2	1-3	1-4	1-5
				
5220TP11480 FT7001-0-48M(3×4.8) 5220TP11560 FT7011-0-56M(3×5.6)	TPF60600 FT6760(4×6.0)	5221TP60600 FT6760	5222TP03400 KZ(3×4.0) 5222TP03480 KZ(3×4.8) 5222TP03560 KZ(3×5.6) 5222TP03640 KZ(3×6.4)	5220TP03563 CT4703(3×5.6) 5220TP85641 CT6585(3×6.4)











2-1	2-2
	
TPC42562 CT6542(3×5.6)	TPCL11561 CTL6511(3×5.6)





FOR PEGASUS/飞马



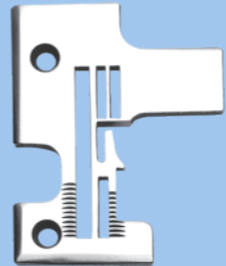

3-1	3-2	3-3	3-4	3-5	3-6	3-7	3-8
							
202554E-T L52-51(2×4)	TE238	204039B L32-31(3×4) 204294B L32-31(3×3)	TE070	204066-T 204943 L32-80	TE070	204367-T 204940 L32-48(3×4) 204944 L32-78/79(5×4)	TE070





4-1	4-2	4-3	4-4	4-5	4-6	4-7	4-8
							
204368 204360A L32-70(5×5) 204368 L32-38(3×5) 204945 L32-78(5×5) 204528 L32-86(5×5)	TE070	204529-2 204361A L32-70(5×6)	TE070	204529-T 204529 L32-86(5×6)	TE070	204939-02 204939 L32-48(3×3)	TE070

FOR PEGASUS/飞马

1-1	1-2	1-3	1-4	1-5	1-6	1-7	1-8	1-9	1-10
									
204941-2 L32-48(3×5)	TE070	210839-2 E32-420/516-213(3×5)	TE103	210840-2 E32-420	TE103	210847-2 E32-430/516-233(3×5)	TE103	257020-60-2 W562-01DB(4×6.0)	TE318

2-1	2-2	2-3	2-4	2-5
				
200954 DCM-204 140135 DCM-204	202403 DCR-942	202618 L52-01	204731A L52-17	210783 E52-211 210784 E52-211

3-1	3-2	3-3	3-4	3-5
				
210796 E52-130 210797 E52-130	210799 E52-130 210800 E52-130	202554E-H M752-13H(2×4)	210804 E52-132 210805 E52-132	210806 E32/E52

4-1	4-2	4-3	4-4	4-5
				
210809 E52-131 210810 E52-131	210837 E32-420 210838 E32-420 210839 E32-420 210840 E32-420	210845 E32-430 210846 E32-430 210847 E32-430 210848 E32-430	210868 E32-451	210980 E32-542 210981 E32-542 210982 E32-542



工业缝纫机针板

NEEDLE PLATE FOR INDUSTRIAL SEWING MACHINES

INDUSTRIAL SEWING MACHINES SPARE PARTS

FOR PEGASUS/飞马

1-1 210987 E32-542	1-2 210986 E32-542	1-3 204943 L32-80 204944 L32-80 204945 L32-80	1-4 213111-60 EX5104	1-5 277502P15 EX5204-32R2
2-1 277505R60 EX5214-03/333K	2-2 277513R50-N EX3216	2-3 277519R40 EX3244-03	2-4 257111C48 W664-81AC (2×4.8)	2-5 259620B56 W562-01J(3×5.6)
3-1 259620B5601 WT2600HENB(3×5.6) 259620B6401 WT2600HENB(3×6.4)	3-2 206276 W561-01(3×5.6) 257001B56 W562-01(3×5.6)	3-3 257082B56 W762L-01CB(3×5.6)	3-4 257105B56 W664-03GB(3×5.6) 257105B64 W664-03GB(3×6.4)	3-5 257108B56 W664-08(3×5.6) 257108B64 W664-08(3×6.4)
4-1 257018B56-N W664-01(3×5.6) 257018B64.H W664-01(3×6.4)	4-2 257018D56 W562-01(3×5.6)	4-3 257018C56 W562-01CC(3×5.6) 257018C64 W562-01CC(3×6.4)	4-4 236035B56 W603(3×5.6)	4-5 257023B32 W562-02SB(2×3.2) 257024B40 W562-02SB(2×4.0)



工业缝纫机针板















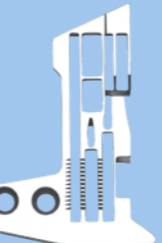

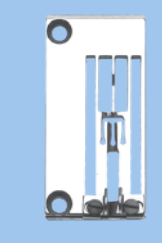
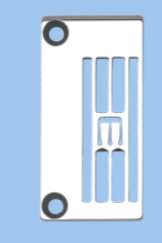

NEEDLE PLATE FOR INDUSTRIAL SEWING MACHINES

INDUSTRIAL SEWING MACHINES SPARE PARTS



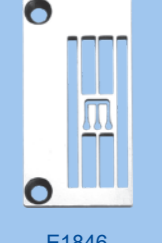







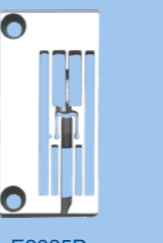



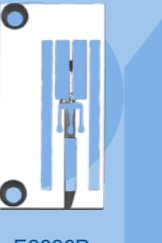

FOR PEGASUS/飞马

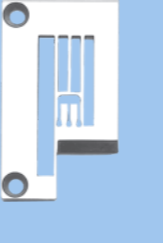
1-1 257032B56 W541-02BB(2×5.6)	1-2 257031B56 W541-02BB(3×5.6) W542-02BB(3×5.6)	1-3 257033A56 W562-02CA(3×5.6) 257033A64 W562-02CA(3×6.4)	1-4 257033C56-18 W562-02(3×5.6)	1-5 257033C56-20 W562-02(3×5.6)
2-1 257067B56 W756-202EB(3×5.6)	2-2 257102B348 W664-35BB	2-3 257102C56 W664-35C(3×5.6) W664-35AB(3×5.6) 257102C6400 W664-35AB(3×6.4)	2-4 259608B56 WT264-03FB(3×5.6)	2-5 259614B56 WT264-01CB(3×5.6)
FOR SIRUBA/银箭				
3-1 E796 737-504M3-04 E797 737-504M3-05	3-2 E800C 737-504M2	3-3 E800D 737-504H4-04	3-4 E589F 737-504M5-04	3-5 E590 737E-504M2/BK
4-1 E591E 747-203BK	4-2 E591F 747F-514/BK	4-3 E591B 747-203BK	4-4 E804 747-514M4-23 E804A 747-512M8-23 E805A 747-512M8-24	4-5 E809A 747-514M7-24 E919A 747-514M7-24

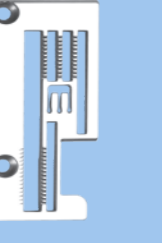
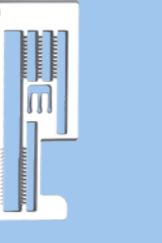
FOR SIRUBA/银箭

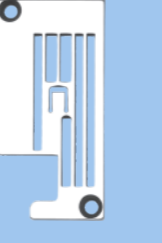
1-1	1-2	1-3	1-4	1-5
				
E810A 747-512M8-25 E920 747-512M1-25 E920A 747-512M8-25	E810L 747	E839 757-516L1-35	E870 757-56	E871 757FX-56
2-1	2-2	2-3	2-4	2-5
				
E871C 757	E232 E232.Gr 737-504M5-04-BK	E226 988-42-514M7	E1836L F007JD-U613(2×5.6) E1837L F007JD-U613(2×6.4)	E1535 F007J-W123(2×4.8)
3-1	3-2	3-3	3-4	3-5
				
E4836M F007J-U322/FDE(3×5.6)	E1816(3×5.6) E1817(3×6.4) F007JD-U121/K	E1825 F007JD-W122/K (3×4.8)	E1826H(3×5.6) F007JD-W121	E1837 F007JD-W123/K
4-1	4-2	4-3	4-4	4-5
				
E1846 F007JD-U162(3×5.6) E1847 F007JD-U162(3×6.4)	E3525P C007JD-U122(2×4.8)	E2324P C007JD-W123/CHE(2×4.0) E2325P C007JD-W123/CHE(2×4.8)	E2326P C007JD-W123/CHE (3×5.6)	E3524R C007JD-W512/FE (2×4.0)

FOR SIRUBA/银箭

1-1	1-2	1-3	1-4	1-5
				
E2625P C007JD-U322/CF (2×4.8)	E3816P C007JD-W123(3×5.6) E3817P C007JD-W123(3×6.4)	E3826-H C007JD-U512/FE-FFC (3×5.6)	E3836 C007JD-W121(3×5.6) E3837 C007JD-W121(3×6.4)	E3826R C007JD-U512/FE(3×5.6) E3827R C007JD-U512/FE(3×6.4)
2-1	2-2	2-3	2-4	2-5
				
E3627P C007JD-U322/CD (3×6.4)	E2627P C007JD-U322/CE (3×6.4)	E2826P C007JD-U322/CC(3×5.6) E2827P C007JD-U322/CC(3×6.4)	E3727 F007J-W222/FSM (3×6.4)	E3326P F007JD/FQ(3×5.6) E3327P F007JD/FQ(3×6.4)
3-1	3-2	3-3	3-4	3-5
				
E4326 C007JD-W152/CQ(3×5.6) E4327 C007JD-W152/CQ(3×6.4) E4327P C007JD-W222(3×6.4)	E6024 F007JD-W522/FE (2×4.0)	E6326 F007JD-W522 FE(FFC)/FR(3×5.6) E6327 F007JD-W522 FE(FFC)/FR(3×6.4)	E4426 C007JD/CQ(3×5.6) E4427 C007JD/CQ(3×6.4)	E6426 C007JD-W532/CRA/UTP CL/RCP/CX(3×5.6)
4-1	4-2	4-3	4-4	4-5
				
E6427P C007JD-U532/CRA (3×6.4)	E0215R C007JD-813(2×4.8)	E0225Q C007JD-W812A (2×4.8)	E0235R C007JD-W813A (2×4.8)	E0216R C007JD-U813(3×5.6) E0217R C007JD-U813(3×6.4)



工业缝纫机针板

NEEDLE PLATE FOR INDUSTRIAL SEWING MACHINES

INDUSTRIAL SEWING MACHINES SPARE PARTS

FOR SIRUBA/银箭

1-1 E0226P C007J-W812/CRL/RL (3×5.6)	1-2 E0226Q C007JD-W812A(3×5.6) E0227Q C007JD-W812A(3×6.4)	1-3 E3966P (3×5.6)	1-4 E3967 (3×6.4)	1-5 E8148P C007J-0092 (2×4.8)
---	---	------------------------------	-----------------------------	--

2-1 E1623 F007F-V122/FP (2×3.2)	2-2 E5827 U712,UT12/FSR (2×6.4)	2-3 E6828 F007J-W722/FY (3×8.8)	2-4 E705Q L818F-RM(1/8) E705R L818F-RM(5/32) E705 L818F-RM(3/16) E705P L818F-RM(3/32)	2-5 E705T L818F-RM(3/8) E705S L818F-RM(1/4)
--	--	--	---	---

FOR YAMATO/大和

3-1 34893 DCZ-200-D1 34894 DCZ-200-D1 36279 DCZ-703	3-2 32671 DCZ-203(2.5mm) 32672 DCZ-203(3.5mm) 32673 DCZ-203(4.5mm)	3-3 34566 DCZ-503-D3	3-4 37289 DC-12 37483 DCY-114	3-5 32666 DCY-114 32667 DCZ-200-D2
--	---	--------------------------------	---	--

4-1 2108017 AZ-8016	4-2 2108008 AZ-6000H/AZ-8000H /AZ-8000G	4-3 2108100 AZ800H-5	4-4 21787 Z5020-Y6	4-5 33353(32678) DCZ-220W-D1
-------------------------------	--	--------------------------------	------------------------------	--



工业缝纫机针板

NEEDLE PLATE FOR INDUSTRIAL SEWING MACHINES

INDUSTRIAL SEWING MACHINES SPARE PARTS

FOR YAMATO/大和

1-1 33353A(4mm) DCZ-220-D1 33353A(5mm) DCZ-220-D1	1-2 34598 DCZ-520-D1	1-3 36304 DZC-724Y	1-4 2108004 AZ8020H-Y5 2108005 AZ8020H-Y6	1-5 6208000 CZ6000(2.4×5) 6208002 CZ6000(2.4×6)
---	--------------------------------	------------------------------	---	---

2-1 2108006 AZ-6020H/AZ-6020H-4 /AZ-8020H/AZ-8000G	2-2 2158003	2-3 2158011	2-4 2108062 AZ8032H-Y5	2-5 2108064 AZ8032H-Y7
---	--------------------	--------------------	----------------------------------	----------------------------------

3-1 27002 ZF-1500-X 27004 ZF-1500-X	3-2 2118009	3-3 33541 DCZ-361A-D2 DCZ-365A/DCZ-367A	3-4 33545 DCZ-361C	3-5 35334 DCZ-341
---	--------------------	--	------------------------------	-----------------------------

4-1 2108050 AZ-8500-A4	4-2 2108052 AZ-8500-C5 2108076 AZ-8500H-C5	4-3 93410 DV1250-M(12×4.0) 93417 DV1266/VC2700 VG2700-M(2×4.8)	4-4 94800 DW1350-MC(3×4.8) 94801-L-DC DW-1350(3×5.6)	4-5 90166 DW-100(3×5.6) 90167 DW-100(3×6.4)
----------------------------------	--	---	--	---



工业缝纫机针板

NEEDLE PLATE FOR INDUSTRIAL SEWING MACHINES

INDUSTRIAL SEWING MACHINES SPARE PARTS

FOR YAMATO/大和

1-1 3108133 VF2300-156M(3×8.4) 3108135 VC-2700(3×6.4)	1-2 3108134.H VF2300-156M(3×5.6) 3108134(厚舌) VC-2700(3×5.6)	1-3 3108134D VF-2300(3×5.6) 3108134.N VF2300-156M(3×5.6)	1-4 3108142-LN (3×5.6)	1-5 94801-L2 VF-2500(3×5.6)
2-1 94801-L2-05 VF-2500(3×5.6)	2-2 94801-LC VF-2500(3×5.6)	2-3 94801C 94801C-L5 VF-2500(3×5.6)	2-4 94801D DW-1350(3×5.6) 94801D-L5 DW-1350(3×5.6)	2-5 94801B VC2700C(3×5.6)
3-1 94802-L5 DW1350/DW1500/DW1700 (3×6.4)	3-2 3008021 VC-2700 (3×5.6)	3-3 3508087 VG2713(P)-156M VG2713-156M	3-4 3108141-N VF-2300(3×5.6) 3108140-NS	3-5 3508008 VC2700(3×5.6)
4-1 3158006 VE-2713-156L (3×5.6)	4-2 3158012 VE-2713-156S (3×5.6)	4-3 3108136 (4×6.0)	4-4 94281 VF-2403(2×3.2)	4-5 94210 DV-1253MA(2×3.2) 94211 DV-1253MA(2×4.0) 94212 DV-1253MA(2×4.8)



工业缝纫机针板

NEEDLE PLATE FOR INDUSTRIAL SEWING MACHINES

INDUSTRIAL SEWING MACHINES SPARE PARTS

FOR YAMATO/大和

1-1 95260 DV-1409(2×3.2)	1-2 95261 DV-1409(2×4.0) 95262 DV-1409(2×4.8)	1-3 3208097 VF-2539(2×3.2)	1-4 90556 DW-303(3×5.6) 90557 DW-303(3×6.4)	1-5 91764 DW-103(3×5.6) 91765 DW-103(3×6.4) 94901 DW-1353(3×5.6)
2-1 3268014 VFS-2511(3×5.6)	2-2 3008025 VF-2503-11(3×6.4)	2-3 3208026 VF-2503(3×4.8)	2-4 3208093 VF-2539(3×5.6) 3208094 VF-2539(3×6.4)	2-5 3118023 VC-3711(2×5.6)
3-1 95278 DW-1509(3×5.6) 95279 DW-1509(3×6.4)	3-2 6508023 VT1500(3×5.6)	3-3 P7-11[4.0] FW-787(2×4.0)	3-4 P7-11[5.6] FW-787(3×5.6)	3-5 P14-18 FW-787(3×5.6)
4-1 FB05[5.6] FW-777(3×5.6)	4-2 FB356-2N FW-777/60(3×5.6)	4-3 VG56311 VG-888(3×5.6)	4-4 D1603-356	4-5 GP-010244 SC7310(3×6.4)

FOR SHING LING/星菱

FOR SHING RAY/星锐

FOR SUN STAR/日星



工业缝纫机针板

NEEDLE PLATE FOR INDUSTRIAL SEWING MACHINES

INDUSTRIAL SEWING MACHINES SPARE PARTS

FOR SINGER/胜家

1-1 1-2 1-3

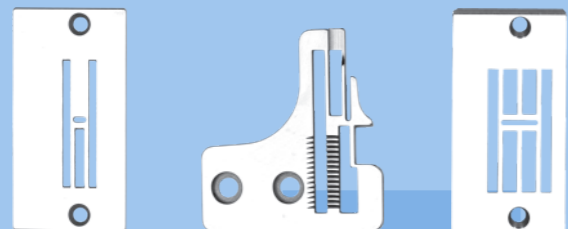

241372 10FE 164178 246-D 282188 457U

FOR HIGHLEAD/海菱

1-4 1-5 1-6

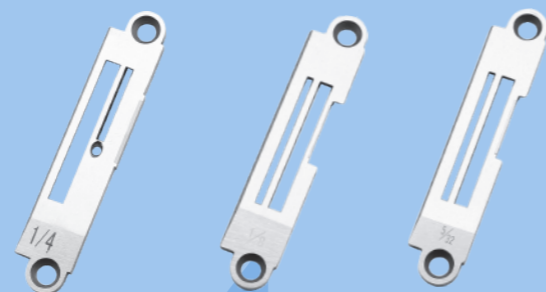

19S01-013G01 (1/4) 74H01-008G01 (1/8) 74H01-010G01 (5/32)

FOR UNION SPECIAL/友联

2-1 2-2 2-3 2-4

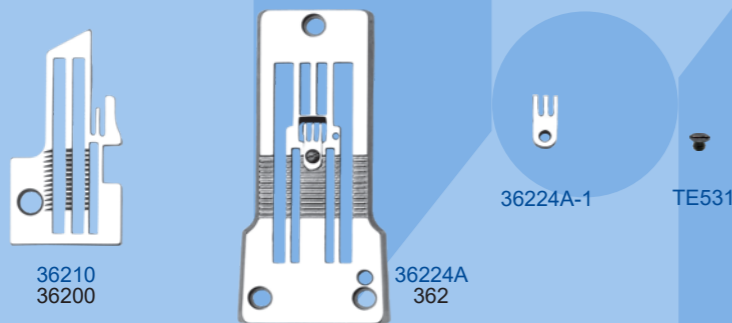

36210 36200 36224A 362 36224A-1 TE531

FOR VIBEMAC/威比玛

2-5

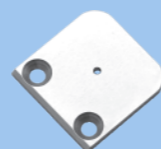

82115201 UAM04

FOR OTHERS/其他

3-1 3-2 3-3 3-4 3-5



520A007(3/16) 520A007(1/4) 520A007(9/32) 520A007(5/16) 520A007(7/32) NE501(1/8) NE502(1/4) NE503(3/16) NE534(5/16) NE557(3/8) NE498 DY-359(1/8) NE499 DY-359(1/4) NE500 DY-359(3/16) NE814 DY-359(1/16) NE828 DY-359(5/16) NE762

4-1 4-2 4-3 4-4 4-5

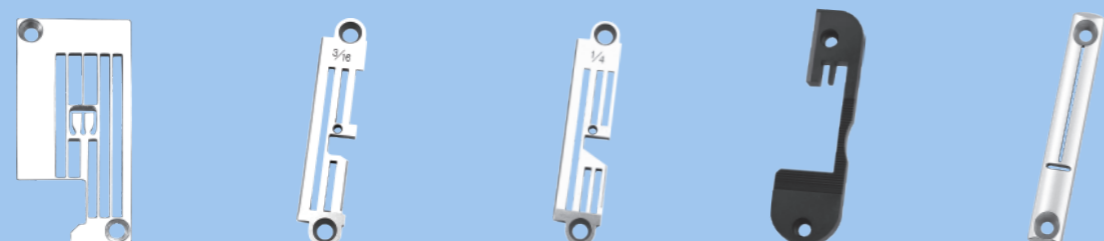

31015001 NE815 NE816 NE013(22) NE013(24) 131045701SP

工业缝纫机牙齿

FEED DOG FOR INDUSTRIAL SEWING MACHINES

INDUSTRIAL SEWING MACHINES SPARE PARTS



FOR BROTHER/兄弟

1-1 1-2

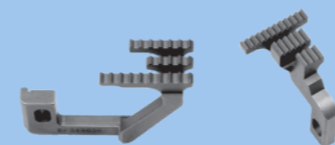

S49030-001 S49029-001

DT4-V61Z

FOR JUKI/重机

1-3 1-4 1-5

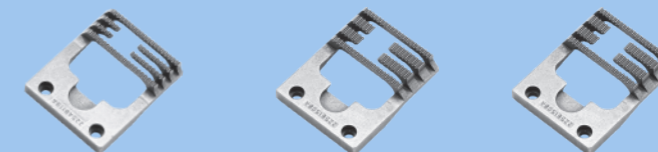

22548119A LZ-2280 22581508A LZ-2280 22581508S LZ-2280

2-1 2-2 2-3 2-4 2-5 2-6

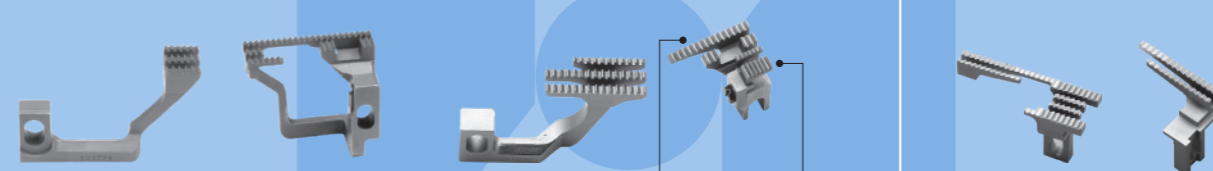

121-73407 121-70908 13193206 13192406 13191408 15-635 15-637

MO-3716-FF6-320-42H MO-6000 S6604GLR

3-1 3-2 3-3 3-4 3-5 3-6 3-7 3-8

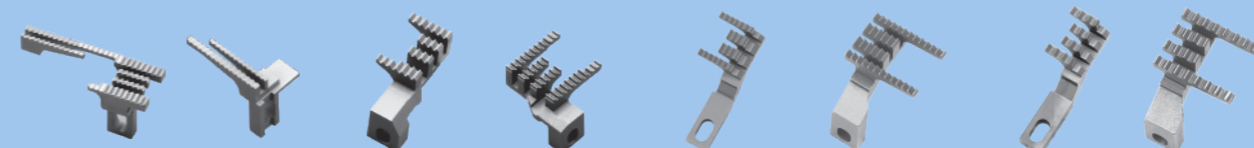

15-636 15-638 15-785 15-786 15-880 15-881 15-809 15-867

S6604GLR NC1104GCL RX9000DW/CLW RX9000AHD

4-1 4-2 4-3 4-4 4-5 4-6



15-853 15-854 15-860 15-859 15-862 15-861

RX-ALK/PLK RX-C(2x4.8) RX/C(2x5.6)(2x6.4)

FOR KANSAI SPECIAL/关西

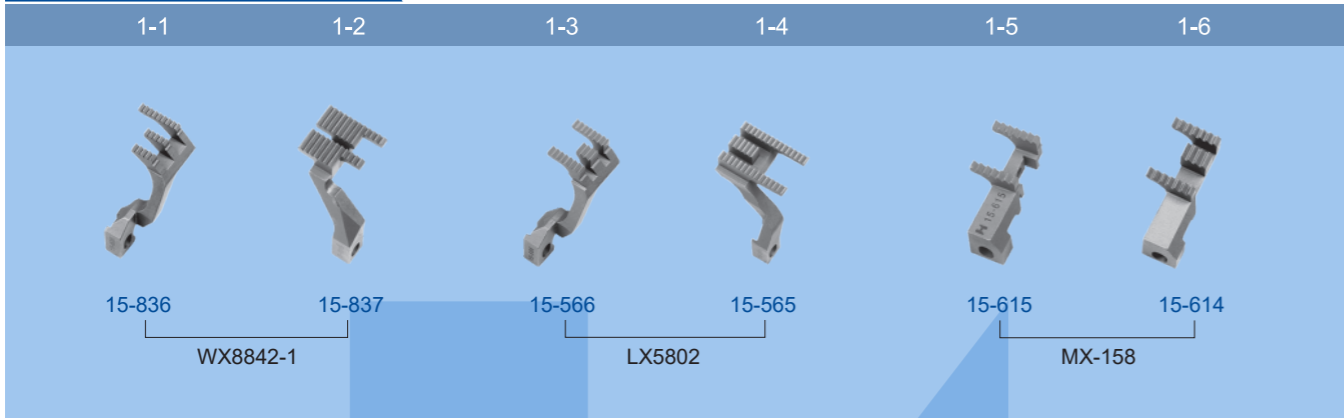

FOR SHING RAY/星锐

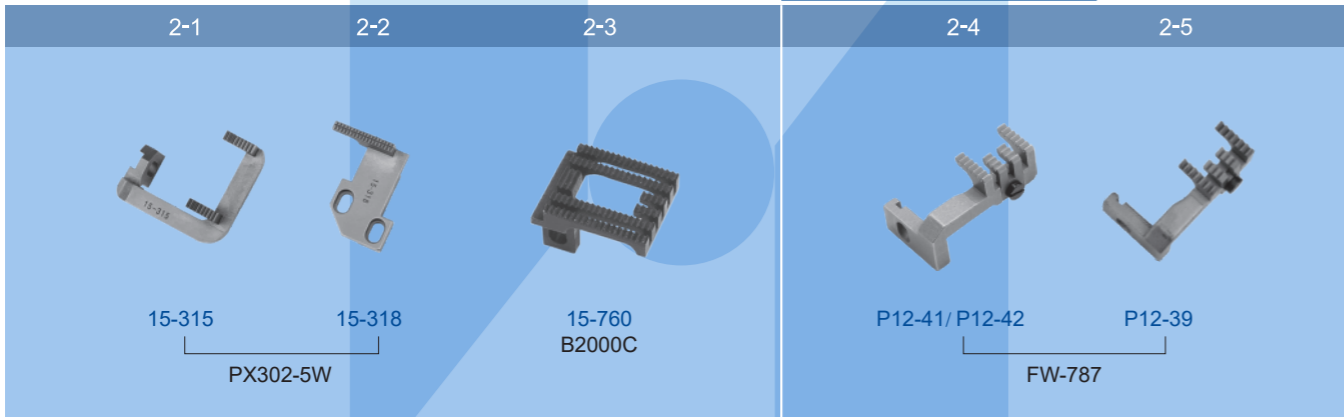

FOR PEGASUS/飞马

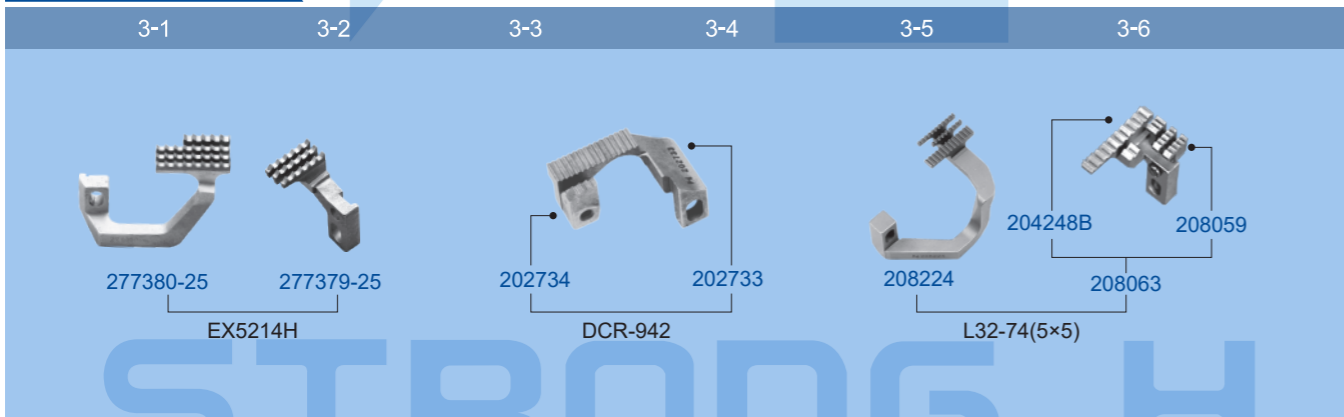

FOR SIRUBA/银箭

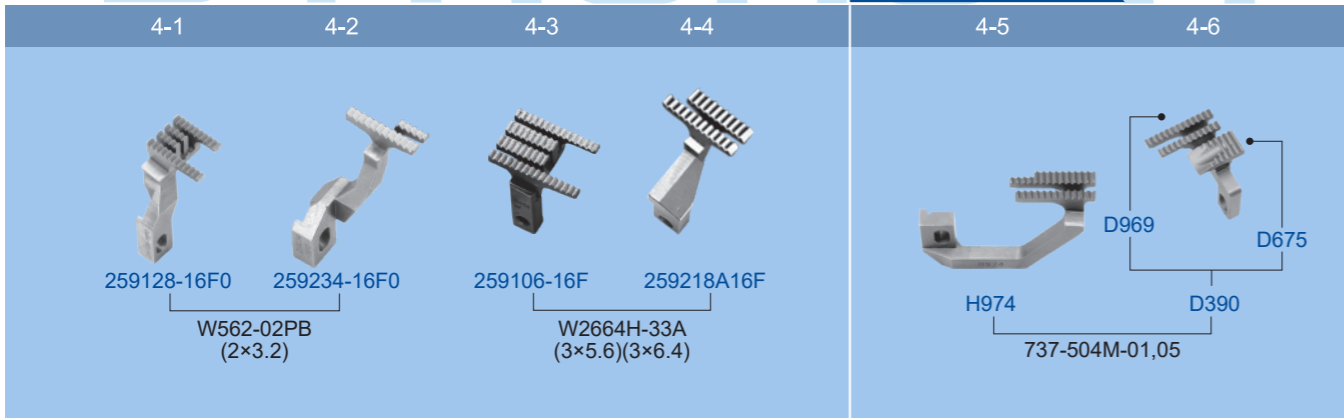

FOR SUN STAR/日星

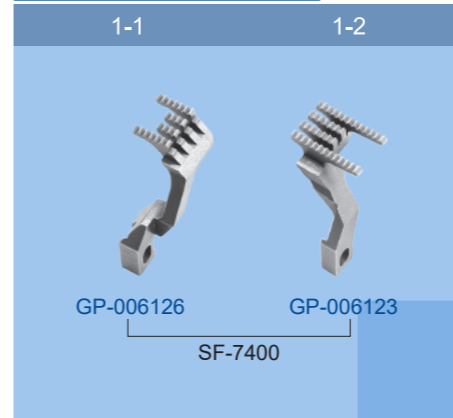

FOR YAMATO/大和

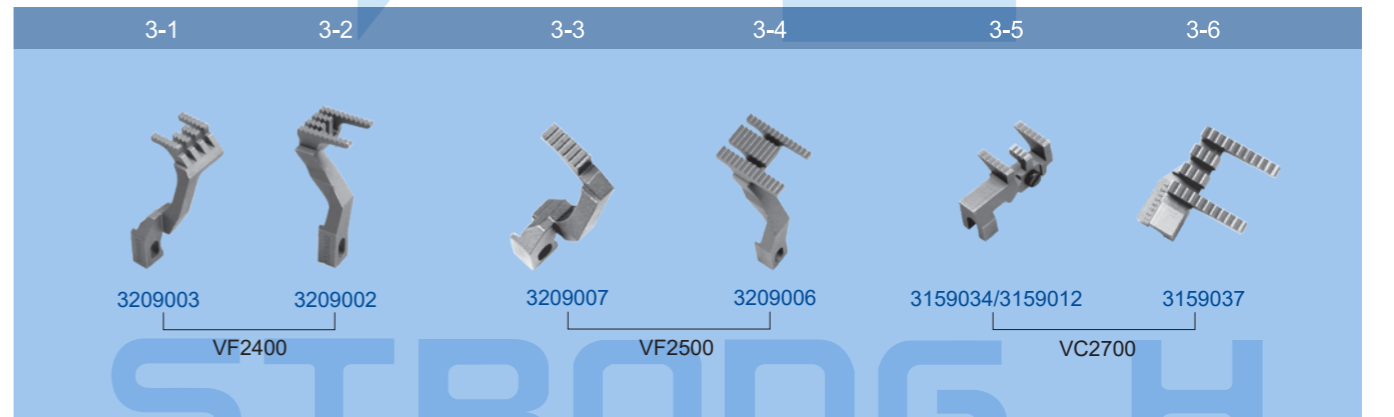
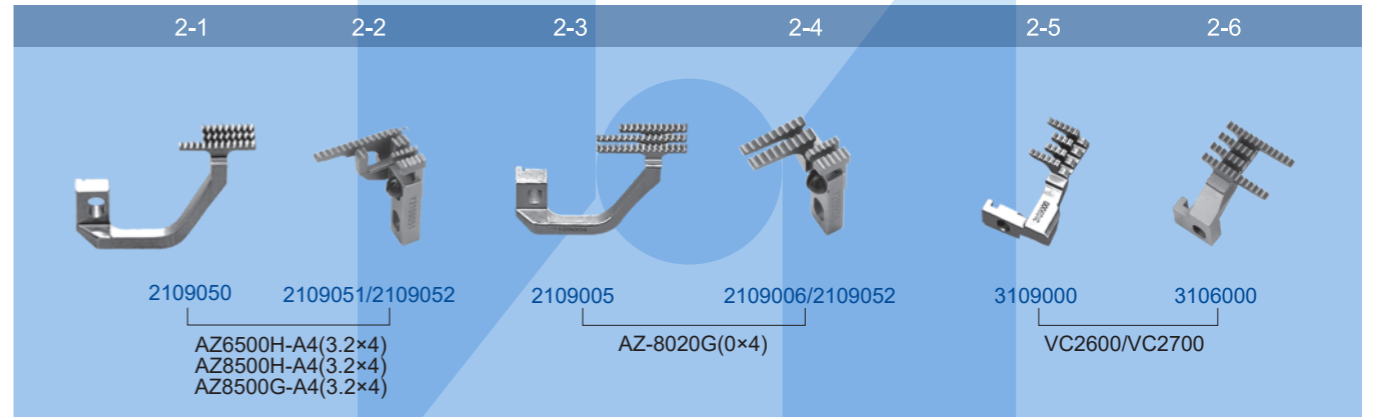
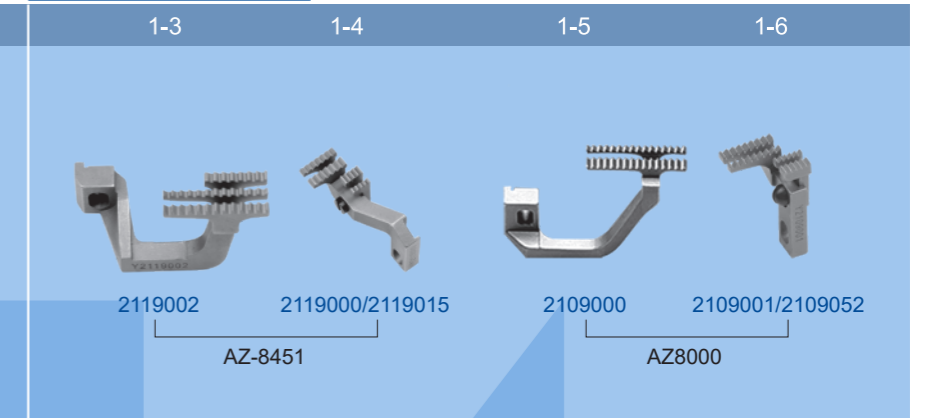

FOR OTHERS/其他

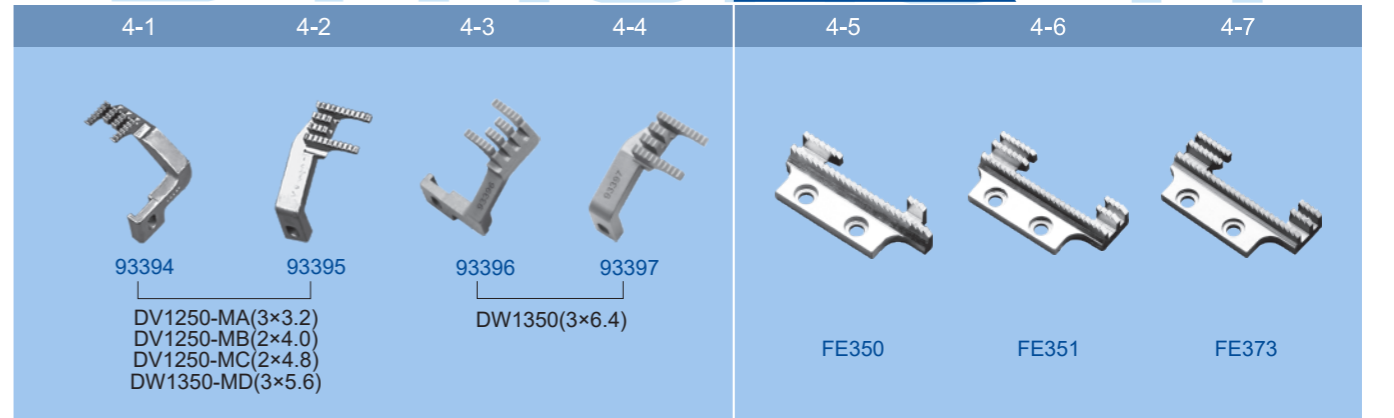



工业缝纫机压脚

PRESSER FOOT FOR INDUSTRIAL SEWING MACHINES

INDUSTRIAL SEWING MACHINES SPARE PARTS

FOR BROTHER/兄弟

1-1	1-2	1-3	1-4	1-5	1-6
S36566-001 S36566-001.D0.8 LT2-B875-UT LT2-B872-UT(2x1/4)	101491-101 DT6-B926 (2x3/16)	144629-001 LH4-B814-2 (25mm)	144497-001 LH4-B814-2 (25mm)	S00907-001 LK3-B43	S00906-001 LK3-B43

2-1	2-2	2-3	2-4	2-5	2-6
152777-001 KE-430F	152778-001 KE-430F	152780-001 KE-430F	152779-001 KE-430F	152781-001 KE-430F	152782-001 KE-430F

FOR KANSAI SPECIAL/关西

3-1	3-2	3-3	3-4	3-5
17-8770-1	17-3010-1 PX302-4W	17-3760-1 DVK1702BK (2x1/4)	17-9290-1(3x5.6) RX/PHK 17-9300-1(3x6.4)	17-9360-1 NR/ALK (3x7/32)

FOR JUKI/重机

4-1	4-2	4-3	4-4	4-5
126100800 MH-380(3x1/8)	118-76067 MO-2504-OA4-150 (0x1.6) MO-2504-OA4-150-FG (0x1.6)	118-81471 MO-2504-OD4-200 (0x3.2)	118-76364 MO-2504-OD6-300 (0x3.2)	118-77156 MO-2512-DD6-500 (3.2x3.2) MO-2512-DD6-600 (3.2x4.8)

工业缝纫机压脚

PRESSER FOOT FOR INDUSTRIAL SEWING MACHINES

INDUSTRIAL SEWING MACHINES SPARE PARTS



FOR JUKI/重机

1-1	1-2	1-3	1-4	1-5
118-77164 MO-2512-DD6-500 (3.2x3.2) MO-2512-DD6-600 (3.2x4.8)	118-79269 MO-2514-BO6-340 (2x3.2)	118-77578 MO-2516-DD4-300 (3.2x3.2) MO-2516-DF4-300 (3.2x4.8)	118-77768 MO-2516-FF6-500 (4.8x4.8)	118-78063 MO-2543-FBD6-300 (4.8x2.0x3.2) MO-6743-ID6-40H (4.8x2.0x3.2)

2-1	2-2	2-3	2-4
121-52451 MO-3914-BE6	121-52955 MO-3916-BE (2x3.2)	121-52963 MO-3916-BE (2x3.2)	12467205 MO-3700

3-1	3-2	3-3	3-4	3-5	3-6
135-18600	135-18709	135-72003	135-71906	135-48201	135-48102
135-18659 LK-1850(20x4.5)		135-71955 LK-1900 LK-1900A(5.6x23)		135-48151 LK-1900(27x5) LK-1900A(27x5)	

4-1	4-2	4-3	4-4
B1552-781-0A0-A LBH-781(30mm)	B1552-782-0A0-A LBH-782(40mm)	B1552-783-0A0-A LBH-783(46mm)	P570A/P569 BH790(30mm)



工业缝纫机压脚

PRESSER FOOT FOR INDUSTRIAL SEWING MACHINES

INDUSTRIAL SEWING MACHINES SPARE PARTS

FOR PEGASUS/飞马

1-1

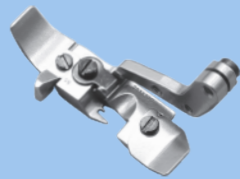

201230C
201310A
274018-92B
L52-11

1-2

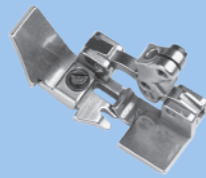

208506S
L32-86(5×6)

1-3

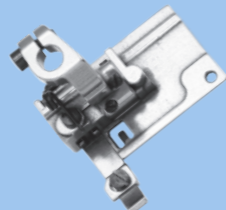

257350-32
W562-02HB(2×3.2)

1-4

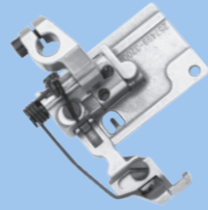

257499-3200
W562-02DB(2×3.2)

FOR SIRUBA/银箭

2-1

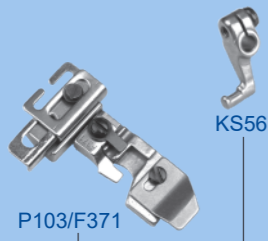

P103/F371
P103-3
737-504M2(0×4)

2-2



KS56

2-3

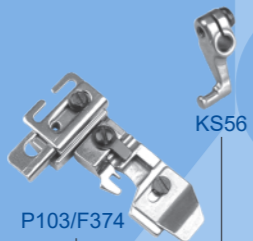

P103/F374
P103-4
747-514M2(2×4)

2-4



KS56

2-5

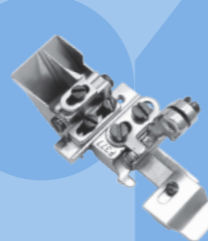

P212A-A
737KLF-D6

2-6



P212-5A
737KLF

2-7

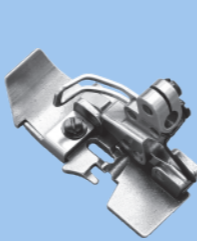

P964-A
700F

3-1

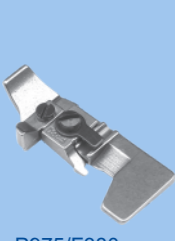

P975/F380
P975-3
M737-514M5(2×4)

3-2

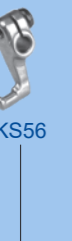

KS56

3-3



P975/F381
P975-4
M747-514M5(2×4)

3-4

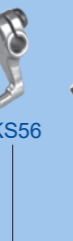

KS56

3-5

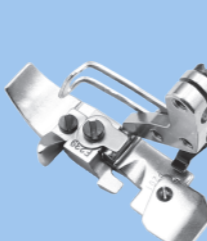

P201-4A
S700K

3-6

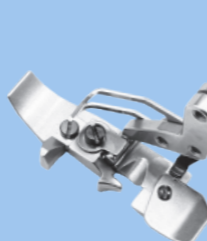

P201-A
S700K

3-7

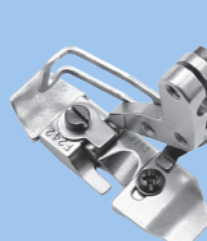

P203-A
737K

4-1

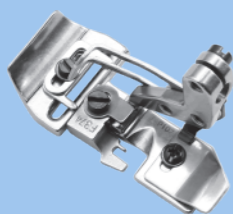

P217-4
S700K

4-2

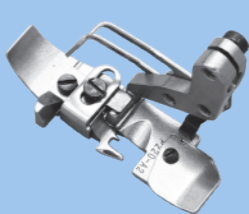

P220-A2

4-3

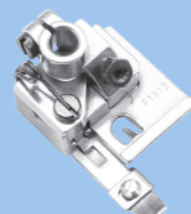

P1813-A
F700

4-4

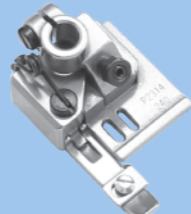

P2314-A
F7J-U222-24

4-5



P0314-A
C700E-U122

工业缝纫机压脚

PRESSER FOOT FOR INDUSTRIAL SEWING MACHINES

INDUSTRIAL SEWING MACHINES SPARE PARTS



FOR SIRUBA/银箭

1-1



P2315-A
F007J

1-2

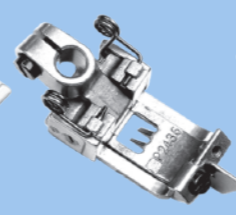

P2436-A
F007/C007K
(3×5.6)

1-3

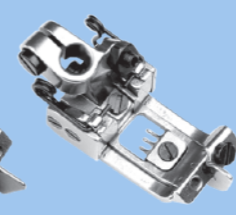

P2438Q-A
F007(4×6)

1-4

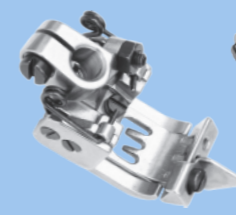

P2457-A
C007JD-W322/CC
(3×6.4)

1-5

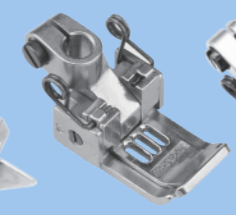

P0416-A
C007E-U122
/CH/UTQ
(2×5.6)(3×6.4)

1-6

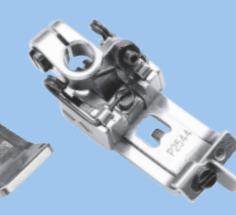

P2544-A
F007

2-1

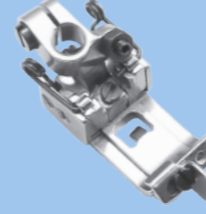

P2545-A
F007

2-2



P5232K-A
F007

2-3

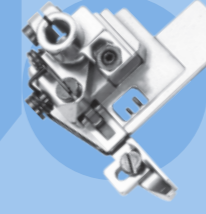

P3816R-A
P3817R-A
C007J-W522
(3×5.6)(3×6.4)

2-4

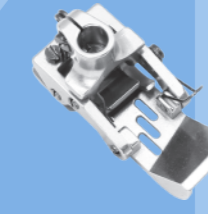

P8003-A
HF008

2-5



P8104-A

FOR YAMATO/大和

3-1

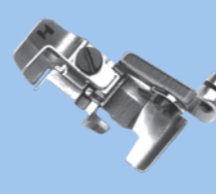

2157086
AZ6000H(0×4)
AZ8000G(0×4)

3-2

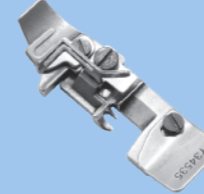

2107290/2107240
AZ8020H-Y5

3-3

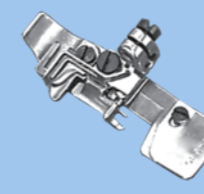

2107308
2107309
A28020H-Y5(2.4×5)
A28020H-Y6(2.4×6)

3-4



2157057
2157058
AZ8020G(2.4×5)(2.4×6)
AZ6020H(2.4×6)(2.4×6)

3-5

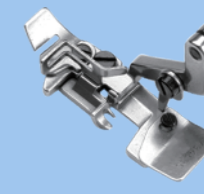

2157116
2157118
AZ8020G(2.4×5)(2.4×6)
AZ6020H(2.4×6)(2.4×6)

4-1

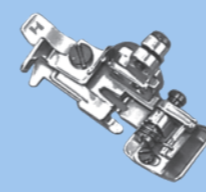

2107100
AZ8500H-A4
(3.2×4)

4-2



2107102
AZ8500H-C5
(5×5)

4-3

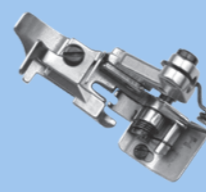

2157310
AZ8500G-A4(3.2×4)
AZ6500H-A4(3.2×4)

4-4

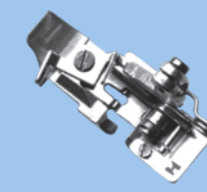

2157315
AZ8500G-C5(5×5)
AZ6500H-C5(5×5)

4-5

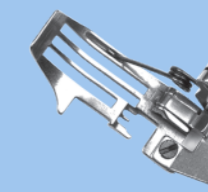

26135
ZF-125



工业缝纫机压脚

PRESSER FOOT FOR INDUSTRIAL SEWING MACHINES

INDUSTRIAL SEWING MACHINES SPARE PARTS

FOR YAMATO/大和

1-1	1-2	1-3	1-4	1-5
3027092 3027095 FD-62G-01MR(4×5.2) FD-62G-01MS(4×6.0)	3027140 3027143 FD-62G-12MR(4×5.2) FD-62G-12MS(4×6.0)	3027143.A FD-62G-12HS(4×6.0)	95580 95581 95582 VF2400-132M(3×3.2) VF2400-140M(2×4.0) VF2400-148M(2×4.8)	6507003 VT1500(3×5.6)

2-1	2-2	2-3
Z-91-136764-05	PE245.L	PE396.L

3-1	3-2	3-3
Z-91-136763-05	PE245.R	PE396.R

工业缝纫机针镙

NEEDLE CLAMP FOR INDUSTRIAL SEWING MACHINES

INDUSTRIAL SEWING MACHINES SPARE PARTS



FOR BROTHER/兄弟

1-1	1-2	1-3	1-4	1-5	1-6
146487-001 MA4-B551-061 (2×3) MA4-B551-062 (2×3)	S20404-001 MA4-N31-63-3(3×3) MA4-N31-63-4(3×4) MA4-N31-63-5(3×5)	181722-001 DT6-B928-6 (2×3/16) DT6-B928-8 (2×3/16)	S08709-001 FD4-B272-011-6 (3×4.8) FD4-B272-021-6 (3×4.8)	S08711-001 FD4-B272-011-7 (3×5.6) FD4-B272-021-7 (3×5.6)	S08713-001 FD4-B272-011-8 (3×6.4) FD4-B272-021-8 (3×6.4)

FOR JUKI/重机

2-1	2-2	2-3	2-4	2-5												
APW895	<table border="1"> <tr><td>400-46314</td><td>10mm</td></tr> <tr><td>400-46315</td><td>12mm</td></tr> <tr><td>400-46316</td><td>14mm</td></tr> <tr><td>400-46317</td><td>16mm</td></tr> <tr><td>400-46318</td><td>18mm</td></tr> <tr><td>400-46319</td><td>20mm</td></tr> </table>	400-46314	10mm	400-46315	12mm	400-46316	14mm	400-46317	16mm	400-46318	18mm	400-46319	20mm	118-69955 MO-2512 (3.2×3.2)	B1420-716-D00 MO-816	B1409-890-GA0 MF-890-GEM (3×5.6) B1409-890-HA0 MF-890HBM(3×6.4) MF-890HEM(3×6.4)
400-46314	10mm															
400-46315	12mm															
400-46316	14mm															
400-46317	16mm															
400-46318	18mm															
400-46319	20mm															

FOR KINGTEX/宝狮

3-1	3-2	3-3	3-4
NC603033 SH6002-032-M02 SH6003-032-M04 SH6043-033-M04	NC604022 SH6004-A32-M14 SH6004-A42-M14 SH6044-A33-M14	FC240 FC248 FW777 (2×4.0)(2×4.8)	FC356 FC364 FW777 (3×5.6)(3×6.4)

FOR SHING LING/星菱

FOR KANSAI SPECIAL/关西

4-1	4-2	4-3	4-4	4-5
12-2200-1 DVK1702(2×6.4)	12-8390-1 WX/DW(3×6.4) WX8800(2×5.6)	12-8010-1 V7003D-7/32"(3×5.6) V8003C-7/32"(3×5.6) V7003F-7/32"(3×5.6)	12-8020-1 V7003D-1/4"(3×5.6) V8003C-1/4"(3×5.6) V7003DE-1/4"(3×5.6)	12-8120-1 V7002D(2×4)



工业缝纫机针钳

NEEDLE CLAMP FOR INDUSTRIAL SEWING MACHINES

INDUSTRIAL SEWING MACHINES SPARE PARTS

FOR PEGASUS/飞马

1-1 1-2 1-3 1-4 1-5 1-6 1-7



209670 M752-180 (0×4)	208914 L32	277031-92 EX3244-03/333K (5×2×4)	257500-40 257500-48 W500(2×4.0) W600(2×4.8)	257501-56 257501-64 W500(3×5.6) W600(3×6.4)	257542-56 257542-64 W1612-32B(3×5.6) W1612-32B(3×6.4)	236631-56 FW603AF (3×5.6)
-----------------------------	---------------	--	--	--	--	---------------------------------

FOR PFAFF/百福

2-1 2-2 2-3 2-4



91-164727-X4	91-710004-04/002	91-710004-04/005	91-710004-04/006
--------------	------------------	------------------	------------------

FOR SIRUBA/银箭

3-1 3-2 3-3 3-4 3-5



M4232 F007-U22/FP (2×3.2)	M5232 F007-U22/FP (2×3.2)	M4348 C007-U322/CF (3×4.8)	M5348 C007-U322/CF (3×4.8)	KG231K-E 737K-504M1 737K-504M2 (0×3)(0×4)
---------------------------------	---------------------------------	----------------------------------	----------------------------------	--

4-1 4-2 4-3 4-4 4-5



KG242K-E 747K-512M1 747K-514M2 (2×4)	KG253K-E 757K(5×5)(5×6)	KG255K-E 757K-516M2(5×5)	KG433K-E 767K-516M2 (3×2×4)	KG455K-E 767K-516M2 (3×2×4)
---	----------------------------	-----------------------------	-----------------------------------	-----------------------------------



工业缝纫机针钳

NEEDLE CLAMP FOR INDUSTRIAL SEWING MACHINES

INDUSTRIAL SEWING MACHINES SPARE PARTS

FOR SUN STAR/日星

1-1 1-2 1-3 1-4 1-5



GP-031183-00 SC7300H-156M (3×5.6)	GP-006802-00 SC7200-148M(3×4.8) SC7210-148L(3×4.8)	GP-013516 SC7300(3×4.8)	GP-032603 SC7200H(2×3.2) GP-032604 SC7200H(2×4.0) GP-032605 SC7200H(2×4.8) GP-032606 SC7300H(2×6.4)	GP-030272
---	--	----------------------------	--	-----------

FOR YAMATO/大和

2-1 2-2 2-3 2-4 2-5



2109101 AZ8020H-Y5(2.4×5) AZ8020H-Y56(2.4×6)	2109102 AZ8020H-X4(2×4)	2109110 AZ8500H-A4 (3.2×4)	3109111 3109112 VC2700(3×5.6) VC2700(3×6.4)	3209100 VF2400-132M (2×3.2)
--	----------------------------	----------------------------------	--	-----------------------------------

3-1 3-2 3-3 3-4 3-5



3209106 VF2500-148M (3×4.8)	2109112 AZ8500H-C5 (5×5)	2109132 AZ6003H-03(0×3) AZ6000H-03(0×3) AZ6016H-02	2109120 AZ65000H-A4(3.2×4) AZ65000H-A5(3.2×5)	2109122 AZ6500H-C5(5×5) AZ6500H-C6(5×6)
-----------------------------------	--------------------------------	---	---	---

4-1 4-2 4-3 4-4 4-5 4-6



2159102 AZ6020H (2.4×5)(2.4×6) AZ8020G (2.4×5)(2.4×6)	2159111 AZ6500H-A4 (3.2×4) AZ8500G-A4 (3.2×4)	2159112 AZ6500H (5×5)	2169113 AZ7600G	93251 93252 93253 DV1250-MA(2×3.2) DV1250-MB(2×4.0) DV1250-MC(2×4.8)	93257 DV1350-MD (3×5.6)
---	---	-----------------------------	--------------------	---	-------------------------------

We always bringing you the BEST



Looper

for industrial sewing machines
工业缝纫机弯针





















2025-2026

Industrial sewing machine spare components
工业缝纫机零配件部分



强信机械科技
STRONG H MACHINERY TECHNOLOGY

FOR BROTHER/兄弟













	MA4-B551 (5 thread)	EF4-B511 (3 thread)	EF4-B531 (4 thread)	EF4-N11 (3 thread)	EF4-N21 (4 thread)
Upper looper 上弯针	1-1  147934-001 159686-001		1-2  147934-001 147936-001	1-3  S20422-001 S20424-001 S20426-001 S20428-001 S20438-001	1-4  S20424-001 S20430-001 S20432-001 S20434-001 S20436-001 S20438-001 S20440-001 S20442-001 S20444-001 S20445-001
Lower looper 下弯针	2-1  S01248-001 144049-001 159884-001	2-2  S01248-001	2-3  S01248-001 159884-001	2-4  S20626-001	2-5  S20627-001
Upper spreader 上散针	3-1  147935-001				
Chain looper 链条弯针	4-1  146635-001				
Looper guard 弯针护片	5-1  146726-001		5-2  146777-001	5-3  S39653-001	
	6-1  144127-001		6-2  144127-001	6-3  S20415-001	6-4  S18061-001
Chain Looper guard 链条弯针护片	Front 前				
	Rear 后				





















FOR BROTHER/兄弟

	EF4-N31/MA4-N31 (5 thread)	MA4-B693/694	EF4-V51/A	EF4-B671/B672	FD4-B272
Upper looper 上弯针	1-1 S20422-001 S20424-001 S20428-001 S20438-001	1-2 155240-001	1-3 S20424-001 S20436-001 S20430-001 S20438-001 S20432-001 S20440-001 S20434-001 S20442-001	1-4 155240-001	
Lower looper 下弯针	2-1 S20626-001 S20627-001	2-2 S01249-001 144049-001	2-3 S20627-001	2-4 159434-001	2-5 S08913-001
Upper spreader 上摆针	3-1 S20421-001 S20423-001 S20429-001	3-2 155241-001			3-3 S08934-001
Chain looper 链弯针	4-1 S20653-001	4-2 146635-001		4-3 146635-001	
Looper guard 弯针护片	5-1 S38306-501	5-2 146496-001		5-3 146726-001	
	6-1 S20415-001	6-2 158433-001	6-3 S20415-001		
	7-1 S38307-001				
Chain looper guard 链弯针护片	8-1 S20418-001				













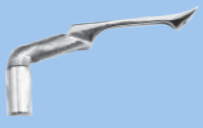





FOR BROTHER/兄弟

DT6-928-(1/8,7/64)			DT6-927(3/16")			DT6-927(1/8 5/32")
1-1 S40375-001 short	1-2 S40376-001 midium	1-3 S40377-001 long	1-4 S40391-001 short	1-5 S40392-001 long	1-6 S40389-001 S40390-005	
DT6-928/927(1/4")		DT6-B925(3/16")		DT6-B925(1/4")		
2-1 S40393-001 short	2-2 S40394-001 long	2-3 101492-001 short	2-4 101493-001 long	2-5 101558-001 short	2-6 101559-001 long	
DT6-B925(1/8")			DH4-B980/RH-9800			
3-1 105203-001 short	3-2 105204-001 long	3-3 SA6863-001	3-4 S35413-001 left fork spreader	3-5 S35411-001 left eye looper		
			3-6 S35410-001 right blind looper	3-7 S35412-001 right spreader		
DT6-962(1/4")		DT6-962(3/16")		DT6-926		
4-1 116230-001 short	4-2 115989-001 long	4-3 115988-001 short	4-4 115987-101 long	4-5 148869-001 short	4-6 148870-001 mdium	4-7 148871-001 long























557				
1-1  557000614 left fork spreader	1-2  557000605 left eye looper	1-3  557000602A right blind looper	1-4  557000611 right spreader	1-5  557002035 left eye looper
558/559/578/579/589				
2-1  557002872 left eye looper	2-2  557003398 left eye looper	2-3  558002876K left eye looper	2-4  557000602A right blind looper	2-5  557000611 right spreader
3-1  557002872 left eye looper	3-2  557003243 left eye looper	3-3  557002872A left eye looper		

	MO-2404	MO-2414	MO-2416	MOG-2400	MO-2504
上轴针 upper looper	1-1  118-88005 118-88104 119-99208	1-2  118-88104 1-3  119-99208	1-4  118-88005 118-88104 1-5  119-99208	1-6  120-14908 116-51908	1-7  118-88005 118-88104 118-88302
下轴针 lower looper	2-1  119-99307 119-99307/ZJ (Original quality)			2-2  119-99802	2-3  118-88401 118-88401/ZJ (Original quality)
脚踏针 upper spreader			3-1  120-03604	3-2  120-14809 120-14817	
链条轴针 chain looper			4-1  118-29405	4-2  120-03604	
轴针 looper guard	5-1  118-90100	5-2  118-90308			5-3  118-90100
	6-1  118-90001				
链条轴针 Chain Looper guard			7-1  120-15300		
			8-1  120-15400		

FOR JUKI/重机

		MO-2514	MO-2516	MO-3304	MO-3314	MO-3316
upper looper 上弯针	1-1	 118-88104 118-88203	1-2	 124-81107	1-4	 124-81008
			 118-88005 118-88104 118-88302			
lower looper 下弯针	2-1	 118-88401		2-2		 124-81800
upper spreader 上铺针			3-1			
			 116-93108			
chain looper 链弯针			4-1			4-2
			 118-29405			 124-82600
looper guard 弯针护板	Front 前	5-1		5-2	5-3	5-4
		 118-90308		 124-84101	 124-84200	 124-84408
	Rear(movable) 后(移动)	6-1	6-2			
		 118-90001		 124-84002		
Chain Looper guard 链弯针护板	Front 前		7-1			7-2
			 120-15301			 124-84507
	Rear 后		8-1			8-2
			 120-15400			 124-84606

FOR JUKI/重机













		MO-3604 MO-3904	MO-3614 MO-3914	MO-3616 MO-3916	MO-3714	MO-3716
upper looper 上弯针	1-1	 118-88104	1-3	 118-88104	1-6	1-7
		 119-99208	 121-76004 121-76103 121-76202	 119-99208	 121-76103	 119-91908 121-76202
lower looper 下弯针	2-1		 119-99307 119-99802		2-2	 119-99802
upper spreader 上铺针				3-1		3-2
				 116-93108		 118-88609
chain looper 链弯针				4-1		4-2
				 118-29405		 121-20705
looper guard 弯针护板	Front 前	5-1	5-2	5-3	5-4	5-5
		 118-90100	 118-90308	 121-77903	 118-90308	 121-77903
	Rear(movable) 后(移动)				6-1	
					 118-90001	
Chain Looper guard 链弯针护板	Front 前			7-1		7-2
				 120-15301		 120-15301
	Rear 后			8-1		8-2
				 120-15400		 120-15400

FOR JUKI/重机















	MOG-3700 MOJ-3900 MOG-6900	MO-6704S MO-6904S/R	MO-6714S MO-6914S/R	MO-6716S MO-6916S/R	MO-6904J MO-6914J MO-6916J
upper looper 上弯针	1-1 123-83501 123-83600 123-83808	1-2 118-88104	1-3 121-76004	1-4 118-88104	1-5 123-83501 123-83600
lower looper 下弯针	2-1 123-84202	2-2 	2-3 119-99307	2-3 123-84202	
upper spreader 上插针					
chain looper 链弯针	3-1 123-84400			3-2 121-20705	
looper guard 弯针护针	4-1 118-90100 118-90308	4-2 118-90100	4-3 118-90308		
	5-1 118-90001 123-84509	5-2 118-90001			
Chain Looper guard 护针	6-1 120-15301			6-2 120-15301	
	7-1 120-15400			7-2 120-15400	

FOR JUKI/重机





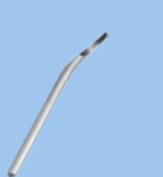









	MF-7700	MF-7800				
looper 弯针	1-1 133-37902	1-2 134-24809				
spreader 插针	2-1 133-29404					
looper guard 弯针护针	3-1 133-34602	3-2 134-20609				
	4-1 133-34701	4-2 134-20302				
MH-380		MH-3810	MS-1261(1/4")			
5-1 B2030-380-000 left	5-2 B2031-380-000 right	5-3 40115382	5-4 129-69101 middle	5-5 129-68509 front	5-6 129-68806 rear	
MS-1190(1/4")		MS-1190(3/16")				
6-1 129-40904 right	6-2 129-41803 right	6-3 129-40508 left	6-4 129-41407 right			

MEB-3200/2688					
1-1  320-39604					
MEB-3200/2688					
2-1  140-31116 #04 left fork spreader	2-2  400-15684 #07 left fork spreader	2-3  320-40917 #07 left fork spreader	2-4  140-30902 left eye looper	2-5  140-30803 right blind looper	2-6  140-31017 right spreader
MEB-3200JS			MB-372		MB-373
3-1  320-40917 left fork spreader	3-2  320-49800 left eye looper	3-3  400-15694 right blind looper	3-4  400-15695 right spreader	3-5  B1239-372-000	3-6  B1239-373-000

DPW1302		DLR-1501		DLR-1503	
4-1  19-353 front	4-2  19-351 rear	4-3  19-535	4-4  19-531	4-5  19-535	4-6  19-536
PX302		DLR-1504 (4 needle)		WX8800	
5-1  19-363 front	5-2  19-362 rear	5-3  19-546	5-4  19-837	5-5  19-838	5-6  New 19-486

DVK1702B/B200C		DLR-1508 1/4-3/4-1/4		DLR-1508 3/16-1/3-1/6	
1-1  19-712 looper		1-2  19-582 short	1-3  19-581 long	1-4  19-583 short	1-5  19-581 long
FBX1100		DLR-1508 1/4-1-1/4		DLR-1509	
2-1  19-287 looper	2-2  19-288 guard	2-3  19-582 short	2-4  19-581 long	2-5  19-592 short	2-6  19-593 long
FX4400			NB1425/33,DFB1400 (needle standard thread,looper elastic+standard thread)		
3-1  19-431 3.2mm 19-431A 2.5mm 19-431B 2.2mm 19-431N 2.7mm 19-431S 2.3mm			3-2  19-431 3.2mm 19-431A 2.5mm 19-431B 2.2mm 19-431N 2.7mm 19-431S 2.3mm		
4-1  19-404 retainer	4-2  19-405 guard	4-3  19-437 retainer	4-4  19-416 guard		













FOR KANSAI SPECIAL/关西

NB1425/33,DFB1400 (needle standard thread,looper elastic thread)		NB1425/33,DFB1400 (needle elastic thread)	
1-1	 19-432 3.2mm 19-432A 2.5mm 19-432B 2.2mm 19-432N 2.7mm 19-432S 2.3mm	1-2	 19-112 3.2mm 19-112A 2.5mm 19-112S 2.3mm
2-1	 19-439 retainer	2-2	 19-416 guard
		2-3	 19-416 guard
	W8000	WX8000	DX/RX-9800
3-1	 19-801	3-2	 19-539
		3-3	 19-525
4-1	 19-807	4-2	 19-505
		4-3	 19-505
5-1	 18-805	5-2	 18-551
6-1	 18-806		













FOR KANSAI SPECIAL/关西

UK10004S-01M 56-458	
1-1	 56-458



















FOR KINGTEX/宝狮

	SH7000 (3 thread)	SH7000 (4 thread)	SH6000(5 thread) SH6003	UH8000/9000	
2-1	 5212UL603880 5212UL603881	2-2	 5210UL604882 5210UL604883	2-3	 5212UL603880 5212UL603881
		2-4	 5212UL0002 5212UL0003		
3-1	 5212LL603884 5212LL604885	3-2	 5212LL603884	3-3	 5212LL0001 5212LL0002
4-1			 5212UL603886		
5-1			 CL605294		
	CT6500	FT6500	SH6000		
6-1	 LLC00560	6-2	 LLF00560	6-3	 LL81600

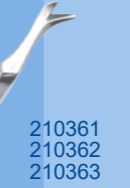
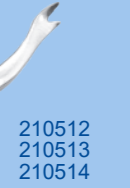
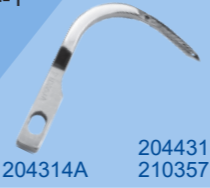

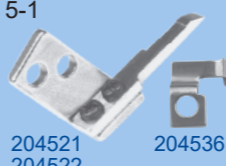













FOR PEGASUS/飞马

	R52(3 thread)	R52(4 thread)	R53(3 thread)	R53(4 thread)	R57(3 thread)
upper looper 上弯针	1-1  204062 204702 204703	1-2  204949 204963 204964 204663 204990 209209	1-3  202828 205891		1-4  202874 202842
lower looper 下弯针	2-1  204072 204991		2-2  202703 202408		2-3  202861
upper spreader 上摆针			3-1  202840		3-2  202840
chain looper 链弯针					
looper guard 弯针护板	4-1  204634 204635	4-2  204659			
	5-1  209009				





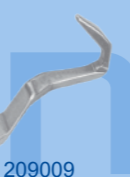















FOR PEGASUS/飞马

	R57(4 thread)	L32(5/6 thread)	E52(3 thread)	E52(4 thread)	E52(5/6 thread)
upper looper 上弯针	1-1  202842 202872 202874	1-2  204062 204702 204703 204963	1-3  210364 210365 210367 210368	1-4  211507 210358 210259 210729 210730 211507 211719 210368 210359	1-5  210364 210365 210367 211507 211719
lower looper 下弯针	2-1  202861	2-2  204072	2-3  210356 212215	2-4  210354 210356 212644	2-5  210356
upper spreader 上摆针	3-1  202840	3-2  204278 204704 204702		3-3  210361 210362 210363	3-4  210512 210513 210514
chain looper 链弯针		4-1  204314A 210357			4-2  210357
looper guard 弯针护板	5-1  204521 204522				
		6-1  209009			
Chain Looper guard 链弯针护板		7-1  204782			
		8-1  204781			















FOR PEGASUS/飞马

	M752(3 thread)	M752(4 thread)	M732(5/6 thread)	M852(3 thread)	M852(4 thread)
upper looper 上弯针	1-1  204062 210371	1-2  204949 204963 204990 209733000019 204949/ZJ 204963/ZJ (Original quality)	1-3  204062 204702 204703 (Original quality)	1-4  204062	1-5  204062 204963 209209
lower looper 下弯针	2-1  204072	2-2  204072 204991 (Original quality)	2-3  204072	2-4  204072 204991	
upper spreader 上摆针					
chain looper 链弯针			4-1  209685 209685AC0009		
looper guard 弯针护板	5-1  204659	5-2  204659	5-3  209668	5-4  204659	
	6-1  209009				
Chain Looper guard 链弯针护板			7-1  204536		
			8-1  209669		







FOR PEGASUS/飞马

	M832(5/6 thread)	EX52(3 thread)	EX52(4 thread)	EX32(5/6 thread)
upper looper 上弯针	1-1  204702 204703 209733000019 204703/ZJ (Original quality)	1-2  277010 277010A 277010B 277012 277036 277010/ZJ 277010A/ZJ (Original quality)	1-3  277010 277010A 277010B 277012 277019	1-4  277010 277010A 277010B 277011 277017
lower looper 下弯针	2-1  204072	2-2  277015 (Original quality)	2-3  277015 277015A 277016 277016A 277034 277034/ZJ (Original quality)	2-4  277015 277015A
upper spreader 上摆针				3-1  277014 277014A 277014B
chain looper 链弯针	4-1  209685 209685AC0009			4-2  277018 277018C (heavy)
looper guard 弯针护板	5-1  209668	5-2  277005		5-3  277007
	6-1  209009	6-2  277004		
Chain Looper guard 链弯针护板	7-1  204536 204042			7-2  277008
	8-1  209669 209669A			8-2  277006 277006/A







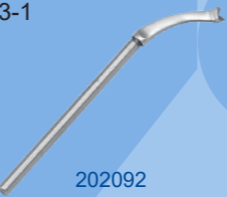

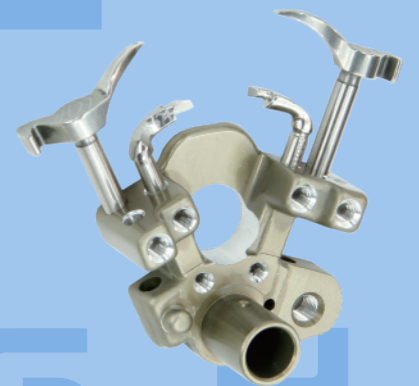

FOR PEGASUS/飞马

Interlock machines 绷缝机	Flat Bed W500/1500	Double Chainstitch W522-04	Cylinder Bed W600/W2600	Small Cylinder Bed M200
looper 弯针	1-1  257550 257550-91	1-2  257551D right 206097C 206097D left	1-3  257566	257566/ZJ (Original quality)
spreader 挑针	2-1  257565 257565A 257565D0 257552	2-2  257565	2-3  257565 257565C0	2-4  257565
looper guard 护针	3-1  257551 257551A 257551B		3-2  257568	
	4-1  257553		4-2  257567	
	FS-601			
looper 弯针	5-1  236500 236500/ZJ (Original quality)			
looper guard 护针	STRONG H			
thread carrier 勾线	7-1  236609 236609/ZJ (Original quality)			
thread hook 倒线	8-1  236610			

FOR RIMOLDI/利满地

	327(3 thread)	527(3 thread)	627(3 thread)	327(4 thread)	B27(4 thread)
upper looper 上弯针	1-1  204022 204033 206513	1-2  206512	1-3  209249	1-4  204021 206280	
lower looper 下弯针	2-1  202094 202413	2-2  202094 202095	2-3  209265 209266 209267	2-4  202094 202095 202413	2-5  270-075
upper spreader 上挑针		3-1  202092		3-2  202091 202092	

FOR RIMOLDI/利满地

	329/529(5 thread) 329/529-00-2CD/2MD	529(5 thread) 529-00-2MD	629(5 thread) 629-00-2CD/2MD	S101
upper looper 上弯针	4-1  204033 206512	4-2  206512	4-3  209248	
lower looper 下弯针	5-1  202413		5-2  209264	
upper spreader 上挑针	6-1  202092			
chain looper 送链弯针			7-1  209310	6-2  10-4009(D9) left fork spreader
				6-3  10-4005(D5) left eye looper
				7-2  10-4007(D7) right blind looper
				7-3  10-4004(D4) right spreader

FOR SIRUBA/银箭

		700(3 thread) 737F/FS/H/HD	700(4 thread) 747F/FS/H/HD	700(5 thread) 757F/FS/H/HD	700(3 thread) 737K	700(4 thread) 747K
upper looper 上弯针	1-1					
	2-1					
lower looper 下弯针	3-1					
upper spreader 上摆针	4-1					
chain looper 链弯针	5-1					
looper guard 弯针护片	6-1					
	6-2					
Chain Looper guard 链弯针护片	7-1					
	8-1					

FOR SIRUBA/银箭

		700(5 thread) 757K	F007	C007		
upper looper 上弯针	1-1					
	2-1					
lower looper 下弯针	3-1		looper guard 弯针护片			
upper spreader 上摆针	3-2					
chain looper 链弯针	4-1		HF008-02 1/4"		HF008-0464 1/4-1-1/4	
	5-1					
looper guard 弯针护片	6-1		HF008-03 1/4"			
	7-1					



FOR SIRUBA/银箭

VC008-13/17/23		VC008-13/17/23	
1-1  VE51 VE51T looper	1-2  VE30Q retainer	1-3  VE51P looper	1-4  VE30Q retainer
	2-1  VE49 guard		2-2  VE49 guard
VC008-12/VPQ (elastic thread)		VC008-12/VSQ (elastic thread shirring)	
3-1  VE51Q looper	3-2  VE30Q retainer	3-3  VSM47 looper	3-4  VE30Q retainer
	4-1  VE49 guard		4-2  VE49 guard











FOR SINGER/胜家

299U123/210/230		300U/300W		
5-1  548205 left fork spreader	5-2  548232 left eye looper	5-3  268370	5-4  268380	5-5  268382
6-1  548231 right blind looper	6-2  548207 right spreader			









FOR SHING RAY/星锐

1-1  07400843	1-2  07148870
--	--









FOR YAMATO/大和

	AZ6000H(3 thread) AZ6000H/15H/16H /17H/51H	AZ6000H(3 thread) AZ6003H-03 AZ-8003H-54	AZ6000H(4 thread) AZ6020H AZ-8046H-54	AZ6000H(4 thread) AZ6021H	AZ6000H(4 thread) AZ6025H/46H/98H
upper looper 上脚针	2-1  2109320	2-2  2109320 2109324 2109324/ZJ (Original quality)	2-3  2109322 2109326 2109322/ZJ (Original quality)	2-4  2109341	2-5  2109322 2109322/ZJ (Original quality)
lower looper 下脚针	3-1  2109300	3-2  2109300 2109331	3-3  2109300		
upper spreader 上脚叉					
chain looper 链条脚针					
looper guard 脚针护板	Front 前	4-1  2109200			
	Rear(movable) 后(可移动)	5-1  2109201			



















FOR YAMATO/大和

		AZ6000H(4 thread) AZ6032H/35H	AZ6000H(4 thread) AZ6045H	AZ6000H(5 thread) AZ6500G	AZ6500H	AZ7000G(3 thread) AZ7000G/03G/16G
upper looper 上弯针	1-1	 2109342	 2109320 2109320/ZJ (Original quality)	 2109301	 2109320	 2109320/ZJ (Original quality)
	2-1	 2109331	 2109300 2109300/ZJ (Original quality)	 2109347		
lower looper 下弯针						
upper spreader 上摆针						
chain looper 链弯针			3-1		 2109302	
looper guard 弯针护板	Front 前	4-1		4-2		4-3
	Rear(movable) 后(移动)	5-1		5-2		
Chain Looper guard 护针	Front 前			6-1		
	Rear 后			7-1		













FOR YAMATO/大和

		AZ7000G(4 thread) AZ7020G/25H AZ7120G/25G	AZ7000G(5 thread) AZ7600G	AZ8000G(3 thread) AZ8000G/03G/16G	AZ8000G(4 thread) AZ8020G/25G/120G	AZ8000G(4 thread) AZ8022G
upper looper 上弯针	1-1	 2109320 2109320/ZJ (Original quality)	 2109343	 2109320 2109320/ZJ (Original quality)	 2109322 2109322/ZJ (Original quality)	 2109341
	2-1	 2109347	 2109334	 2109347		
lower looper 下弯针						
upper spreader 上摆针						
chain looper 链弯针						
looper guard 弯针护板	Front 前	3-1		3-2		3-3
	Rear(movable) 后(移动)	4-1		4-2		4-3
Chain Looper guard 护针	Front 前			5-1		
	Rear 后					











FOR YAMATO/大和

	AZ8400	AZ8000H(5 thread) AZ8500H	AZ8600H	AZF8600	CZ6000H(3 thread) CZ6000/03/16
upper looper 上弯针	1-1  2119320 2119321 2119322 2119323	1-2  2109320 2109322 2109320/ZJ 2109322/ZJ (Original quality)	1-3  2109343		1-4  6209302
lower looper 下弯针	2-1  2119324	2-2  2109300	2-3  2109334		2-4  6209301
upper spreader 上摆针		3-1  2109328	3-2  2109335		
chain looper 链弯针		4-1  2109302			
looper guard 弯针护片	Front 前	5-1  2109211	5-2  2109211 2109214		5-3  6209200
	Rear(movable) 后(移动)	6-1  2109201			6-2  6209201
Chain Looper guard 链弯针护片	Front 前	7-1  2109212			
	Rear 后	8-1  2109210			









FOR YAMATO/大和

	CZ6000(4 thread) CZ6020/25/120/125	CZ6000(4 thread) CZ6120/125	CZ6000(5 thread) CZ6500	DCZ6000(3 thread)	DCZ6000(3 thread) DCZ200/1/2/3
upper looper 上弯针	1-1  6209300 6209300/ZJ (Original quality)	1-2  6209304	1-3  6209304 6209310		1-4  32807 34614 34615 34617 34618
lower looper 下弯针	2-1 	2-2  6209301 6209301/ZJ (Original quality)		2-2  New 2159305	2-3  34616 34619 34392
upper spreader 上摆针					
chain looper 链弯针			3-1  6209303		
looper guard 弯针护片	Front 前	4-1  6209200	4-2  6209203		4-3 32655
	Rear(movable) 后(移动)	5-1  6209201			
Chain Looper guard 链弯针护片	Front 前				
	Rear 后				













FOR YAMATO/大和

	DCZ7000(3 thread) DCZ700/3/11/15	DCZ200(4 thread) DCZ220/W/221/45/46/92	DCZ500(4 thread) DCZ520/W/221/45/46/53/54	DCZ700(4 thread) DCZ720/W/221/45/46
upper looper 上弯针	1-1  36180	1-2  32810 32811	1-3  34519 34584 34730 34749 34617 34618	1-4  36180 36621
lower looper 下弯针	2-1  34392	2-2  34393	2-3  34392 34393	2-4  34392 34393
upper spreader 上摆针				
chain looper 链缝弯针				
looper guard 弯针护板	5-1  34544	5-2  32359 32656 34584		
Chain Looper guard 链缝弯针护板	Front 前			
	Rear 后			

FOR YAMATO/大和

	DCZ300(5 thread) DCZ361/2/5/6/7/8/9/76/77	DCZ300(5 thread) DCZ341/342	DCZ361	E600
upper looper 上弯针	1-1  32807 32813	1-2  35253		1-3  21700
lower looper 下弯针	2-1  34392		2-2  New 35254	2-3  21754
upper spreader 上摆针	3-1  32813 35287			
chain looper 链缝弯针	4-1  33059			
looper guard 弯针护板	5-1  33089			
Chain Looper guard 链缝弯针护板	Front 前			
	Rear 后			

FOR YAMATO/大和

		Flat Bed DW/100/DV1266	Flat Bed DW/1300			FD-62G	
Looper 弯针	1-1	 90529 94480	1-2	 94480	Looper 弯针	1-3	 68217 68217/ZJ (Original quality)
	2-1	 90425				2-2	 68218
Looper guard 护针	Front 前				Looper guard 护针	3-2	 68123
	Rear(movable) 后/移动	3-1	 95723			4-3	 68124
		Flat Bed VT1500	Flat Bed VT2500				
Looper 弯针	4-1	 4309300 6509300	4-2	 4309320			
	5-1	 6109305					
Looper guard 护针	Front 前	6-1	 4309201				
	Rear(movable) 后/移动	7-1	 4309200				

FOR YAMATO/大和

		Flat Bed DW/1600	Flat Bed VF2300M/2400/2500			Flat Bed VG3721/2700 VC2600/2700	
Looper 弯针	1-1	 63178	1-2	 94480 3209311 3209312	Looper 弯针	1-3	 3109300 3109302 3109306
	2-1	 63059	2-2	 3109310 3509320			
Looper guard 护针	Front 前		3-1	 93659		3-2	 3109200 3139200
	Rear(movable) 后/移动		4-1	 95723		4-2	 3109201 3109210

品号 PART NO.	页数 PAGE	行数 LINE
0		
004539.00	P39	4-4
004540.00	P39	4-5
018260-832	P78	2-1
0195010127	P7	2-6
021020-106	P78	2-1
021670102	P101	6-1
0219003963	P7	2-7
025010132	P79	1-1
025030-236	P75	1-1
025030-236	P75	1-1
025030-236	P76	1-1
025030236	P76	2-1
025030236	P76	2-1
025030236	P77	1-1
025030236	P77	1-1
025030236	P77	1-1
025030236	P77	2-1
025030236	P77	2-1
025032-236	P76	1-1
0252052-141-C	P35	1-5
0252072-145-B	P35	1-4
026300-512	P78	2-1
0271001483	P7	4-3
0272007042	P7	4-1
0272007045	P7	4-2
028030-246	P75	1-1
028030-246	P76	1-1
028030246	P76	2-1
028030246	P76	2-1
028030246	P77	1-1
028030246	P77	1-1
028030246	P77	1-1
028030246	P77	2-1
0281 170210	P7	4-7
0281 350300	P7	4-5
0281 350300	P52	1-4
0281 350300	P52	2-1
0281 350310	P7	4-6
0281 350310	P52	1-5
0281 350310	P52	2-2
0281350300/ZF	P52	3-1
0281350310/ZF	P52	3-2
03-012	P40	1-5
030-0095-00	P6	1-5
030-0095-00.SH	P6	1-5
030-0096-00	P6	1-6
030-0096-00.SH	P6	1-6
030-0097-00	P6	2-1
030-0097-00.SH	P6	2-1
030-0098-00	P6	2-2
030-0098-00.SH	P6	2-2
030-0461-00	P6	2-5
030-0461-00.SH	P6	2-5
030-0461-01[T]	P6	2-6
030-1310-11	P6	2-3
030-1311-11	P6	2-4
0367 330780	P8	1-7
0367 350050	P8	1-4
0367 350060	P8	1-5
0367 350070	P8	1-3
0367 355050	P8	1-6
0367210240	P8	2-1
04007SC-5030	P87	2-1
04204FC	P42	4-3

品号 PART NO.	页数 PAGE	行数 LINE
04214FB-60	P42	4-4
0477 330240	P8	3-6
05-429	P22	2-7
05-447	P22	3-1
05-548	P22	2-6
05-549	P22	3-2
05-658	P22	1-4
05-812	P22	1-5
05-878	P22	1-3
0580 330040	P46	4-1
0580 330050	P46	4-1
0580 330060	P46	4-1
0580 330070	P46	4-1
0580 330080	P46	4-1
0580 330090	P46	4-1
0580 330100	P46	4-1
0580 330110	P46	4-1
0580 330120	P46	4-1
0580 330130	P46	4-1
0580 330140	P46	4-1
0580 330150	P46	4-1
0580 330380	P46	2-5
0580 330390	P46	2-4
06-351	P22	1-6
06-632	P22	1-7
060630312	P78	1-1
061300-416	P78	2-1
062020-416	P78	2-1
062300416	P75	1-1
062300416	P76	1-1
062300416	P76	1-1
062300416	P76	2-1
062300416	P76	2-1
062300416	P76	2-1
062300416	P77	1-1
062300416	P77	1-1
062300416	P77	2-1
062300416	P77	2-1
062670712	P74	1-1
062671012	P101	6-1
0667 175020	P8	2-5
0667 355110	P8	2-2
0667 355130	P8	2-3
0667 355140	P8	2-4
07-124	P21	4-1
07-125	P21	1-1
07-168	P21	4-3
07-169	P21	1-2
07-170	P22	1-2
07-206	P21	1-3
07-406	P21	4-2
07-432	P21	1-4
07-505	P22	1-1
07-507	P21	1-5
07-522	P21	1-6
07-529	P21	1-7
07-544	P21	4-5
07-545	P21	4-6
07-558	P21	3-1
07-570	P21	4-4
07-596	P21	3-2
07-597	P21	4-7
07-621	P21	2-3
07-626	P21	2-2

品号 PART NO.	页数 PAGE	行数 LINE
07-627	P21	2-1
07-631	P21	2-6
07-634	P21	2-5
07-638	P21	2-4
07-702	P21	3-6
07-703	P21	3-7
07-707	P21	3-5
07148870	P222	1-2
07400843	P222	1-1
0745331020	P7	1-4
0745331030	P7	1-3
0745339100(02)	P6	4-1
0745339110	P6	4-2
0745339110.SH	P6	4-2
0745339120(01)	P6	4-3
0745339120(01).SH	P6	4-3
0745339130	P6	4-4
0745339130.SH	P6	4-4
0745339320	P6	4-5
0745339320.SH	P6	4-5
0745339330	P6	4-6
0767 350380	P8	2-6
0767 350570	P8	3-1
0767 350580	P8	2-7
08-005	P22	2-3
08-055	P22	3-3
08-056	P22	3-4
081008-070	P74	2-1
0868354010	P8	3-3
0868354030	P8	3-2
0868354140	P8	3-4
0887330100	P8	3-5
1		
1-11(3mm)	P40	2-2
1-121-116	P38	4-1
1-121-117	P38	4-2
1-8(5mm)	P40	2-3
1-8A(3mm)	P40	2-1
10-001A-120H	P33	1-2
10-001A-2700	P32	4-2
10-001A-64L7	P32	4-5
10-002A-7507	P32	4-7
10-002A-8677	P33	1-8
10-005A-2700	P32	4-3
10-006A-120H	P33	1-1
10-006A-235B	P32	4-1
10-007A-7507	P32	4-6
10-008A-64L7	P32	4-4
10-011A-8677	P33	1-7
10-023.A	P129	1-2
10-0250-0	P128	3-1
10-0300-0	P129	3-1
10-051W-120H	P87	2-1
10-052W-120H	P87	2-1
10-054W-120H	P87	2-1
10-101A-2700	P32	3-6
10-1069-0-001	P47	4-2
10-1069-0-002	P47	4-2
10-1069-0-003	P47	4-2
10-1069-0-004	P47	4-2
10-1069-0-005	P47	4-2
10-1069-0-006	P47	4-2
10-1069-0-007	P47	4-2

品号 PART NO.	页数 PAGE	行数 LINE
10-1069-0-051	P47	3-1
10-1069-0-052	P47	3-1
10-1069-0-054	P47	3-1
10-1069-0-055	P47	3-1
10-1069-0-056	P47	3-1
10-1069-0-060	P47	3-1
10-106A-2700	P32	3-5
10-1197-1	P33	4-8
10-3072-0-014	P47	2-1
10-3072-0-014/M	P47	2-1
10-3072-0-024	P47	1-3
10-3072-0-024/M	P47	1-3
10-4004(D4)	P218	7-3
10-4005(D5)	P218	6-3
10-4007(D7)	P218	7-2
10-4009(D9)	P218	6-2
100-01709	P14	1-3
100105005	P74	1-1
100360003	P74	2-1
100360003	P75	1-1
100360003	P75	2-1
100360003	P76	1-1
100360003	P76	2-1
100360003	P77	1-1
100360003	P77	2-1
101.1-8	P40	1-8
101491-101	P191	1-2
101492-001	P202	2-3
101493-001	P202	2-4
101558-001	P202	2-5
101559-001	P202	2-6
101TE	P19	4-5
102-11118	P16	4-4
102-11209	P16	4-3
102-32403	P16	4-2
10211605	P16	3-7
103-002	P40	4-5
103-019	P40	4-4
1039895	P44	1-2
1039896	P44	1-3
1039999	P44	1-4
104336003	P78	1-1
10502300	P11	3-8
10502300.A	P11	3-8
105203-001	P202	3-1
105204-001	P202	3-2
105306-101	P6	1-4
106053	P39	1-5
106053.5A	P39	1-5
106083	P39	1-6
106083.5A	P39	1-6
106083.CT	P39	1-6
106160-101	P101	3-2
106629002	P79	1-1
107-26305	P16	1-6
107-26404	P16	1-7
10E	P69	1-1
10E(TFL)	P69	3-1
10EW	P70	1-1
10EW(KO)	P70	1-1
10KM	P69	2-1
10KMM	P70	2-1
10RAS261	P20	1-7

品号 PART NO.	页数 PAGE	行数 LINE
10S040S-306H	P87	2-1
10S042S-306H	P87	2-1
10S045S-306H	P33	1-4
10S045S-306H	P87	2-1
10S046S-306H	P87	2-1
10S047S-306H	P33	1-3
10S047S-306H	P87	2-1
10S048S-306H	P87	2-1
10S053S-306H	P87	2-1
10S056S-306H	P87	2-1
10S057S-306H	P87	2-1
10S058S-306H	P87	2-1
10S060S-306H	P87	2-1
11 1/2E	P69	1-1
11 1/2KM	P69	2-1
11-888302	P205	1-2
110-40052	P12	2-5
110-40052/M	P12	2-5
110-40201	P12	3-2
110-42652	P13	4-2
110-93259	P12	2-6
110-95403	P12	4-3
110023	P88	1-1
110023	P88	1-1
110034	P88	1-1
110054	P88	1-1
110215002	P79	1-1
110215002	P79	1-1
111-150-000	P47	1-2
111-151-000	P47	1-2
111-152-000	P47	1-2
111-153-000	P47	1-2
111-154-000	P47	1-2
111-155-000	P47	1-2
111-156-000	P47	1-2
111140002	P74	2-1
111140002	P75	2-1
111140002	P101	6-1
112319002	P17	4-1
112436-001	P2	1-1
112603-001	P92	1-2
112603-001	P93	1-1
112604-001	P92	1-2
112604-001	P93	1-1
112638-001	P92	3-2
112638-001	P93	3-1
112638-001	P95	3-1
112638-001	P95	3-4
112638-001	P96	3-1
112642-001	P92	3-2
112642-001	P93	3-1
112642-001	P95	3-1
112642-001	P95	3-4
112642-001	P96	3-1
112645-001	P93	3-2
112645-001	P96	3-2
112659-001	P93	2-1
112659-001	P95	2-5
112659-001	P98	2-5
112660-001	P93	2-1
112660-001	P95	2-5
112660-001	P98	2-5
112661-001	P93	2-2

品号 PART NO.	页数 PAGE	行数 LINE
112661-001	P96	2-2
112661-001	P98	2-5
112819004	P18	3-3
113-043-000	P47	1-1
113-13053	P12	4-7
113-51400	P12	2-1
113-51509	P12	2-2
113119001	P17	1-3
11312003	P17	1-5
11319002	P17	1-2
11319003	P17	1-2
113813029	P17	1-6
113819005	P17	1-7
114-023-000	P41	2-5
114-09257	P12	3-5
114-09257/M	P12	3-5
114-09604	P12	4-1
114-09604/M	P12	4-1
114119002	P17	1-1
114948-001	P92	3-1
114948-001	P92	3-3
114948-001		



索引表
PARTS LIST

INDUSTRIAL SEWING MACHINE SPARE PARTS

索引表
PARTS LIST

INDUSTRIAL SEWING MACHINE SPARE PARTS



品号 PART NO.	页数 PAGE	行数 LINE	品号 PART NO.	页数 PAGE	行数 LINE	品号 PART NO.	页数 PAGE	行数 LINE	品号 PART NO.	页数 PAGE	行数 LINE	品号 PART NO.	页数 PAGE	行数 LINE	品号 PART NO.	页数 PAGE	行数 LINE	品号 PART NO.	页数 PAGE	行数 LINE	品号 PART NO.	页数 PAGE	行数 LINE
118-88104	P204	1-1	12-4270-1	P122	4-2	121-52450	P113	4-6	124-66058	P111	4-3	12478608	P113	3-1	13119004	P17	3-4	14-187	P173	4-2	14-754	P119	1-1
118-88104	P204	1-2	12-4280-1	P122	4-2	121-52451	P192	2-1	124-78004	P111	2-3	12478707	P112	3-3	13149208	P9	3-4	14-192	P173	4-5	14-755	P119	1-3
118-88104	P204	1-4	12-4290-1	P122	4-2	121-52468	P113	5-5	124-78103	P112	2-2	12478806	P111	3-4	13150503	P10	1-2	14-3010	P118	1-4	14-756	P120	1-4
118-88104	P204	1-7	12-4300-1	P122	4-1	121-52955	P192	2-2	124-78202	P112	2-4	12478905	P113	3-4	13150602	P10	1-1	14-3170-1	P174	3-3	14-756	P119	4-2
118-88104	P205	1-1	12-4301-1	P122	4-2	121-52963	P192	2-3	124-78301	P112	2-1	12479101	P111	3-5	13150701	P9	2-6	14-3310	P118	1-4	14-756	P119	4-5
118-88104	P205	1-2	12-4360-1	P122	4-1	121-53755	P114	4-1	124-78400	P113	2-2	12480000	P111	3-3	131619005	P18	1-8	14-3320	P118	1-4	14-758	P174	1-2
118-88104	P206	1-1	12-4370-1	P122	4-1	121-53755	P115	4-2	124-78509	P113	2-3	12480000	P111	3-5	131619005	P18	2-8	14-3330	P118	1-4	14-760	P172	3-2
118-88104	P206	1-4	12-4380-1	P122	4-2	121-53763	P114	5-1	124-78608	P113	2-1	12480109	P111	3-4	13191408	P188	2-4	14-376	P127	1-2	14-763	P118	1-1
118-88104	P207	1-2	12-4640-1	P122	4-3	121-53763	P115	5-2	124-78707	P112	2-3	12480109	P112	3-2	13192406	P188	2-4	14-378	P175	1-3	14-764	P119	1-1
118-88104	P207	1-4	12-4780-1	P123	4-2	121-54258	P114	4-2	124-78806	P111	2-4	12480109	P112	3-3	13193206	P188	2-3	14-379	P175	1-4	14-765	P119	1-3
118-88203	P205	1-1	12-4980-1	P123	4-2	121-54258	P115	4-3	124-78905	P112	2-5	12480208	P112	3-4	133-29404	P208	2-1	14-4180-0	P121	1-3	14-765	P120	1-4
118-88302	P204	1-7	12-4980-1	P123	4-2	121-54266	P114	5-2	124-78905	P113	2-4	12480208	P113	3-2	133-34602	P208	3-1	14-421	P121	1-3	14-766	P119	4-2
118-88401	P204	2-3	12-4990-1	P123	4-2	121-54266	P115	5-3	124-79101	P111	2-5	12480208	P113	3-3	133-34701	P208	4-1	14-422	P121	1-4	14-766	P119	4-5
118-88401	P205	2-1	12-4990-1	P123	4-2	121-55552	P115	4-4	124-81008	P205	1-4	12480208	P113	3-4	133-37902	P208	1-1	14-424	P121	1-4	14-768	P174	1-2
118-88401/ZJ	P204	2-3	12-5810-1	P121	4-1	121-55560	P115	5-4	124-81107	P205	1-3	12480307	P112	3-1	134-20302	P208	4-2	14-426	P122	1-1	14-771	P174	1-3
118-88609	P206	3-2	12-591	P121	4-2	121-70908	P188	2-2	124-81107	P205	1-5	12480406	P113	3-1	134-20609	P208	3-2	14-427	P122	1-2	14-772	P174	1-3
118-90001	P204	6-1	12-8010-1	P196	4-3	121-71104	P115	3-4	124-81800	P205	2-2	12485009	P168	2-1	134-24809	P208	1-2	14-428	P122	1-2	14-773	P174	1-3
118-90001	P205	6-1	12-8020-1	P196	4-4	121-71500	P114	3-5	124-82600	P205	4-2	12485009	P168	2-3	134-60803	P9	3-1	14-429	P122	1-2	14-774	P174	1-3
118-90001	P206	6-1	12-8120-1	P196	4-5	121-72003	P114	2-5	124-84002	P205	6-2	12485108	P168	2-5	134-61801	P10	2-3	14-4301	P122	1-2	14-775	P174	1-3
118-90001	P207	5-1	12-8180-1	P118	5-3	121-72805	P114	2-1	124-84101	P205	5-2	12519001	P18	3-2	13458500	P15	3-2	14-431	P122	1-2	14-776	P174	1-5
118-90001	P207	5-2	12-8190-1	P118	5-3	121-73209	P114	2-2	124-84200	P205	5-3	12605004	P108	1-3	135-15507	P80	1-1	14-432	P122	1-1	14-777	P174	1-5
118-90100	P204	5-1	12-8190-1	P118	5-4	121-73209	P115	2-2	124-84408	P205	5-4	126100800	P191	4-1	135-15564	P79	2-1	14-436	P122	1-1	14-779	P174	2-1
118-90100	P204	5-3	12-8380-1	P118	5-2	121-73308	P114	2-3	124-84507	P205	7-2	12614004	P108	2-3	135-18600	P192	3-1	14-437	P122	1-1	14-782	P174	3-2
118-90100	P206	5-1	12-8390-1	P118	5-2	121-73308	P115	2-3	124-84606	P205	8-2	12615006	P108	1-4	135-18659	P192	3-2	14-464	P122	1-3	14-784	P174	1-4
118-90100	P207	4-1	12-8390-1	P196	4-2	121-73308	P115	2-5	12447504	P9	2-5	1261601000	P108	3-3	135-18709	P192	3-2	14-480	P123	1-2	14-785	P174	1-4
118-90100	P207	4-2	12-D1/8*15T	P124	4-2	121-73407	P188	2-1	12466157	P112	4-1	12634004	P108	4-3	135-48102	P192	3-6	14-496	P123	1-2	14-786	P174	2-3
118-90308	P204	5-2	12-D1/8*17	P125	4-1	121-74207	P115	2-4	12466553	P112	4-3	1287-09-01	P41	3-5	135-48151	P192	3-6	14-497	P123	1-2	14-790	P174	2-2
118-90308	P205	5-1	12-D1/8*21	P126	4-1	121-76004	P206	1-3	12466751	P112	4-4	1287-09-02	P41	3-6	135-48201	P192	3-5	14-553	P120	1-6	14-791	P174	2-2
118-90308	P206	5-2	12-D1/8*23	P126	4-2	121-76004	P207	1-3	12466850	P112	4-2	1287-09-03	P41	3-7	135-71906	P192	3-4	14-554	P175	1-1	14-798	P173	3-5
118-90308	P206	5-4	12-D1/8*23	P127	4-2	121-76103	P206	1-3	12467205	P192	2-4	129-23405	P109	1-1	135-71955	P192	3-4	14-563	P118	1-5	14-800	P174	4-4
118-90308	P207	4-1	12-D1/8*23T	P127	4-1	121-76103	P206	1-6	12470050	P112	4-5	129-25954	P109	5-1	135-72003	P192	3-3	14-5630-1	P118	4-5	14-8010	P173	3-1
118-90308	P207	4-3	12-D1/8*8	P122	4-3	121-76202	P206	1-3	12470159	P113	4-2	129-27760	P109	4-1	13612010	P17	3-3	14-566	P172	3-1	14-8020	P173	3-1
118945-001	P94	1-1	12-D3/16*13	P124	4-1	121-76202	P206	1-7	12470258	P113	4-3	129-32307	P109	2-1	13619001	P17	3-2	14-567	P172	3-3	14-806	P120	1-1
118946-101	P94	3-1	12-D3/16*15	P124	4-3	121-77903	P206	5-3	12470357	P113	4-1	129-40508	P208	6-3	13619002	P17	3-1	14-581	P121	1-1	14-807	P120	1-1
118947-001	P94	2-1	12-D3/16*17	P125	4-1	121-77903	P206	5-5	12473153	P113	4-4	129-40904	P208	6-1	137-31161	P16	1-1	14-582	P175	1-2	14-808	P120	1-1
119-49807	P113	3-6	120-03604	P204	3-1	121119001	P18	1-1	12476008	P111	3-3	129-41407	P208	6-4	137-35469	P16	1-2	14-583	P175	1-2	14-811	P174	2-4
119-49906	P113	2-6	120-03604	P204	4-2	121119009	P18	1-2	124760A6	P111	3-3	129-41803	P208	6-2	13719005	P17	2-1	14-591	P121	1-2	14-812	P174	3-1
119-91908	P206	1-7	120-04909	P9	4-8	122-57507	P115	6-2	12476107	P112	3-2	129-68509	P208	5-5	13719006	P17	2-2	14-611	P174	3-4	14-813	P174	3-1
119-99208	P204	1-1	120-14809	P204	3-2	122-75004	P115	6-4	124761A5	P112	3-2	129-68806	P208	5-6	137562	P25	4-5	14-612	P174	3-4	14-814	P174	2-4
119-99208	P204	1-3	120-14817	P204	3-2	122-75509	P114	6-5	12476206	P112	3-4	129-69101	P208	5-4	138-81255	P13	2-1	14-613	P174	4-1	14-818	P172	4-3
119-99208	P204	1-5	120-14908	P204	1-6	122-75509	P115	6-1	12476206	P113	3-2	12919303	P17	4-4	138-81255	P86	1-1	14-614	P174	4-1	14-819	P120	1-3
119-99208	P206	1-2	120-15300	P204	7-1	12220307	P9	2-1	12476206	P113	3-4	12919304	P17	4-5	138-81255	P86	2-1	14-615	P174	4-1	14-820	P120	1-3
119-99208	P206	1-5	120-15301	P205	7-1	12220406	P9	2-2	124762A4	P112	3-4	12922704	P10	3-6	138-82105	P86	2-1	14-616	P174	4-2	14-843	P173	2-1
119-99307	P204	2-1	120-15301	P206	7-1	123-83501	P207	1-1	124762B2	P113	3-4	12927200	P17	4-6	138-82501	P86	1-1	14-617	P174	4-3	14-844	P173	2-1
119-99307	P206	2-1	120-15301	P206	7-2	123-83501	P207	1-5	124762C0	P113	3-2	12E	P69	1-1	138-82501	P86	2-1	14-618	P174	4-3	14-845	P173	2-1
119-99307	P207	2-2	120-15301	P207	6-1	123-83600	P207	1-1	12476305	P112	3-1	12E(TFL)	P69	3-1	138-86304	P86	1-1	14-619	P173	1-4	14-846	P173	2-2
119-99307/ZJ	P204	2-1	120-15301	P207	6-2	123-83600	P207	1-5	124763A3	P112	3-1	12EW	P70	1-1	138-87302	P86	1-1	14-705	P173	4-1	14-847	P173	2-2
119-99802	P204	2-2	120-15400	P204	8-1	123-83808	P207	1-1	12476404	P113	3-3	12EW(KO)	P70	1-1	13819002	P17	1-4	14-712	P175	1-5	14-854	P119	1-2
119-99802	P206	2-1	120-15400	P205	8-1	123-84202	P207	2-1	124764A2	P113	3-3	12KM	P69	2-1	138559	P26	2-5	14-724	P119	1-1	14-854C	P173	2-4
119-99802	P206	2-2	120-15400	P206	8-1	123-84202	P207	2-3	12476503	P113	3-1	130	P60	2-3	13879800-1	P67	1-4	14-725	P119	1-3	14-854D	P173	2-5
119645																							



品号 PART NO.	页数 PAGE	行数 LINE	品号 PART NO.	页数 PAGE	行数 LINE	品号 PART NO.	页数 PAGE	行数 LINE	品号 PART NO.	页数 PAGE	行数 LINE	品号 PART NO.	页数 PAGE	行数 LINE	品号 PART NO.	页数 PAGE	行数 LINE	品号 PART NO.	页数 PAGE	行数 LINE	品号 PART NO.	页数 PAGE	行数 LINE
14-865	P119	1-4	14119005	P17	2-4	146569-001	P102	3-4	148973-001	P101	5-2	15-724	P119	2-1	151078-001	P92	2-3	155457-001	P99	3-4	159541-001	P3	3-7
14-865	P120	1-5	141509-101	P5	2-7	146572-001	P102	2-3	149671-101	P97	3-5	15-726	P119	5-2	151596-001	P93	1-3	155459-001	P100	3-3	159575-001	P99	3-5
14-866	P119	4-3	141514001	P79	1-1	146573-001	P102	2-4	149675-001	P100	2-4	15-727	P119	5-2	151596-001	P96	1-3	155459-001	P98	3-5	159575-101	P100	3-6
14-866	P119	4-6	141541-001	P5	3-4	146574-001	P102	2-5	149675-001	P97	2-4	15-729	P119	5-1	151597-101	P93	3-3	155461-001	P100	3-5	159575-101	P98	3-3
14-866B	P173	4-4	141541-101	P5	3-5	146577-001	P102	3-1	149677-001	P100	1-4	15-753	P119	3-1	151597-101	P96	3-2	155461-001	P98	3-3	159575-101	P99	3-2
14-868	P174	1-1	141543-001	P5	3-6	146577-001	P102	3-2	149677-001	P97	1-4	15-755	P119	3-1	151598-001	P93	2-3	155461-001	P99	3-1	159577-001	P93	1-3
14-870	P174	2-5	141546001	P78	1-1	146577-001	P102	3-3	149687-001	P97	3-2	15-756	P119	6-2	151598-001	P96	2-2	155461-001	P99	3-5	159577-001	P94	1-3
14-871	P173	1-1	141915001	P51	2-3	146577-001	P102	3-4	149691-001	P100	2-2	15-758	P119	6-1	152682-201	P89	1-1	155463-001	P100	3-1	159577-001	P96	1-3
14-873	P172	4-1	141915003	P51	1-3	146635-001	P201	4-2	149691-001	P97	2-2	15-760	P189	2-3	152686-201	P89	1-1	155463-001	P98	3-1	159577-001	P98	1-3
14-874	P172	4-1	141915007	P50	4-5	146635-001	P201	4-3	149938-001	P100	2-3	15-785	P188	3-3	152777-001	P191	2-1	155463-001	P98	3-4	159577-001	P99	1-2
14-875	P172	4-2	141915007	P172	1-6	146726-001	P200	5-1	149938-001	P97	2-3	15-786	P188	3-4	152778-001	P191	2-2	155463-001	P99	3-3	159577-001	P99	1-5
14-876	P172	4-2	141915008	P172	1-6	146726-001	P201	5-3	149940-001	P97	3-4	15-805	P118	2-2	152779-001	P191	2-4	155722-001	P100	1-1	159577-001A	P96	1-3
14-8780-1	P173	3-2	141915009	P172	1-6	146730-001	P102	1-1	149948-001	P100	2-4	15-805	P120	2-1	152780-001	P191	2-3	155722-001	P97	1-1	159686-001	P200	1-1
14-880	P118	1-3	141915010	P172	1-6	146731-001	P102	1-1	149948-001	P97	2-4	15-806	P120	3-1	152781-001	P191	2-5	155851-001	P100	1-2	159794-101	P92	4-1
14-882	P173	3-4	141915011	P172	1-6	146732-001	P102	1-1	149950-101	P97	3-5	15-807	P118	2-2	152782-001	P191	2-6	155851-001	P97	1-2	159799-001	P3	2-1
14-883	P173	3-3	142-130003	P81	2-1	146734-001	P166	2-1	149954-001	P100	1-4	15-807	P120	2-3	152897-201	P74	2-1	155853-001	P100	1-2	159884-001	P200	2-1
14-884	P172	3-4	142015001	P51	2-2	146735-001	P166	2-1	149954-001	P97	1-4	15-808	P120	3-2	152901-001	P3	4-7	155853-001	P97	1-2	159884-001	P200	2-3
14-885	P172	3-4	142015005	P172	1-5	146736-001	P166	2-1	15-024	P128	2-1	15-809	P188	3-7	152901-001	P74	2-1	155855-001	P100	1-2	159915-001	P3	4-3
14-886	P172	3-4	142111-001	P92	1-3	146744-001	P102	3-1	15-024.A	P128	2-2	15-811	P119	5-4	152904-001	P74	2-1	155855-001	P97	1-2	15E	P69	1-1
14-886	P172	4-4	142416-001	P5	4-2	146748-001	P102	2-1	15-034	P129	2-1	15-812	P119	6-4	152904-001	P78	1-1	155857-001	P100	1-3	15KM	P69	2-1
14-887	P172	3-5	142419-001	P5	4-1	146773-001	P102	5-2	15-034.A	P129	2-2	15-813	P119	5-3	152905-001	P3	4-8	155857-001	P97	1-3	164-01002	P14	1-7
14-888	P172	3-5	142515003	P172	2-3	146777-001	P200	5-2	15-046	P123	2-3	15-814	P119	6-3	152905-001	P74	2-1	156036-001	P102	2-2	164-03008	P14	1-8
14-890	P118	1-2	142515005	P172	2-5	146781-001	P102	1-2	15-047	P123	2-3	15-823	P120	2-2	152906-101	P74	2-1	156150-001	P74	2-1	164-16109	P14	2-6
14-890H	P172	4-4	142515008	P172	2-6	146781-001.M	P166	2-3	15-11T	P123	2-1	15-836	P189	1-1	152981-001	P74	2-1	156150-001	P167	2-1	164-16109.SH	P14	2-6
14-891	P118	1-2	142515010	P172	2-4	146782-001	P102	1-2	15-17T.A	P125	2-2	15-837	P189	1-2	152995-001	P74	2-1	156151-001	P74	2-1	164-18600	P14	2-5
14-892	P173	1-2	142519014	P44	4-3	146783-001	P166	3-1	15-301	P118	3-4	15-843	P118	3-1	153219-001	P74	2-1	156151-001	P167	2-2	164-18600.SH	P14	2-5
14-895	P172	4-5	143733-001	P102	1-1	146785-001	P166	2-4	15-315	P189	2-1	15-844	P118	3-1	153219-001	P78	1-1	156152-001	P74	2-1	164-18709	P14	2-3
14-897	P173	1-3	144-12506	P86	2-1	146786-001	P166	2-5	15-316	P189	2-2	15-853	P188	4-1	153220-001	P74	2-1	156152-001	P167	2-2	164-18709.SH	P14	2-3
14-D1/8*11T	P123	1-1	144049-001	P200	2-1	146871-101	P102	4-3	15-361	P118	2-5	15-854	P188	4-2	153222-001	P74	2-1	157	P33	4-7	16409906	P15	1-1
14-D1/8*15T	P124	1-2	144049-001	P201	2-2	146874-001	P102	4-4	15-376	P127	2-2	15-855	P118	2-3	153596-001	P74	2-1	158430-001	P95	2-3	164178	P187	1-2
14-D1/8*17	P125	1-1	144074-001	P2	1-7	146884-001	P102	4-1	15-4180-0	P121	2-3	15-856	P118	3-2	153597-001	P74	2-1	158430-001	P98	2-1	164550	P33	2-8
14-D1/8*21	P126	1-1	144074-300	P2	2-1	146902-001	P102	4-2	15-421	P121	2-3	15-857	P118	2-3	153598-001	P74	2-1	158430-001	P99	2-3	164728	P33	2-5
14-D1/8*23	P126	1-2	144127-001	P200	6-1	147176-001	P94	1-1	15-422	P121	2-4	15-858	P118	3-2	153882-001	P96	2-1	158433-001	P201	6-2	1650-161-RT	P20	1-3
14-D1/8*23T	P127	1-1	144127-001	P200	6-2	147176-001	P94	1-4	15-424	P121	2-4	15-859	P188	4-4	153882-001	P98	2-2	158791-101	P92	4-2	1650004-229	P35	1-6
14-D1/8*8	P122	1-3	144497-001	P191	1-4	147177-101	P94	3-1	15-426	P122	2-1	15-860	P188	4-3	153882-001	P99	2-4	158791-101	P93	4-1	166-07301(A-1)	P14	3-1
14-D3/16*13	P124	1-1	144629-001	P191	1-3	147177-101	P94	3-4	15-427	P122	2-2	15-861	P188	4-6	153887-001	P94	2-2	158791-101	P98	4-2	166-07301.CH(A-1)	P14	3-3
14-D3/16*15	P124	1-3	144635-001	P167	1-1	147178-001	P94	2-1	15-428	P122	2-2	15-862	P188	4-5	153887-001	P96	2-2	158792-101	P92	4-2	166-07301.SH(A-1)	P14	3-1
14-D3/16*17	P125	1-1	144635-001	P200	4-1	147934-001	P200	1-1	15-429	P122	2-2	15-867	P188	3-8	153887-001	P98	2-3	158792-101	P93	4-1	166-07400(A-2)	P14	3-2
140-30803	P209	2-5	144881-101	P93	1-2	147934-001	P200	1-2	15-4301	P122	2-2	15-870	P118	2-4	153887-001	P99	2-5	158792-101	P98	4-2	166-07400.CH(A-2)	P14	3-4
140-30902	P209	2-4	144881-101	P94	1-2	147935-001	P200	3-1	15-431	P122	2-2	15-875	P118	3-3	153892-001	P94	2-3	158793-101	P93	4-2	166-07400.SH(A-2)	P14	3-2
140-31017	P209	2-6	144881-101	P96	1-2	147936-001	P200	1-2	15-432	P122	2-1	15-880	P188	3-5	153892-001	P96	2-3	158794-101	P92	4-3	166-07509(B-1)	P14	3-5
140-31116#04	P209	2-1	144881-101	P98	1-3	148013-101	P102	4-5	15-436	P122	2-1	15-881	P188	3-6	153892-001	P98	2-3	158794-101	P98	4-1	166-07509.CH(B-1)	P14	4-1
14013009	P17	2-7	144881-101	P99	1-1	148119003	P43	1-1	15-437	P122	2-1	15-D1/8*15T	P124	2-2	153892-001	P99	2-5	158795-101	P93	4-3	166-07509.SH(B-1)	P14	3-5
140135	P178	2-1	144881-101	P99	1-5	148342-001	P2	2-2	15-464	P122	2-3	15-D1/8*17	P125	2-1	153897-001	P94	2-3	158795-101	P94	4-3	166-07608(B-2)	P14	3-6
14019001	P17	3-7	144882-001	P93	1-2	148681-001	P97	3-1	15-480	P123	2-2	15-D1/8*21	P126	2-1	153897-001	P96	2-3	158795-101	P98	4-3	166-07608.CH(B-2)	P14	4-2
14019002	P17	3-8	144882-001	P96	1-2	148691-001	P97	3-2	15-496	P123	2-2	15-D1/8*23	P126	2-2	153897-001	P98	2-3	158796-101	P92	4-4	166-07608.SH(B-2)	P14	3-6
140242-001	P2	3-1	144882-001	P98	1-5	148695-001	P97	3-2	15-497	P123	2-2	15-D1/8*23T	P127	2-1	153897-001	P99	2-5	158796-101	P92	4-4	166-07707(C-1)	P14	4-3
140319001	P19	2-5	145246-001	P167	1-2	148699-001	P100	2-1	15-535	P118	3-5	15-D1/8*8	P122	2-3	153907-001	P94	2-4	158797-101	P93	4-3	166-07707.CH(C-1)	P14	4-5
140319002	P19	2-6	146487-001	P196	1-1	148699-001	P97	2-1	15-536	P118	2-6	15-D3/16*13	P124	2-1	154568-001	P3	1-6	158797-101	P98	4-3	166-07707.SH(C-1)	P14	4-3
14041206	P45	3-2	146489-001	P102	5-3	148703-001	P100	2-2	15-553	P120	2-5	1											

品号 PART NO.	页数 PAGE	行数 LINE
17-0064-5-864 3/5CA	P47	2-2
17-0064-5-864 3/5CB	P47	2-3
17-0064-5-951	P47	3-2
17-0460-1	P123	3-3
17-0470-1	P123	3-3
17-111T	P123	3-1
17-177T	P125	3-2
17-23	P34	1-6
17-3010-1	P191	3-2
17-3610-1	P118	4-4
17-3710-1	P121	3-3
17-3720-1	P121	3-4
17-3740-1	P121	3-4
17-3750-1	P121	3-3
17-3760-1	P122	3-1
17-3760-1	P191	3-3
17-3770-1	P122	3-2
17-3810-1	P122	3-2
17-3820-1	P122	3-1
17-3960-1	P123	3-2
17-3970-1	P123	3-2
17-4280-1	P122	3-2
17-4640-1	P122	3-3
17-4780-1	P123	3-2
17-5060-K	P22	2-5
17-5760-1	P121	3-2
17-58	P34	1-5
17-5810-1	P121	3-1
17-7620-1	P118	4-1
17-7680-1	P118	4-2
17-7690-1	P118	4-2
17-7690-1	P118	4-3
17-8770-1	P191	3-1
17-9290-1	P191	3-4
17-9300-1	P191	3-4
17-9360-1	P191	3-5
17-D1/8*15T	P124	3-2
17-D1/8*17	P125	3-1
17-D1/8*21	P126	3-1
17-D1/8*23	P126	3-2
17-D1/8*23	P127	3-2
17-D1/8*23T	P127	3-1
17-D1/8*8	P122	3-1
17-D3/16*13	P124	3-1
17-D3/16*15	P124	3-3
17-D3/16*17	P125	3-1
170619060	P44	4-1
170619062	P44	3-6
170619069	P44	4-2
170619080	P44	4-4
170619083	P44	4-5
170619087	P44	3-7
176094	P42	3-5
179458-05	P27	2-3
179459-05	P27	2-2
179630-92	P138	5-1
179630-92	P139	5-1
179630-920	P136	5-3
179630-920	P137	5-1
179630-920	P140	6-1
18-025	P128	6-1
18-033	P129	6-1
18-11T	P123	6-1

品号 PART NO.	页数 PAGE	行数 LINE
18-17T	P125	6-2
18-4180-1	P121	6-1
18-4210-1	P121	6-1
18-4220-1	P121	6-2
18-4240-1	P121	6-2
18-4260-1	P122	6-1
18-4270-1	P122	6-2
18-4280-1	P122	6-2
18-4290-1	P122	6-2
18-4301-1	P122	6-2
18-4310-1	P122	6-2
18-4320-1	P122	6-1
18-4360-1	P122	6-1
18-4370-1	P122	6-1
18-4640-1	P122	6-3
18-4800-1	P123	6-2
18-4960-1	P123	6-2
18-4960-1	P123	6-2
18-4970-1	P123	6-2
18-4970-1	P123	6-2
18-551	P211	5-2
18-805	P211	5-1
18-806	P211	6-1
18-D1/8*15T	P124	6-2
18-D1/8*17	P125	6-1
18-D1/8*21	P126	6-1
18-D1/8*23	P127	6-2
18-D1/8*23T	P127	6-1
18-D1/8*8	P122	6-3
18-D3/16*13	P124	6-1
18-D3/16*15	P124	6-3
18-D3/16*17	P125	6-1
18011900100	P20	2-1
1802	P44	1-5
181716-001	P101	4-3
181722-001	P196	1-3
18211900100	P20	3-2
182119002	P20	2-2
182319201	P20	4-3
182319202	P20	4-4
183954-001	P101	4-1
183978-001	P101	4-2
18510911000	P20	4-1
185119002	P20	3-7
185119104	P20	4-2
185209102	P20	3-1
185219001	P19	4-4
185219002	P19	4-5
185219004	P19	4-6
185319001	P20	1-2
185319002	P20	1-1
185319003	P20	1-1
185319004	P20	1-2
18551930100	P20	3-6
185519303	P20	3-5
18561900200	P20	3-4
18561900300	P20	3-3
188-87106	P114	3-5
1891-4	P42	2-3
19-025	P128	5-1
19-033	P129	5-1
19-112	P211	1-2

品号 PART NO.	页数 PAGE	行数 LINE
19-112A	P211	1-2
19-112S	P211	1-2
19-11T	P123	5-1
19-17T	P125	5-2
19-287	P210	2-1
19-288	P210	2-2
19-351	P209	4-2
19-353	P209	4-1
19-362	P209	5-2
19-363	P209	5-1
19-404	P210	4-1
19-405	P210	4-2
19-4140-1	P123	5-2
19-416	P210	4-4
19-416	P211	2-2
19-416	P211	2-3
19-4180-1	P121	5-1
19-4210-1	P121	5-1
19-4220-1	P121	5-2
19-4240-1	P121	5-2
19-4260-1	P122	5-1
19-4270-1	P122	5-2
19-4280-1	P122	5-2
19-4290-1	P122	5-2
19-4300-1	P122	5-1
19-4301-1	P122	5-2
19-431	P210	3-2
19-431A	P210	3-1
19-431A	P210	3-2
19-431B	P210	3-1
19-431B	P210	3-2
19-431N	P210	3-1
19-431N	P210	3-2
19-431S	P210	3-1
19-431S	P210	3-2
19-432	P211	1-1
19-4320-1	P122	5-1
19-432A	P211	1-1
19-432B	P211	1-1
19-432N	P211	1-1
19-432S	P211	1-1
19-4360-1	P122	5-1
19-437	P210	4-3
19-4380-1	P122	5-2
19-439	P211	2-1
19-4640-1	P122	5-3
19-486	P209	5-6
19-4960-1	P123	5-2
19-4960-1	P123	5-2
19-4970-1	P123	5-2
19-4970-1	P123	5-2
19-505	P211	4-2
19-505	P211	4-3
19-525	P211	3-3
19-531	P209	4-4
19-535	P209	4-3
19-535	P209	4-5
19-536	P209	4-6
19-539	P211	3-2
19-546	P209	5-3
19-581	P210	1-3
19-581	P210	1-5

品号 PART NO.	页数 PAGE	行数 LINE
19-581	P210	2-4
19-582	P210	1-2
19-582	P210	2-3
19-583	P210	1-4
19-592	P210	2-5
19-593	P210	2-6
19-712	P210	1-1
19-801	P211	3-1
19-807	P211	4-1
19-837	P209	5-4
19-838	P209	5-5
19-D1/8*15T	P124	5-2
19-D1/8*17	P125	5-1
19-D1/8*21	P126	5-1
19-D1/8*23	P126	5-2
19-D1/8*23	P127	5-2
19-D1/8*23T	P127	5-1
19-D1/8*8	P122	5-3
19-D3/16*13	P124	5-1
19-D3/16*15	P124	5-3
19-D3/16*17	P125	5-1
19S01-013G01(1/4)	P187	1-4
19S09-005P01	P39	4-3
2		
200954	P178	2-1
200959	P25	4-6
200971	P26	2-6
201121A	P26	3-3
201121A0	P26	3-5
201121ANS	P26	3-4
201127	P25	3-5
201152E/201155C	P131	4-3
201152E/201155C	P133	4-4
201152E/277103	P138	4-3
201152E/277115	P138	4-3
201152E/201155C0	P136	4-5
20119002	P17	4-7
20119008	P49	1-1
201230C	P193	1-1
201230C/201224B	P131	4-6
201230C/201224B	P133	4-5
201230C/205525	P131	4-5
201230C/205525	P134	4-1
201230C/208050A	P134	4-5
201230C/210370	P138	4-1
201230C/210371	P138	4-1
201230C/210503	P139	4-2
201230C/210504	P139	4-2
201230C0/2055250	P136	4-4
201230C0/2103710	P137	4-1
201308	P27	3-6
201310A	P193	1-1
201473B/301433	P134	4-2
202091	P218	3-2
202092	P218	3-1
202092	P218	3-2
202092	P218	6-1
202094	P218	2-1
202094	P218	2-2
202094	P218	2-4
202095	P218	2-2
202095	P218	2-4
202142-0-10	P29	1-3

品号 PART NO.	页数 PAGE	行数 LINE
202143-0-10	P29	2-2
202146-0-10	P28	3-2
202194-0-11	P29	4-5
202295	P25	3-2
2022950	P25	3-4
202403	P178	2-2
202408	P213	2-2
202413	P218	2-1
202413	P218	2-4
202413	P218	5-1
202451	P27	3-7
202499E1	P137	1-2
202527A	P26	3-1
202546E	P131	1-6
202546E	P133	1-6
202546E1	P137	1-1
202554E	P132	1-1
202554E	P134	1-4
202554E-H	P178	3-3
202554E-T	P177	3-1
202554E1	P137	1-2
202570	P26	3-2
202617	P131	1-3
202618	P178	2-3
202618A	P134	1-2
202675	P131	1-4
202702	P131	1-4
202703	P213	2-2
20271	P37	3-5
202733	P189	3-4
202734	P189	3-3
202799/205525	P139	4-1
202799/210371	P138	4-2
202799/210372	P138	4-2
202828	P213	1-3
202840	P213	3-1
202840	P213	3-2
202840	P214	3-1
202842	P213	1-4
202842	P214	1-1
202861	P213	2-3
202861	P214	2-1
202872	P214	1-1
202874	P213	1-4
202874	P214	1-1
202893	P25	3-1
202893[HSS]	P25	3-1
202932-0-10	P29	1-5
202977/205525	P138	4-4
202983	P134	1-6
203010-0-10	P29	2-3
203012-0-10	P28	3-6
203066-0-10	P29	1-6
203069-0-10	P28	4-3
203759-0-10	P29	2-4
203783-0-10	P29	1-4
204021	P218	1-4
204022	P218	1-1
204033	P218	1-1
204033	P218	4-1
204039B	P132	1-3
204039B	P177	3-3
204039B-2	P177	3-3

品号 PART NO.	页数 PAGE	行数 LINE
204042	P216	7-1
204062	P213	1-1
204062	P214	1-2
204062	P215	1-1
204062	P215	1-3
204062	P215	1-4
204062	P215	1-5
204066-T	P177	3-5
204072	P213	2-1
204072	P214	2-2
204072	P215	2-1
204072	P215	2-2
204072	P215	2-3
204072	P215	2-4
204072	P216	2-1
204072/ZJ	P215	2-2
204161	P25	3-7
2041610	P25	4-1
204161A	P25	4-2
20419001	P18	1-5
204248B	P132	3-3
204248B	P133	3-1
204248B	P135	3-4
204248B	P189	3-6
204248B0	P137	3-3
204278	P214	3-2
204294B	P132	1-3
204294B	P177	3-3
204314A	P214	4-1
204351	P25	4-8
204360A	P133	1-1

品号 PART NO.	页数 PAGE	行数 LINE	品号 PART NO.	页数 PAGE	行数 LINE	品号 PART NO.	页数 PAGE	行数 LINE	品号 PART NO.	页数 PAGE	行数 LINE
205465	P134	1-1	208066	P132	3-5	208648	P136	1-2	209668	P215	5-3
2054651	P136	1-3	208066	P133	3-3	208649	P133	4-3	209668	P216	5-1
205607	P26	2-7	208066	P135	3-3	208649	P136	4-3	209669	P215	8-1
205609	P26	1-1	208066	P136	3-2	208730/208731	P131	4-4	209669	P216	8-1
205773	P131	1-3	2080660	P137	3-2	208730/208731	P132	4-1	209669A	P216	8-1
205773	P133	1-5	208074	P132	3-6	208730/208731	P134	4-4	209670	P197	1-1
2057731	P136	1-4	208074	P136	3-1	208730/208732	P131	4-4	209670-92	P131	5-3
205890	P26	3-6	208078-BF	P131	3-5	208730/208732	P132	4-1	209670-92	P131	5-5
205891	P213	1-3	208078-BF	P132	3-1	208730/208732	P134	4-4	209670-92	P133	5-3
206097C	P217	1-2	208078-BF	P133	3-5	2087300/2087321	P137	4-2	209670-92	P134	5-1
206097D	P217	1-2	208078-BF	P134	3-4	208905	P131	5-4	209685	P215	4-1
20619004	P18	1-6	208078-BF0	P137	3-1	208905	P132	5-1	209685	P216	4-1
20619009	P18	2-4	208079-BF	P132	3-2	208905	P134	5-2	209685AC0009	P215	4-1
20619011	P49	1-3	208083	P134	3-3	208905	P134	5-4	209685AC0009	P216	4-1
20619012	P49	1-2	208083-BF	P134	3-6	208905A92	P135	5-1	209732	P135	1-1
206276	P179	3-2	208090-BF	P131	3-2	208906A92	P134	5-3	209733000019	P215	1-2
206280	P218	1-4	208090-BF	P133	3-4	208909	P132	5-2	209733000019	P216	1-1
206512	P218	1-2	208090-BF0	P136	3-4	208909B92	P135	5-2	209740-16F	P135	3-1
206512	P218	4-1	208090A16	P134	3-2	208909B92	P136	5-1	209741-16F	P135	3-1
206512	P218	4-2	208215	P132	2-2	208910	P133	5-1	209742-16F	P135	2-1
206513	P218	1-1	208215	P133	2-1	208910B92	P135	5-3	20RAS261	P20	1-6
207000-2-00	P29	2-7	208215	P135	2-4	208911	P131	3-4	21-3003	P40	1-2
207002-2-00	P29	3-5	2082150	P137	2-3	208911	P134	3-1	21-4001	P40	1-3
207003-2-00	P29	3-2	208217	P132	2-3	2089110	P136	3-3	2100167	P35	4-1
207004-2-00	P29	3-6	208217	P133	2-3	208912	P131	3-4	2101155	P38	2-4
20701053	P18	2-1	208217	P135	2-5	208912	P134	3-1	2101156	P38	2-3
207015-2-00	P28	3-4	2082170	P137	2-4	2089120	P136	3-3	2101220	P38	1-7
207016-2-00	P28	4-1	208218	P135	2-2	208914	P197	1-2	2101221	P38	1-8
207020-2-00	P29	1-1	208219	P132	2-4	208955	P133	4-2	210259	P214	1-4
207020-2-01	P29	1-1	208219	P133	2-4	208955	P135	4-5	210354	P214	2-4
20715201	P171	2-4	208219	P135	2-3	208965	P133	5-2	210356	P214	2-3
20719003-A	P49	2-3	208219	P136	2-2	208965B92	P136	5-2	210356	P214	2-4
20719004	P49	1-5	2082190	P137	2-2	209009	P213	5-1	210356	P214	2-5
20719005	P18	2-2	208224	P189	3-5	209009	P214	6-1	210357	P214	4-1
20719006	P49	1-4	208225	P133	2-2	209009	P215	6-1	210357	P214	4-2
20719007	P18	2-3	208393	P26	1-2	209009	P216	6-1	210358	P214	1-4
20719050	P18	2-5	208501	P132	4-3	2090600	P137	3-2	210359	P214	1-4
207651-0-00	P28	4-5	208501	P135	4-2	209209	P213	1-2	210361	P214	3-3
208059	P132	3-3	208502	P133	4-1	209209	P215	1-5	210362	P214	3-3
208059	P132	3-4	208502	P135	4-4	209248	P218	4-3	210363	P214	3-3
208059	P133	3-1	208504	P132	4-4	209249	P218	1-3	210364	P214	1-3
208059	P133	3-2	208504	P135	4-3	209264	P218	5-2	210364	P214	1-4
208059	P135	3-4	208506	P133	4-2	209265	P218	2-3	210364	P214	1-5
208059	P135	3-5	208506	P135	4-5	209266	P218	2-3	210365	P214	1-3
208059	P189	3-6	208506S	P193	1-2	209267	P218	2-3	210365	P214	1-4
2080590	P137	3-3	208508	P132	4-5	209310	P218	7-1	210365	P214	1-5
2080590	P137	3-4	208508	P136	4-1	209340-2-01	P29	3-1	210367	P214	1-3
208060	P132	3-5	208525	P131	4-3	209341-0-00	P29	2-6	210367	P214	1-5
208060	P133	3-3	208525	P131	4-4	209341-0-10	P29	2-6	210368	P214	1-3
208060	P135	3-3	208525	P131	4-5	209342-2-01	P29	3-7	210368	P214	1-4
208060	P136	3-2	208525	P131	4-6	209344-2-00	P28	4-6	210371	P215	1-1
208061	P132	3-6	208525	P132	4-1	209347-2-01	P29	3-3	210512	P214	3-4
208061	P136	3-1	208525	P132	4-2	209348-0-00	P29	4-1	210513	P214	3-4
208063	P132	3-3	208525	P133	4-4	209348-0-10	P29	1-7	210514	P214	3-4
208063	P133	3-1	208525	P133	4-5	209350-0-00	P29	2-5	2107032	P156	4-1
208063	P135	3-4	208525	P134	4-1	209350-0-10	P29	2-5	2107100	P157	4-2
208063	P189	3-6	208525	P134	4-2	209351-2-01	P29	3-4	2107100	P194	4-1
2080630	P137	3-3	208525	P134	4-3	209352-0-00	P29	4-2	2107102	P157	4-3
208064	P132	3-4	208525	P134	4-4	209356-0-00	P29	2-1	2107102	P194	4-2
208064	P133	3-2	208525	P134	4-5	209416-26F	P134	3-5	2107118	P158	4-2
208064	P135	3-5	208525	P134	4-6	209417A25F	P134	2-5	210728	P214	1-4
2080640	P137	3-4	208525	P135	4-1	209508-45	P134	1-5	2107290/2107240	P194	3-2
208065	P135	3-2	208648	P133	1-4	209509-25F	P134	3-5	210730	P214	1-4

品号 PART NO.	页数 PAGE	行数 LINE	品号 PART NO.	页数 PAGE	行数 LINE	品号 PART NO.	页数 PAGE	行数 LINE	品号 PART NO.	页数 PAGE	行数 LINE
2107300	P156	4-2	2109005	P190	2-3	2109214	P225	5-2	211507	P214	1-4
2107301	P156	4-3	2109006	P156	3-2	2109300	P222	3-1	211507	P214	1-5
2107308	P194	3-3	2109006	P157	3-1	2109300	P222	3-2	211662	P26	4-2
2107309	P194	3-3	2109006	P158	3-1	2109300	P222	3-3	211662A	P26	4-3
2107310	P156	4-4	2109006	P158	3-2	2109300	P223	2-2	211719	P214	1-4
2107311	P157	4-1	2109006/2109052	P190	2-4	2109300	P225	2-2	211719	P214	1-5
210755	P26	4-1	2109007	P156	2-2	2109300/ZJ	P223	2-2	211720	P214	1-4
210783	P178	2-5	2109009	P157	2-1	2109301	P223	1-3	2118009	P184	3-2
210784	P178	2-5	2109009	P158	2-2	2109302	P223	3-1	2119000/2119015	P190	1-4
210796	P178	3-1	2109050	P157	2-2	2109302	P225	4-1	2119002	P190	1-3
210797	P178	3-1	2109050	P157	2-4	2109320	P222	2-1	2119320	P225	1-1
210799	P178	3-2	2109050	P158	2-3	2109320	P222	2-2	2119321	P225	1-1
210800	P178	3-2	2109050	P190	2-1	2109320	P223	1-2	2119322	P225	1-1
2108000	P156	1-1	2109051	P157	3-2	2109320	P223	1-4	2119323	P225	1-1
2108002	P156	1-2	2109051	P157	3-4	2109320	P224	1-1	2119324	P225	2-1
2108003	P156	1-3	2109051/2109052	P190	2-2	2109320	P224	1-3	2120000708	P23	1-5
2108004	P156	1-4	2109052	P157	3-2	2109320	P225	1-2	2120000715	P22	4-5
2108004	P184	1-4	2109052	P157	3-3	2109320/ZJ	P223	1-2	212010010	P22	4-6
2108005	P157	1-1	2109052	P157	3-4	2109320/ZJ	P223	1-4	2121107	P36	4-6
2108005	P158	1-1	2109052	P157	3-5	2109320/ZJ	P224	1-1	2121111	P35	4-3
2108005	P158	1-2	2109052	P158	3-3	2109320/ZJ	P224	1-3	212182/201310A	P134	4-6
2108005	P184	1-4	2109052	P158	3-4	2109320/ZJ	P225	1-2	212182/210371	P134	4-3
2108006	P184	2-1	2109055	P157	2-3	2109322	P222	2-3	212207-113[HSS]	P40	4-1
2108008	P183	4-2	2109055	P157	2-5	2109322	P222	2-5	212215	P214	2-3
2108017	P183	4-1	2109055	P158	2-4	2109322	P224	1-4	2122207-113	P40	4-1
210804	P178	3-4	2109056	P157	3-3	2109322	P225	1-2	212644	P214	2-4
210805	P178	3-4	2109056	P157	3-5	2109322/ZJ	P222	2-3	213-89200	P16	2-1
2108050	P157	1-2	2109056	P158	3-3	2109322/ZJ	P222	2-5	213-89309	P16	2-2
2108050	P157	1-4	2109056	P158	3-4	2109322/ZJ	P224	1-4	213011	P40	1-7
2108050	P158	1-3	2109067	P156	3-1	2109322/ZJ	P225	1-2	213014	P40	1-6
2108050	P184	4-1	2109067	P156	3-2	2109324	P222	2-2	213108	P26	1-3
2108052	P157	1-3	2109067	P157	3-1	2109324/ZJ	P222	2-2	213108A	P26	1-4
2108052	P157	1-5	2109067	P158	3-1	2109326	P222	2-3	213111-60	P179	1-4
2108052	P158	1-4	2109067	P158	3-2	2109328	P225	3-1	21317002	P18	1-4
2108052	P184	4-2	2109100	P156	5-1	2109331	P222	3-2	2150256	P36	4-2
210806	P178	3-5	2109101	P156	5-2	2109331	P223	2-1	2151024	P38	3-4
2108062	P184	2-4	2109101	P157	5-1	2109334	P224	2-2	2151025	P38	3-3
2108064	P184	2-5	2109101	P198	2-1	2109334	P225	2-3	2151025	P158	4-1</



索引表 PARTS LIST

INDUSTRIAL SEWING MACHINE SPARE PARTS

索引表 PARTS LIST

INDUSTRIAL SEWING MACHINE SPARE PARTS



品号 PART NO.	页数 PAGE	行数 LINE	品号 PART NO.	页数 PAGE	行数 LINE	品号 PART NO.	页数 PAGE	行数 LINE	品号 PART NO.	页数 PAGE	行数 LINE	品号 PART NO.	页数 PAGE	行数 LINE	品号 PART NO.	页数 PAGE	行数 LINE	品号 PART NO.	页数 PAGE	行数 LINE	品号 PART NO.	页数 PAGE	行数 LINE
2169113	P198	4-4	236606[HSS]	P26	1-7	257030B48	P142	1-5	257262-16F	P143	2-1	259203-16F	P145	2-2	277012	P216	1-3	277309-13	P139	3-1	277309-13	P139	3-1
21700	P228	1-3	236606A	P26	2-3	257031B56	P180	1-2	257266-16F	P143	2-3	259215-16F	P144	2-2	277014	P216	3-1	277315-16F	P138	3-5	277315-16F	P138	3-5
21754	P228	2-3	236608	P26	1-6	257032B56	P180	1-1	257267-16F	P143	2-2	259218A16F	P189	4-4	277014A	P216	3-1	277315-16F	P139	3-1	277318-13	P138	3-1
21787	P183	4-4	236608.SH	P26	1-6	257033A56	P180	1-3	257267-16F	P143	2-3	259234-16F0	P189	4-2	277014B	P216	3-1	277318-13	P138	3-1	277318-13	P138	3-1
2200850222	P23	2-2	236608[HSS]	P26	1-6	257033A64	P180	1-3	257267-16F	P143	2-3	259246-16F	P141	2-2	277015	P216	2-2	277318-13	P138	3-2	277318-13	P138	3-2
2200850227	P23	1-1	236609	P217	7-1	257033B56	P143	1-1	257268-16F	P143	2-4	259608B56	P180	2-4	277015	P216	2-3	277318-13	P138	3-4	277318-13	P138	3-4
2206110119	P22	4-4	236609/ZJ	P217	7-1	257033B56	P144	1-5	257289-16F	P144	2-1	259614B56	P180	2-5	277015	P216	2-4	277318-13	P139	3-2	277318-13	P139	3-2
2206110120	P23	2-3	236610	P217	8-1	257033B64	P143	1-1	257290-16F	P144	2-1	259620B56	P179	2-5	277015/ZJ	P216	2-2	277318-13	P139	3-3	277318-13	P139	3-3
22100902372	P23	2-1	236618	P26	2-4	257033B64	P144	1-5	257291-16F	P144	2-3	259620B5601	P179	3-1	277015A	P216	2-3	277318-13	P139	3-4	277318-13	P139	3-4
2210090242	P22	4-1	236618[HSS]	P26	2-4	257033C56-18	P180	1-4	257292-16F	P144	2-3	259620B6401	P179	3-1	277015A	P216	2-4	277318-13	P140	3-1	277318-13	P140	3-1
22195	P35	4-4	236631-56	P197	1-7	257033C56-20	P180	1-5	257292-16F	P144	2-3	26135	P194	4-5	277016	P216	2-3	277318-13	P140	3-2	277318-13	P140	3-2
225-57458	P85	2-1	2400100274	P23	4-1	257049B32	P143	1-3	257293-16F	P144	2-4	261416	P60	3-8	277016A	P216	2-3	277318-13	P140	3-3	277318-13	P140	3-3
225-57557	P14	1-1	241372	P187	1-1	257050B40	P143	1-3	257317A32	P144	4-4	2615	P60	3-2	277017	P216	1-4	277318-13	P140	3-4	277318-13	P140	3-4
225-57557	P85	2-1	24306	P66	1-3	257050B48	P143	1-3	257317A32	P142	4-3	2631-T	P59	2-1	277018	P216	4-2	277318-130	P141	3-1	277318-130	P141	3-1
225-57706	P14	1-2	246-2553	P7	1-1	257051B48	P143	1-2	257317A40	P144	4-4	2631-T(TFL)	P59	2-2	277018C	P216	4-2	277318A13	P138	3-3	277318A13	P138	3-3
225-57706	P85	2-1	246-2553.SH	P7	1-1	257053B56	P143	1-4	257317A48	P144	4-4	2631-T[4A]	P59	2-1	277019	P216	1-3	2773200	P141	4-1	2773200	P141	4-1
225-57805	P85	2-1	246-2553[T]	P7	1-2	257053B64	P143	1-4	257318A40	P142	4-4	2631-T[5A]	P59	2-1	277022-92	P139	5-2	277323-16	P139	3-3	277323-16	P139	3-3
225-57904	P85	2-1	246.27-11	P49	3-1	257067B56	P180	2-1	257318A48	P142	4-4	2652197	P7	2-5	277022-920	P140	6-2	277323-160	P141	3-1	277323-160	P141	3-1
225-58001	P85	2-1	246.27-11C	P50	3-1	257082B56	P179	3-3	257321A56	P143	4-1	268370	P221	5-3	277022920	P137	5-2	277324-16	P139	3-3	277324-16	P139	3-3
225-58100	P85	2-1	246.27-12	P49	3-2	257090B56	P142	1-2	257321A56	P144	4-5	268380	P221	5-4	277027-92	P139	5-3	277324-160	P141	3-1	277324-160	P141	3-1
225-58209	P85	2-1	246061	P39	1-3	257090B64	P142	1-2	257321A64	P143	4-1	268382	P221	5-5	277027-920	P141	6-1	277325-16	P139	2-3	277325-16	P139	2-3
225-58308	P85	2-1	246071	P39	1-4	257090C56	P142	1-3	257321A64	P144	4-5	270-075	P218	2-5	277027-921	P137	5-3	277325-160	P141	2-1	277325-160	P141	2-1
225-58407	P85	2-1	25-14	P34	1-4	257097B56	P144	1-3	257327A32	P143	4-3	270-112	P29	1-3	277028-92	P140	5-1	277327-16	P139	3-4	277327-16	P139	3-4
22548010A	P168	4-5	252058-92	P141	6-2	257097B64	P144	1-3	257328A40	P143	4-3	270-112/1	P29	2-2	277029-92	P140	5-2	277327-16	P140	3-1	277327-16	P140	3-1
22548119A	P188	1-3	252059-92	P141	7-1	257100B40	P145	1-1	257328A48	P143	4-3	270-113	P28	3-1	277029-920	P137	5-4	277327-16	P140	3-3	277327-16	P140	3-3
22581409S.A	P168	4-4	253647	P33	3-5	257100B48	P145	1-1	257330A48	P143	4-2	270-113/1	P28	3-2	277030-92	P140	5-3	277328-16	P139	3-4	277328-16	P139	3-4
22581508A	P188	1-4	253775	P33	3-3	257102B348	P180	2-2	257350-32	P193	1-3	27002	P184	3-1	277031-92	P197	1-3	277328-16	P140	3-1	277328-16	P140	3-1
22581508S	P188	1-5	25492	P65	1-5	257105B56	P145	1-2	257460-32	P144	4-1	277034	P216	2-3	277034	P216	2-3	277328-16	P140	3-3	277328-16	P140	3-3
226-40353	P105	3-5	2560	P41	2-1	257102B64	P145	1-2	257460-32	P141	4-3	277034/ZJ	P216	2-3	277034/ZJ	P216	2-3	277329-16	P140	2-1	277329-16	P140	2-1
226-40551	P105	3-5	25626	P40	2-4	257102C56	P180	2-3	257460-40	P144	4-1	277036	P216	1-2	277036	P216	1-2	277329-16	P140	2-3	277329-16	P140	2-3
226-40858	P105	3-5	256271.5A	P39	2-2	257102C6400	P180	2-3	257460-40	P141	4-3	277112/208651	P139	4-3	277112/208651	P139	4-3	277330-16	P139	2-4	277330-16	P139	2-4
226-40957	P105	3-3	256281.5A	P39	2-1	257105B56	P179	3-4	257460-48	P144	4-1	277118	P139	4-4	277118	P139	4-4	277337-25	P140	3-2	277337-25	P140	3-2
226-40957	P106	3-1	25655	P40	2-5	257105B64	P179	3-4	257460-48	P141	4-3	2771180	P137	4-3	2771180	P137	4-3	277338-25	P140	3-2	277338-25	P140	3-2
226-41252	P106	3-1	2569	P41	2-2	257108B56	P179	3-5	257461-48	P141	4-4	277118A0	P140	4-3	277118A0	P140	4-3	277339-25	P140	2-2	277339-25	P140	2-2
226-41351	P106	3-2	257001B56	P179	3-2	257108B64	P179	3-5	257461-56	P144	4-2	277119	P140	4-1	277119	P140	4-1	2773450	P140	4-5	2773450	P140	4-5
226-41450	P106	3-2	257015B32	P144	1-1	257111C48	P179	2-4	257461-56	P141	4-4	2771190	P137	4-4	2771190	P137	4-4	277379-25	P189	3-2	277379-25	P189	3-2
226-55302	P16	3-5	257015B32	P141	1-3	257180-64	P141	1-2	257461-56	P142	4-1	277122	P140	4-2	277122	P140	4-2	277380-25	P189	3-1	277380-25	P189	3-1
2273110120	P23	2-4	257015B40	P144	1-1	257203A16F	P143	3-5	257461-64	P144	4-2	2771220	P137	4-5	2771220	P137	4-5	277500P30	P138	1-1	277500P30	P138	1-1
227682	P7	2-3	257015B40	P141	1-3	257206-16F	P141	3-3	257461-64	P141	4-4	277149-400	P140	4-4	277149-400	P140	4-4	277500P30	P138	1-4	277500P30	P138	1-4
227683	P7	2-4	257015B48	P144	1-1	257207-16F	P141	3-4	257468-56	P144	4-3	277149-400	P140	5-4	277149-400	P140	5-4	277500P40	P138	1-1	277500P40	P138	1-1
227683[T]	P7	2-4	257015B48	P141	1-3	257207-16F	P142	3-1	257468-56	P142	4-2	277151-400	P140	5-5	277151-400	P140	5-5	277500P40	P138	1-4	277500P40	P138	1-4
228-16557	P106	3-5	257016B48	P141	1-4	257214-16F	P142	3-2	257468-64	P144	4-3	277153-400	P141	5-1	277153-400	P141	5-1	277502P15	P139	1-1	277502P15	P139	1-1
228-16577	P105	3-2	257016B56	P141	1-4	257215-16F	P142	3-3	257468-64	P142	4-2	277-112	P28	3-6	277-112	P28	3-6	277502P15	P179	1-5	277502P15	P179	1-5
228-16755	P105	3-2	257018A56	P142	1-1	257216-16F	P143	3-1	257485-40	P145	4-1	277000	P26	3-7	277000	P26	3-7	277504R30	P138	1-2	277504R30	P138	1-2
228-16755	P106	3-5	257018B56	P144	1-2	257220-16F	P143	3-3	257485-48	P145	4-1	277004	P216	6-2	277004	P216	6-2	277504R40	P138	1-2	277504R40	P138	1-2
228-16953	P105	3-3	257018B56	P141	1-5	257221-16F	P143	3-2	257486-56	P145	4-2	277005	P216	5-2	277005	P216	5-2	277504R400	P140	1-4	277504R400	P140	1-4
228-16953	P106	3-5	257018B56-N	P179	4-1	257221-16F	P143	3-3	257486-64	P145	4-2	277006	P216	8-2	277006	P216	8-2	277504R50	P138	1-2	277504R50	P138	1-2
228-17050	P107	3-1	257018B64	P144	1-2	257221-16F	P143	3-3	257491-60	P143	4-4	277006/A	P216	8-2	277006/A	P216	8-2	277504R50	P138	1-3	277504R50	P138	1-3
228-17159	P107	3-1	257018B64	P141	1-5	257222-16F	P143	3-4	257499-3200	P193	1-4	277007	P216	5-3	277007	P216	5-3	277504R60	P138	1-3	277504R60	P138	1-3
228-20302	P16	3-6	257018B64.H	P179	4-																		

品号 PART NO.	页数 PAGE	行数 LINE
277516R60	P140	1-1
277517R40	P139	1-5
277518R40	P140	1-3
277519R40	P179	2-3
277520012	P41	4-2
277520013	P41	4-3
277524T50	P140	1-2
277524T60	P140	1-2
279-112	P29	1-6
279-113/1	P28	4-3
282188	P187	1-3
290-112	P29	1-4
290-113	P29	1-2
290-113SP	P28	4-4
2A000600000	P25	4-3
2A0008000009	P25	4-4
2A0009000009	P27	4-1
2A0010000009	P26	4-4
2A0078	P27	4-6
2A0081	P26	2-1
2A0082	P26	2-2
2B0010	P27	1-1
2B0010000019	P27	1-2
2Q0018B56D	P145	1-3
2Q0018B64D	P145	1-3
3		
3008021	P185	3-2
3008025	P186	2-2
301006	P27	1-4
301008	P27	1-3
301035	P27	1-6
301036	P27	1-5
301138	P49	4-5
30119001	P18	2-6
30119006	P18	3-6
30119008	P18	3-4
30119009	P18	3-5
30119010	P18	3-7
30119013	P18	4-6
30119014	P18	4-5
30119020	P18	3-1
301A	P62	1-1
3021060	P38	2-5
3021061	P38	2-6
3021109	P36	2-2
3021109.SH	P36	2-2
3021111	P36	2-3
3021111.SH	P36	2-3
30219001	P18	2-7
30219002	P18	1-7
30219003	P18	4-3
30219004	P18	4-4
30219008	P18	4-1
30219009	P18	4-2
3027092	P163	4-4
3027092	P195	1-1
3027095	P163	4-4
3027095	P195	1-1
3027140	P163	4-5
3027140	P195	1-2
3027143	P163	4-5
3027143	P195	1-2
3027143.A	P163	4-5

品号 PART NO.	页数 PAGE	行数 LINE
3027143.A	P195	1-3
3028015	P163	1-6
3028016	P163	1-6
302807-0-10	P29	4-3
302808-0-10	P28	3-5
302865-0-11	P29	4-4
3029019	P163	2-5
303-65407	P11	3-2
303131	P49	4-6
303360	P27	2-6
303363	P27	2-7
30421	P35	4-5
304291A	P49	4-3
305-00300	P11	3-1
305266	P28	2-1
305267	P28	2-2
3052707016	P52	4-3
3052707020	P52	4-2
3052733009	P52	4-4
3052733010	P52	4-4
3052733020	P52	4-4
3052737021	P52	4-1
306394	P26	4-5
308002A	P49	4-4
308026-91	P27	3-2
308030	P27	3-1
308118	P27	1-7
308308	P27	2-1
308503	P28	2-3
308594	P28	2-5
308595	P28	2-4
3100512	P37	4-4
3100513	P37	4-3
3101026	P36	1-1
3101028	P37	2-3
3101465	P37	2-2
31015001	P187	4-1
3101633	P36	1-2
3101633[HSS]	P36	1-2
3101699	P38	1-3
3101700	P38	1-4
3101801	P37	4-1
3101802	P37	4-2
31019006	P18	1-3
3106000	P190	2-6
3107273	P163	4-1
3107274	P163	4-1
3108002	P162	1-2
3108003	P162	1-3
3108130	P159	1-1
3108131	P159	1-1
3108132	P159	1-1
3108133	P185	1-1
3108134	P159	1-2
3108134(厚舌)	P185	1-2
3108134.H	P185	1-2
3108134.N	P185	1-3
3108134D	P185	1-3
3108135	P185	1-1
3108136	P185	4-3
3108140-NS	P185	3-4
3108141-N	P185	3-4
3108142-LN	P185	1-4

品号 PART NO.	页数 PAGE	行数 LINE
3109000	P160	2-3
3109000	P160	2-4
3109000	P190	2-5
3109001	P160	3-3
3109001	P160	3-4
3109002	P160	2-5
3109003	P160	3-5
3109020	P161	2-1
3109021	P161	3-1
3109022	P161	2-1
3109024	P162	2-2
3109025	P162	3-2
3109111	P198	2-4
3109112	P198	2-4
3109200	P230	3-2
3109201	P230	4-2
3109210	P230	4-2
3109300	P230	1-3
3109302	P230	1-3
3109306	P230	1-3
3109310	P230	2-2
3110037	P37	2-4
3110038	P36	1-3
3112005	P38	3-5
3112006	P38	3-6
3117124	P162	4-4
3117126	P162	4-4
3118023	P186	2-5
3118025	P162	1-4
3118026	P162	1-4
3119020	P162	2-3
3119021	P162	3-3
3120015	P37	2-5
3120016	P36	1-4
3139200	P230	3-2
3150426	P37	2-6
315507-0-00	P28	4-2
3158006	P185	4-1
3158012	P185	4-2
3158082	P163	1-4
3158094	P163	1-3
3159012	P163	2-3
3159019	P163	2-2
3159034	P163	2-2
3159034	P163	2-3
3159034/3159012	P190	3-5
3159037	P163	3-2
3159037	P190	3-6
32-2047-1-001	P39	4-7
32-2047-1-002[A]	P39	4-6
320-20505	P15	2-6
320-39604	P209	1-1
320-40917	P209	3-1
320-40917#07	P209	2-3
320-49800	P209	3-2
3201062	P36	1-5
32016107	P15	2-3
32018012	P15	2-1
32018509	P15	2-8
32020703	P15	2-2
32020919	P15	1-8
32023210	P15	2-5
32023319	P15	2-4

品号 PART NO.	页数 PAGE	行数 LINE
32062101	P45	4-1
32062200	P45	4-1
32062309	P45	4-1
32062408	P45	4-1
32062507	P45	4-1
32062606	P45	4-1
32062705	P45	4-1
32062804	P45	4-1
32062903	P45	4-1
32063000	P45	4-1
32063109	P45	4-1
32063208	P45	4-1
32063307	P45	4-1
32063406	P45	4-1
32063505	P45	4-1
3207151	P159	4-3
3207156	P160	4-2
3207157	P160	4-2
3208026	P186	2-3
3208093	P186	2-4
3208094	P186	2-4
3208097	P186	1-3
3208103	P159	1-3
3208108	P160	1-2
3208109	P160	1-2
3209000	P159	3-5
3209001	P159	2-1
3209001	P159	2-5
3209002	P190	3-2
3209003	P190	3-1
3209004	P159	3-3
3209005	P159	2-3
3209006	P190	3-4
3209007	P190	3-3
3209008	P159	3-4
3209008	P160	3-1
3209009	P159	2-4
3209009	P160	2-1
3209064	P159	3-2
3209064	P160	3-2
3209065	P159	2-2
3209065	P160	2-2
3209080	P159	3-1
3209100	P198	2-5
3209101	P159	5-5
3209102	P159	5-4
3209106	P198	3-1
3209107	P159	5-6
3209107	P160	5-1
3209107	P160	5-2
3209108	P160	5-2
3209311	P230	1-2
3209312	P230	1-2
32104	P44	3-2
32203A	P44	3-4
32204B	P44	3-5
32212	P44	3-3
32359	P227	5-2
32655	P226	4-3
32656	P227	5-2
32666	P183	3-5
32667	P183	3-5
32671	P183	3-2

品号 PART NO.	页数 PAGE	行数 LINE
32672	P183	3-2
32673	P183	3-2
3268014	P186	2-1
32706	P37	3-6
327WF-001	P39	4-2
32807	P226	1-4
32807	P228	1-1
32810	P227	1-2
32811	P227	1-2
32813	P228	1-1
32813	P228	3-1
32914	P36	4-3
32914-7	P36	4-4
33059	P228	4-1
33089	P228	5-1
33353(32678)	P183	4-5
33353A(4mm)	P184	1-1
33353A(5mm)	P184	1-1
33541	P184	3-3
33545	P184	3-4
340406	P27	3-3
340468	P27	3-4
34392	P226	2-3
34392	P227	2-1
34392	P227	2-3
34392	P227	2-4
34392	P228	2-1
34393	P227	2-2
34393	P227	2-3
34393	P227	2-4
34519	P227	1-3
34544	P227	5-1
34566	P183	3-3
34584	P227	1-3
34584	P227	5-2
34598	P184	1-2
34614	P226	1-4
34615	P226	1-4
34616	P226	2-3
34617	P227	1-3
34618	P226	1-4
34618	P227	1-3
34619	P226	2-3
34730	P227	1-3
34749	P227	1-3
34749A	P35	2-2
34749EL	P35	2-3
34893	P183	3-1
34894	P183	3-1
350018-91	P27	4-3
350024	P27	4-2
350081	P28	1-4
350083	P28	1-5
3501026	P36	1-7
3501032	P37	2-7
3501534	P37	3-3
3501535	P37	3-2
3501596	P37	3-4
3501597	P37	3-1
350218	P28	1-1
350218[HSS]	P28	1-1
350220	P27	4-7

品号 PART NO.	页数 PAGE	行数 LINE
350220.SH	P27	4-7
350326	P27	4-5
350452-0-00	P28	4-7
350453-0-00	P28	4-8
3507000-N	P161	4-3
3507002-N	P161	4-4
3507050-N	P161	4-5
3507052-N	P161	4-6
3507052-N	P163	4-3
3507054-N	P162	4-1
3507060	P162	4-5
3507064	P162	4-6
3507064	P163	4-1
3507064	P163	4-2
3507108	P162	4-2
3507111	P162	4-3
3508000	P161	1-3
3508001	P161	1-4
3508002	P161	1-5
3508003	P161	1-6
3508008	P185	3-5
3508087	P185	3-3
3508098	P162	1-5
3508099	P162	1-6
3508100	P163	1-1
3508101	P163	1-2
3508104	P162	1-1
3509004	P161	2-2
3509004	P161	2-3
3509004	P162	2-1
3509005	P161	3-2
3509005	P161	3-3
3509005	P162	3-1
3509036	P162	2-5
3509036	P163	2-1
3509037	P162	3-4
3509037	P163	3-1
3509039	P162	2-4
3509320	P230	2-2
351233	P27	2-5
351234A	P27	2-4
35253	P228	1-2
35254	P228	2-2
35285		



品号 PART NO.	页数 PAGE	行数 LINE
400-46301	P169	1-1
400-46302	P169	1-1
400-46303	P169	1-1
400-46304	P169	1-1
400-46305	P169	1-1
400-46306	P169	1-1
400-46314	P196	2-1
400-46315	P196	2-1
400-46316	P196	2-1
400-46317	P196	2-1
400-46318	P196	2-1
400-46319	P196	2-1
400-50011	P106	2-5
400-53705	P106	2-4
400-61270	P105	2-1
400-61270	P105	2-4
400-61271	P105	2-1
400-61271	P105	2-4
400-61272	P105	2-2
400-61272	P105	2-5
400-61274	P105	2-2
400-61274	P105	2-5
400-61276	P105	2-3
400-61276	P105	2-5
400-61277	P105	2-3
400-61277	P106	2-1
400-61278	P106	2-1
400-61280	P106	2-2
400-61289	P106	2-2
400-71909	P106	3-4
400-71911	P106	2-4
400-71912	P107	2-2
400-71913	P106	2-3
400-71914	P106	2-3
400-76709	P16	3-3
40012685	P12	2-4
40017611	P12	2-3
40019883	P11	1-3
40019884	P11	1-4
40020224	P11	1-3
40025949	P16	4-1
40029004	P15	3-3
40030932	P82	2-1
40030933	P82	2-1
40030934	P82	2-1
40033160	P16	3-4
40034923	P15	1-7
40038091	P9	3-2
40044189	P12	3-3
40044190	P12	4-2
40050588	P12	3-4
40050589	P12	3-7
40068380	P10	3-2
40068381	P10	3-3
40086274	P13	3-3
40086277	P13	4-1
40089755	P12	3-6
40091822	P16	4-6
40091839	P16	4-5
401-72486	P12	1-6
401-72487	P12	1-5
40115002	P172	1-1
40115382	P208	5-3

品号 PART NO.	页数 PAGE	行数 LINE
40115665	P45	3-3
40115666	P45	4-2
40115667	P45	4-2
40115668	P45	4-2
40115669	P45	4-2
40115670	P45	4-2
40127154	P11	4-2
40127155	P11	4-3
40155651	P9	3-3
40169705	P16	2-4
40177341	P13	1-6
40177342	P170	4-5
40177343	P170	4-6
40179344	P13	1-7
40187740	P11	4-1
40194360	P12	1-4
40194361	P12	1-3
40195289	P11	4-5
40195311	P16	2-3
40195552	P11	4-6
40196346	P14	1-4
40200018	P11	4-4
40208387	P14	1-5
40211454	P11	4-7
40215002	P171	2-1
4021900100	P19	1-3
4021900500	P19	1-4
40219007	P19	1-5
40219009	P68	4-2
40219010	P68	4-3
40219011	P68	4-1
40219012	P68	4-4
40219013	P68	4-5
40220191	P16	2-5
40222677	P16	2-6
40235075	P16	2-7
40237599	P13	3-2
40239184	P12	1-1
40239186	P12	1-2
40315025	P172	1-2
40315033	P172	1-1
40319007	P19	2-3
40319008	P19	2-4
40515001	P172	2-1
40515007	P172	1-3
40619003	P18	4-7
40619004	P18	4-8
40619005	P19	1-2
40719301	P19	3-2
40719302	P19	3-1
408-9101-01-B	P9	3-5
408-9102-01-A	P9	2-3
40901005	P171	3-1
4091900100	P19	2-1
40919003	P19	2-2
410295	P33	2-4
411088	P33	3-7
412585	P33	2-7
412749	P33	2-3
41315006	P171	2-2
41315007	P171	2-3
4131900200	P19	1-6
4131900300	P19	1-7

品号 PART NO.	页数 PAGE	行数 LINE
41709002	P19	2-8
4170900300	P19	2-7
41715002	P172	2-2
41715005	P172	2-2
41815011	P51	1-2
41815012	P51	1-1
41815015	P51	1-4
41815015	P171	4-1
41815211	P171	3-2
41815601	P51	2-1
41815612	P172	1-4
41815614	P51	1-1
41815615	P51	1-1
41815617	P51	1-1
41815618	P51	1-1
42115001	P171	4-2
42115002	P171	4-2
42115003	P171	4-2
42115004	P171	4-2
42115005	P171	4-2
42115006	P171	4-2
42115007	P171	4-2
42215502	P51	1-2
42305	P33	2-2
42309	P33	2-1
42515001	P51	1-5
4309200	P229	7-1
4309201	P229	6-1
4309300	P229	4-1
4309320	P229	4-2
46-1001-5-289	P33	4-5
46-1125-5-000	P33	4-6
46002	P44	2-5
46251	P44	2-2
46377	P55	2-2
47892	P66	1-2
47968	P66	1-5
48119003	P20	2-3
48119004	P20	2-4
4AG0030104	P23	1-7
4AG0050103	P23	1-6
4AG0050104	P22	4-7
4SS0330111	P23	3-3
4SS0330115	P23	3-4
4US0400121	P23	3-6
4US0400125	P23	3-5

品号 PART NO.	页数 PAGE	行数 LINE
5		
5000261	P38	1-5
5000262	P38	1-6
502670	P33	3-8
51009080	P7	3-1
5100912	P7	3-2
52-275	P22	2-1
52-288	P22	2-2
52006650	P42	2-2
520A007(1/4)	P187	3-1
520A007(3/16)	P187	3-1
520A007(5/16)	P187	3-1
520A007(7/32)	P187	3-1
520A007(9/32)	P187	3-1
520A020	P40	2-6
5210TP0015	P176	1-3
5210TP04A33	P175	4-4

品号 PART NO.	页数 PAGE	行数 LINE
5210TP04A43	P175	4-5
5210TP04A53	P176	1-1
5210TP04A63	P176	1-2
5210TP05C52	P176	2-2
5210TP45D53	P176	2-5
5210TPB3022A	P175	2-4
5210UL604882	P212	2-2
5210UL604883	P212	2-2
5212LL0001	P212	3-3
5212LL0002	P212	3-3
5212LL603884	P212	3-1
5212LL603884	P212	3-2
5212LL604885	P212	3-1
5212TP0033	P176	3-1
5212TP0035	P176	1-4
5212UL0002	P212	2-4
5212UL0003	P212	2-4
5212UL603880	P212	2-1
5212UL603880	P212	2-3
5212UL603881	P212	2-1
5212UL603881	P212	2-3
5212UL603886	P212	4-1
5220DF42562	P130	3-4
5220DF85561	P130	3-3
5220DF85561	P130	3-5
5220DFL1561	P131	3-1
5220FD42562	P130	2-4
5220FD85561	P130	2-3
5220FD85561	P130	2-5
5220FDL1561	P131	2-1
5220NC00400	P130	5-5
5220NC00400	P131	5-1
5220NC00480	P130	5-5
5220NC00480	P131	5-1
5220NC00561	P130	5-3
5220NC00561	P130	5-4
5220NC00561	P130	5-6
5220NC00561	P131	5-2
5220NC00641	P130	5-3
5220NC00641	P130	5-4
5220NC00641	P130	5-6
5220NC00641	P131	5-2
5220PF42561	P130	4-4
5220PF85560	P130	4-3
5220PF85641	P130	4-3
5220TP00564	P176	4-4
5220TP00566	P176	4-4
5220TP00568	P176	4-2
5220TP00646	P176	4-2
5220TP03563	P177	1-5
5220TP11480	P177	1-1
5220TP11560	P177	1-1
5220TP42562	P130	1-4
5220TP42642	P130	1-4
5220TP85400	P130	1-5
5220TP85480	P130	1-5
5220TP85560	P130	1-3
5220TP85560	P130	1-6
5220TP85561	P130	1-3
5220TP85640	P130	1-6
5220TP85641	P177	1-5
5220TPL1400	P131	1-1

品号 PART NO.	页数 PAGE	行数 LINE
5220TPL1480	P131	1-1
5221TP60600	P177	1-3
5222PF85400	P130	4-5
5222PF85480	P130	4-5
5222PF85560	P130	4-6
5222PF85640	P130	4-6
5222PFL1400	P131	4-1
5222PFL1480	P131	4-1
5222PFL1560	P131	4-2
5222PFL1640	P131	4-2
5222TP03400	P177	1-4
5222TP03480	P177	1-4
5222TP03560	P177	1-4
5222TP03640	P177	1-4
5222TP11400	P176	4-5
5222TP13562	P176	4-3
5222TPL1560	P131	1-2
5222TPL1640	P131	1-2
5240PF0109	P23	1-2
5240PF0709	P23	4-2
540741	P33	4-1
540760	P19	4-6
540760	P33	4-2
542515-001T	P78	2-1
544533	P33	3-6
548205	P221	5-1
548207	P221	6-2
548231	P221	6-1
548232	P221	5-2
548752	P48	1-2
548753	P48	1-2
548754	P48	1-2
548755	P48	1-2
548756	P48	1-2
548757	P48	1-2
548758	P48	1-2
548759	P48	1-2
548760	P48	1-2
548761	P48	1-2
548762	P48	1-1
548763	P48	1-1
548764	P48	1-1
548765	P48	1-1
548766	P48	1-1
548767	P48	1-1
548768	P48	1-1
548769	P48	1-1
548770	P48	1-1
548771	P48	1-1
548804	P46	3-3
548845	P33	3-1
548851	P33	3-2
548865	P33	3-4
550449	P33	2-6
5509031310	P39	3-3
557 1677	P46	1-1
557000602A	P203	1-3
557000602A	P203	2-4
557000605	P203	1-2
557000611	P203	1-4
557000611	P203	2-5
557000614	P203	1-1
557002035	P203	1-5

品号 PART NO.	页数 PAGE	行数 LINE
557002872	P203	2-1
557002872	P203	3-1
557002872A	P203	3-3
557003243	P203	3-2
557003398	P203	2-2
558 2406	P46	3-4
558 2407	P46	3-4
558 2408	P46	3-4
558 2409	P46	3-4
558 2410	P46	3-4
558 2411	P46	3-4
558 2412	P46	3-4
558 2413	P46	3-4
558 2414	P46	3-4
558 2551	P46	1-2
558 2561	P46	1-3
558 2562	P46	1-4
558 2562/M	P46	1-4
558 2563	P46	1-5
558 2564	P46	2-1
558 2564/M	P46	2-1
558 9011	P7	3-5
558002876K	P203	2-3
559032010	P39	3-2

品号 PART NO.	页数 PAGE	行数 LINE
6509013	P158	3-5
6509103	P158	5-5
6509300	P229	4-1
66878	P66	1-4
680330420	P42	2-5
68053	P163	5-4
68095	P163	3-3
68096	P163	2-4
68121	P36	2-6
68121.SH	P36	2-6
68123	P229	3-2
68124	P229	4-3
68184	P36	2-7
68184.SH	P36	2-7
68185	P36	2-4
68185[K]	P36	2-5
68217	P229	1-3
68217/ZJ	P229	1-3
68218	P229	2-2
68490	P163	1-5
68491	P163	1-6
68509	P36	3-1
68539	P66	1-6
68553	P163	5-4
68559	P163	1-5
68560	P163	1-5
68560	P163	1-6
6E	P69	1-1
6EW	P70	1-1
6EW(KO)	P70	1-1
6KM	P69	2-1
6KM(N)	P69	2-1
6KMW	P70	2-1
6KMW(N)	P70	2-1
7		
70001791	P13	3-1
70001861	P10	2-4
70004083	P13	3-4
7024029	P52	1-6
7024029-1	P52	1-6
71CL 1	P68	2-6
71CL 1 1/2	P68	3-4
71CL 1 1/4	P68	3-2
71CL 1 1/8	P68	3-1
71CL 1 3/8	P68	3-3
71CL 1/2	P68	1-6
71CL 1/4	P68	1-2
71CL 1/8	P68	1-1
71CL 11/16	P68	2-3
71CL 3/4	P68	2-4
71CL 3/8	P68	1-4
71CL 5/16	P68	1-3
71CL 5/8	P68	2-2
71CL 7/16	P68	1-5
71CL 7/8	P68	2-5
71CL 9/16	P68	2-1
73436	P66	1-1
746-60689	P7	1-6
746-60689.SH	P7	1-6
746-60690	P7	1-5
746-60690.SH	P7	1-5
746-60691	P7	2-2
746-60691.SH	P7	2-2

品号 PART NO.	页数 PAGE	行数 LINE
746-60692	P7	2-1
746-60692.SH	P7	2-1
74H01-008G01(1/8)	P187	1-5
74H01-010G01(5/32)	P187	1-6
7E	P69	1-1
7EW	P70	1-1
7EW(KO)	P70	1-1
7KM	P69	2-1
7KMW	P70	2-1
7KMW(N)	P70	2-1
8		
801-1	P63	1-1
801-2	P63	1-2
802-1	P63	1-3
802-2	P63	1-4
80C1-59	P54	1-1
80C1-59[4A]	P54	1-1
80C1-59[5A]	P54	1-1
80C1-61	P54	1-2
80C125-21	P54	1-3
81000669	P40	3-6
81000670	P40	3-7
82000138290	P52	2-3
82000170290	P52	2-3
82000171290	P52	2-3
82000172290	P52	2-3
82115201	P187	2-5
82119201	P20	2-5
82119202	P20	2-6
8330240201	P38	4-5
84612306	P60	3-4
84619001	P55	1-3
84619002	P60	3-3
854901001	P42	2-6
870244	P42	2-7
891264-UVZ	P51	3-1
8E	P69	1-1
8E(TFL)	P69	3-1
8EW	P70	1-1
8EW(KO)	P70	1-1
8KM	P69	2-1
8KMW	P70	2-1
9		
901-1	P63	2-1
901-2	P63	2-2
90166	P184	4-5
90167	P184	4-5
90425	P229	2-1
90529	P229	1-1
90556	P186	1-4
90557	P186	1-4
91-014046-05	P25	1-3
91-140726-01	P24	4-4
91-141911-01	P24	4-5
91-164727-X4	P197	2-1
91-165505-05	P25	1-4
91-188294-05	P24	4-2
91-188303-05	P24	4-3
91-189140-05	P24	4-1
91-263139-05	P25	2-2
91-263294-05	P25	2-1
91-263348-05	P25	2-3
91-264240-05	P25	1-2

品号 PART NO.	页数 PAGE	行数 LINE
91-264338-15	P25	1-1
91-500397-05	P25	1-6
91-500399-05	P25	1-5
91-710004-04/002	P197	2-2
91-710004-04/005	P197	2-3
91-710004-04/006	P197	2-4
911-1/933-1	P63	2-3
911-2/933-2	P63	2-4
91764	P186	1-5
91765	P186	1-5
928530-2-00	P29	4-7
928531-2-00	P29	4-6
93170	P160	1-3
93171	P160	1-3
93172	P160	1-3
93251	P198	4-5
93252	P198	4-5
93253	P198	4-5
93257	P198	4-6
93351	P159	5-1
93351	P160	5-3
93351	P161	5-3
93352	P159	5-1
93352	P159	5-3
93352	P160	5-3
93352	P161	5-1
93352	P161	5-4
93352	P162	5-5
93353	P159	5-1
93353	P160	5-3
93356	P161	5-5
93356	P162	5-6
93357	P159	5-2
93357	P160	5-5
93357	P161	5-2
93357	P161	5-6
93357	P162	5-2
93357	P162	5-4
93357	P163	5-1
93357	P163	5-3
93358	P160	5-4
93358	P160	5-6
93358	P161	5-2
93358	P162	5-1
93358	P162	5-3
93358	P162	5-4
93358	P163	5-2
93394	P190	4-1
93395	P190	4-2
93396	P190	4-3
93397	P190	4-4
93410	P184	4-3
93417	P184	4-3
93659	P230	3-1
94210	P185	4-5
94211	P185	4-5
94212	P185	4-5
94217	P159	4-4
94281	P185	4-4
94283	P159	1-4
94417	P37	4-6
94480	P229	1-1
94480	P229	1-2

品号 PART NO.	页数 PAGE	行数 LINE
94480	P230	1-2
94800	P184	4-4
94801	P159	1-6
94801	P160	1-5
94801-L-DC	P184	4-4
94801-L2	P185	1-5
94801-L2-05	P185	2-1
94801-LC	P185	2-2
94801B	P185	2-5
94801C	P185	2-3
94801C-L5	P185	2-3
94801D	P185	2-4
94801D-L5	P185	2-4
94802	P160	1-6
94802-L5	P185	3-1
94901	P186	1-5
94902	P161	1-2
94909	P161	4-2
95-774464-25	P25	2-7
95-774853-05	P25	2-5
95-774855-05	P25	2-4
95-774855-05.L	P25	2-4
95-774856-05(0.3mm)	P25	2-6
95-774856-05.A(0.5mm)	P25	2-6
95-774856-05.L(0.4mm)	P25	2-6
95085	P160	1-1
95085	P161	1-2
95089	P160	4-1
95089	P161	4-2
95234	P159	1-5
95234	P161	1-1
95238	P159	4-5
95238	P161	4-1
95260	P186	1-1
95261	P186	1-2
95262	P186	1-2
95276	P37	2-1
95277	P36	1-6
95278	P186	3-1
95279	P186	3-1
95493	P160	1-4
95580	P195	1-4
95581	P195	1-4
95582	P195	1-4
95587	P159	4-6
95723	P229	3-1
95723	P230	4-1
96-700535-05	P24	2-5
96-700591-05	P24	2-6
980478-14	P51	3-4
980478-16	P51	3-4
980478-19	P51	3-4
980478-30	P51	3-4
981-886	P19	4-1
981-888	P19	4-2
981-889	P19	4-3
9E	P69	1-1
9EW	P70	1-1
9EW(KO)	P70	1-1
9KM	P69	2-1
9KMW	P70	2-1
A		
A-113(6)	P54	3-1

品号 PART NO.	页数 PAGE	行数 LINE
A-113(R)	P54	2-4
A-90-3	P24	3-6
A-90-7	P24	3-7
A105-21000	P41	1-3
A105-31000	P41	1-4
A141D676H01	P23	4-5
A4142655000	P9	4-7
A702	P32	2-1
A703	P32	2-2
AB6110-0C	P38	4-4
ABLE/HB-90-L	P40	3-4
ABLE/HB-90-S	P40	3-5
AE-12080A	P52	3-3
AF60874	P130	3-1
AF60875	P130	3-2
AN02	P30	2-6
AN12	P30	2-7
AN13	P30	2-8
B		
B	P25	3-6
B[HSS]	P25	3-6
BOM-101(4)	P55	2-3
BOM-101(4)[4A]	P55	2-3
BOM-80	P55	2-2
B1-1	P63	2-3
B1-2	P63	2-4
B1103-380-B00	P107	1-4
B1103-380-C00	P107	1-4
B1103-380-D00	P107	1-5
B1103-380-E00	P107	1-5
B1103-380-F00	P107	1-6
B1103-380-H00	P107	1-6
B1103-380-K00	P108	1-1
B1103-380-L00	P108	1-1
B1103-382-000	P108	1-6
B1103-481-F00	P107	1-3
B1109-027-AA0	P171	1-2
B1111038000	P171	1-1
B1130-026-000	P10	3-4
B1131-026-000	P10	3-5
B1136-357-A00	P169	1-2
B1136-357-B00	P169	1-2
B1136-357-C00	P169	1-2
B1137-352-000	P169	1-3
B1137-354-000	P169	1-4
B1190-522-5/64	P168	3-3
B1190-522-7/32	P168	3-1
B1190-522-S00	P168	3-2
B1190-522-T00	P168	3-2
B1190-522-U00	P168	3-3
B1190-522-V00	P168	3-3
B1190-522-X00	P168	3-1
B1190-522-Y00	P168	3-1
B1190-522-Y0B	P168	3-3
B1190-530-D00	P168	3-4
B1190-530-E00	P168	3-5
B1190-530-F00	P168	4-1
B1190-530-G00	P168	4-1
B1190-530-H00	P168	4-2
B1190-530-J00	P168	4-3
B1190-530-M00	P168	4-3
B1237-373-000	P11	3-5
B1239-372-000	P209	3-5

品号 PART NO.	页数 PAGE	行数 LINE
B1239-373-000	P209	3-6
B1241-373-000	P83	2-1
B1241-373-0B0	P83	2-1
B1241-377-000	P84	1-1
B1241-377-0B0	P84	1-1
B1402-528-BA0-A	P105	4-4
B1402-528-BA0-A	P105	5-1
B1402-528-BA0-A	P106	4-4
B1402-528-BA0-A	P106	5-4
B1402-528-CA0-A	P105	4-4
B1402-528-CA0-A	P105	5-1
B1402-528-CA0-A	P106	4-4
B1402-528-CA0-A	P106	5-4
B1402-528-DAL-A	P105	4-5
B1402-528-DAL-A	P106	4-5
B1402-528-DAR-A	P105	5-2
B1402-528-DAR-A	P106	5-5
B1402-528-FAL-A	P105	4-5
B1402-528-FAL-A	P106	4-5
B1402-528-FAR-A	P105	5-2
B1402-528-FAR-A	P106	5-5
B1402-528-HAL-A	P105	4-5
B1402-528-HAL-A	P106	4-5
B1402-528-HAR-A	P105	5-2
B1402-528-HAR-A	P106	5-5
B1402-528-KAL-A	P106	4-1
B1402-528-KAL-A	P107	4-1
B1402-528-KAR-A	P106	5-1
B1402-528-KAR-A	P107	5-1
B1402-528-LAL	P106	4-1
B1402-528-LAL	P107	4-1
B1402-528-LAR	P106	5-1
B1402-528-LAR	P107	5-1
B1402-528-MAL	P106	4-2
B1402-528-MAL	P107	4-2
B1402-528-MAR	P106	5-2
B1402-528-MAR	P107	5-2
B1402-528-NAL	P106	4-2
B1402-528-NAL	P107	4-2
B1402-528-NAR	P106	5-2

品号 PART NO.	页数 PAGE	行数 LINE
B2423-280-00A	P80	2-1
B2423-280-00A	P81	1-1
B2423-280-00A	P81	2-1
B2423-280-00A	P82	1-1
B2423-280-00A	P82	2-1
B2423-280-00A	P83	1-1
B2423-280-00A	P86	1-1
B2423-280-00A	P86	2-1
B2423-280-00B	P79	2-1
B2423-280-00B	P80	1-1
B2423-280-00B	P80	2-1
B2423-280-00B	P81	1-1
B2423-280-00B	P81	2-1
B2423-280-00B	P82	1-1
B2423-280-00B	P82	2-1
B2423-280-00B	P83	1-1
B2423-280-00B	P86	1-1
B2423-280-00B	P86	2-1
B2423-280-00C	P79	2-1
B2423-280-00C	P80	1-1
B2423-280-00C	P80	2-1
B2423-280-00C	P81	1-1
B2423-280-00C	P81	2-1
B2423-280-00C	P82	1-1
B2423-280-00C	P82	2-1
B2423-280-00C	P83	1-1
B2423-280-00C	P86	1-1
B2423-280-00C	P86	2-1
B2423-280-00D	P79	2-1
B2423-280-00D	P80	1-1
B2423-280-00D	P80	2-1
B2423-280-00D	P81	1-1
B2423-280-00D	P81	2-1
B2423-280-00D	P82	1-1
B2423-280-00D	P82	2-1
B2423-280-00D	P83	1-1
B2423-280-00D	P86	1-1
B2423-280-00D	P86	2-1
B2423-280-00E	P79	2-1
B2423-280-00E	P80	1-1
B2423-280-00E	P80	2-1
B2423-280-00E	P81	1-1
B2423-280-00E	P81	2-1
B2423-280-00E	P82	1-1
B2423-280-00E	P82	2-1
B2423-280-00E	P83	1-1
B2423-280-00E	P86	1-1
B2423-280-00E	P86	2-1
B2423-280-00F	P86	1-1
B2423-280-00F	P86	2-1
B2423-280-00G	P86	1-1
B2423-280-00G	P86	2-1
B2424-210-000	P13	2-3
B2424-210-000	P82	1-1
B2424-210-000	P82	2-1
B2424-210-000	P83	1-1
B2424-210-000	P86	1-1
B2424-210-000	P86	2-1
B2424-210-000(Heavy)	P81	2-1
B2424-210-A00	P13	2-6
B2424-280-000	P13	1-5
B2424-280-000	P79	2-1
B2424-280-000	P80	1-1
B2424-280-000	P80	2-1
B2424-280-000	P81	1-1
B2424-280-000	P81	2-1

品号 PART NO.	页数 PAGE	行数 LINE
B2424-280-000/M	P13	1-5
B2425-210-000	P82	1-1
B2425-210-DAA	P82	1-1
B2425-210-DAB	P82	1-1
B2425-211-DAB	P83	1-1
B2425-215-P00	P83	1-1
B2425-221-DAA	P83	1-1
B2426-210-00A	P82	1-1
B2426-210-00A	P82	2-1
B2426-210-00A	P83	1-1
B2426-210-00A	P170	3-3
B2426-210-00B	P82	1-1
B2426-210-00B	P82	2-1
B2426-210-00B	P83	1-1
B2426-210-00B	P170	3-3
B2426-210-00C	P170	3-4
B2426-210-00D	P170	3-3
B2426-210-00F	P170	3-4
B2426-210-00F.D2.6	P170	3-3
B2426-280-000	P79	2-1
B2426-280-000	P80	1-1
B2426-280-000	P80	2-1
B2426-280-000	P170	3-5
B2426-280-000.D2.6	P170	3-5
B2426-280-00B	P79	2-1
B2426-280-00B	P80	1-1
B2426-280-00B	P80	2-1
B2426-280-00B	P170	3-5
B2426-280-00C	P79	2-1
B2426-280-00C	P80	1-1
B2426-280-00C	P80	2-1
B2426-280-00C	P170	3-5
B2702-377-000	P84	1-1
B3013-141-H0A	P85	1-1
B4108-352-00B	P9	3-7
B4108-352-00B[L]	P9	3-6
B4108-352-00D	P9	4-1
B4111-804-00A	P10	1-6
B4111-804-00C	P10	1-7
B4111-804-00E	P10	1-8
B4118-804-000	P9	1-7
B4118-804-00C	P9	1-8
B4121-052-A00	P11	2-3
B4121-522-000	P11	2-4
B4121-522-000(W)	P11	2-6
B4121-522-000[HSS]	P11	2-4
B4121-522-000[L]	P11	2-4
B4121-522-000[SKS7]	P11	2-4
B4122-352-00A	P9	2-4
B4145-530-B00	P11	2-5
B4401	P41	1-1
B4471	P41	1-2
B91663-B	P51	3-5
BE-438D(Light)	P76	1-1
BE-438F	P77	1-1
BG127	P32	1-2
BG130D	P32	1-1
BK10F	P32	1-7
BM065-S	P64	1-3
BM148	P64	1-1
BM935	P64	1-4
BM935.G2	P64	1-5
BM935.H	P64	1-6

品号 PART NO.	页数 PAGE	行数 LINE
BM986	P64	1-2
BT113072(10)[4A]	P57	2-4
C		
CL605294	P212	5-1
CR26	P30	4-2
CR26H	P30	3-6
CR26J	P30	3-5
CR336	P30	1-2
CRL03	P30	3-7
CRL03H	P30	3-8
CRL03J	P30	4-1
CRL04H	P30	4-6
CRL04J	P30	4-5
CRL09J	P30	1-1
CRL103	P30	4-3
CRL104	P30	4-4
CRL204	P30	4-7
CT18-1	P31	2-4
CT19	P31	2-3
CT202	P31	2-6
CT202295	P25	3-3
CT203	P31	2-5
CT270-112	P29	2-7
CT270-113/1	P28	3-3
CT276B-112	P29	1-5
CT277-112	P29	3-5
CT277-113	P28	3-7
CT290-112	P29	3-2
CT290-113	P29	1-1
CT3100512	P37	4-5
CT37469	P36	3-5
CT39570	P37	1-2
CTMAS-11012	P11	1-5
CTMAS-11013	P11	1-6
CUT126	P44	3-1
CUT142	P44	2-6
CV-40	P64	1-7
D		
D001	P44	2-7
D095	P145	3-4
D095	P146	3-3
D1206	P152	3-1
D1207	P152	3-2
D1207	P152	3-4
D1215	P151	3-3
D1216	P152	3-3
D1406-038-BA0	P108	4-5
D1603-356	P186	4-4
D1613-380-L00	P108	2-1
D1737	P34	1-3
D2056-772-B0B	P85	2-1
D207	P148	3-1
D207	P148	3-2
D208	P148	3-2
D210	P148	3-1
D2107	P150	3-2
D2401-481-CD0	P15	1-5
D2401-530-D00	P13	1-2
D2402-415-BA0	P12	4-6
D2402-555-BA0	P12	4-4
D2402-555-BAB	P12	4-5
D2404-530-D00	P13	1-3
D2405-481-C00A	P15	1-6

品号 PART NO.	页数 PAGE	行数 LINE
D2405-555-B00B	P12	3-1
D2406-555-B00	P13	1-1
D2406-555-D0H	P12	2-7
D2406-555-D0H/M	P12	2-7
D2408-555-CA0	P13	4-3
D2423-141-E00	P13	3-5
D2424-141-E00	P13	3-6
D2426-282-C00	P170	4-2
D2426-284-M00	P81	2-1
D290	P146	3-2
D3161-555-BA0	P13	4-4
D3216	P149	3-1
D3216	P149	3-3
D3216	P150	3-4
D3216	P151	3-2
D3216	P151	3-4
D3217	P151	3-4
D34901-001	P78	1-1
D390	P189	4-6
D4206	P149	3-2
D4206	P150	3-1
D4206	P150	3-3
D4206	P150	3-3
D4206	P151	3-1
D4207	P149	3-2
D4207	P150	3-3
D4207	P151	3-1
D438	P146	3-1
D438	P146	3-2
D440	P145	3-4
D440	P146	3-3
D440	P146	3-4
D489	P147	3-1
D490	P147	3-2
D502	P147	3-1
D502	P147	3-2
D502	P147	3-3
D502	P147	3-4
D569	P146	3-1
D574	P146	3-4
D575	P145	3-4
D575	P146	3-3
D581	P147	3-1
D582	P147	3-2
D674	P146	3-4
D675	P189	4-6
D684	P146	3-1
D8.15-1	P170	4-1
D9012	P153	2-2
D9012	P154	2-1
D9104	P153	2-1
D9108	P153	2-3
D9112	P153	2-2
D9112	P154	2-1
D9113	P154	2-2
D9117A	P155	2-1
D912	P146	3-2
D9121	P155	2-2
D9123A	P155	2-3
D9313	P154	2-3
D969	P189	4-6
D971	P147	3-3
D972	P147	3-4

品号 PART NO.	页数 PAGE	行数 LINE
DF85209	P130	2-1
DF86108	P130	2-2
DSK25	P40	4-3
DSK27	P40	4-2
DST-05	P8	4-6
DST-06	P8	4-5
DT05	P31	3-2
DT06	P31	3-1
E		
E0215R	P182	4-2
E0216R	P182	4-5
E0217R	P182	4-5
E0225Q	P182	4-3
E0226P	P183	1-1
E0226Q	P183	1-2
E0227Q	P183	1-2
E0235R	P182	4-4
E1524	P152	1-1
E1525	P152	1-1
E1535	P181	2-5
E1623	P183	2-1
E1816	P181	3-2
E1817	P181	3-2
E1825	P181	3-3
E1826	P152	1-2
E1826H	P181	3-4
E1827	P152	1-2
E1828	P152	1-5
E1836L	P181	2-4
E1837	P181	3-5
E1837L	P181	2-4
E1846	P181	4-1
E1847	P181	4-1
E217	P148	1-3
E218	P148	1-4
E219	P148	1-5
E222	P148	1-1
E226	P181	2-3
E229	P148	1-2
E232	P181	2-2
E232.Cr	P181	2-2
E2324P	P181	4-3
E2325P	P181	4-3
E2326P	P181	4-4
E2625P	P182	1-1
E2626P	P150	1-2
E2627P	P182	2-2
E2826P	P182	2-3
E2827P	P182	2-3
E3024	P151	1-4
E3025	P151	1-4
E3326	P152	1-3
E3326P	P182	2-5
E3327	P152	1-3
E3327P	P182	2-5
E3524P	P149	1-2
E3524P	P150	1-3
E3524R	P181	4-5
E3525P	P150	1-3
E3525P	P181	4-2
E3626P	P150	1-1
E3627P	P182	2-1
E3727	P182	2-4

品号 PART NO.	页数 PAGE	行数 LINE
E3816P	P182	1-2
E3817P	P182	1-2
E3826	P151	1-2
E3826-H	P182	1-3
E3826P	P149	1-3
E3826P	P150	1-4
E3826R	P182	1-5
E3827	P151	1-2
E3827P	P149	1-3
E3827P	P150	1-4
E3827R	P182	1-5
E3836	P182	1-4
E3837	P182	1-4
E3846	P151	1-1
E3847	P151	1-1
E3966P	P183	1-3
E3967	P183	1-4
E4124P	P149	1-4
E4124P	P151	1-3
E4125P	P151	1-3
E4326	P182	3-1
E4326P	P149	1-5
E4326P	P150	1-5
E4327	P182	3-1
E4327P	P182	3-1
E4426	P182	3-4
E4426P	P149	1-1
E4426P	P151	1-5
E4427	P182	3-4
E4427P	P151	1-5
E4826	P152	1-4
E4836M	P181	3-1
E5827	P183	2-2
E589F	P180	3-4
E590	P180	3-5
E591B	P180	4-3
E591E	P180	4-1
E591F	P180	4-2
E6024	P182	3-2
E6326	P182	3-3
E6327	P182	

品号 PART NO.	页数 PAGE	行数 LINE
H4259	P150	2-3
H4259	P151	2-1
H442	P146	2-1
H445	P145	2-4
H445	P146	2-2
H4458	P151	2-2
H4459	P151	2-2
H497	P147	2-1
H497	P147	2-4
H500	P147	2-2
H500	P147	2-5
H501	P147	2-3
H974	P189	4-5
HCB05062	P42	3-3
HCD05033	P42	3-4
HE21	P220	4-4
HE21Q	P220	4-2
HE21Q	P220	5-2
HE22	P220	4-5
HE22Q	P220	4-3
HE22Q	P220	5-3
HE22R	P220	5-4
HE28	P220	5-5
HF100[5A]	P55	1-1
HF125[5A]	P55	1-2
HN-5018	P39	2-3
HN-5018N	P39	2-4
HZ2NL1	P43	4-7
HZ2P.L1	P43	4-6
HZ3B42	P43	4-3
HZ4N	P43	4-4
HZ5K.H	P43	4-5
I		
ISP05037	P64	1-9
J		
J1037[HSS]	P34	1-8
J2213[HSS]	P34	1-7
JK-T580-01-28-016	P48	2-1
JK-T580-01-28-017	P48	2-2
JK-T580-01-28-018	P48	2-3
K		
K26-17	P34	3-6
K26-17[K]	P34	3-6
K26-37	P34	3-7
K26-37[K]	P34	3-7
K6-29A	P34	3-4
K6-29A.SH	P34	3-4
K6-29A[HSS]	P34	3-4
K7-44A	P34	3-5
K7-44A.SH	P34	3-5
K7-44A[HSS]	P34	3-5
KA-5	P60	2-1
KE-430D(Heavy)	P75	1-1
KE-430D(Light)	P75	1-1
KE-430D(Medium)	P75	1-1
KE004	P41	1-7
KE019	P40	4-8
KE027-3	P60	3-6
KE027-3.A	P60	3-7
KE029	P40	3-1
KE030	P40	3-2
KE031	P40	3-3
KE043	P40	4-7

品号 PART NO.	页数 PAGE	行数 LINE
KE044	P40	1-4
KE1033[4A]	P57	2-3
KE1045(10)	P56	3-4
KE1045(10)[5A]	P56	3-4
KE1045(8)	P56	3-2
KE1045(8)[4A]	P56	3-2
KE1045(8)[5A]	P56	3-2
KE1045(8)[TC]	P56	3-3
KE1049(8)	P60	2-2
KE1049(8)[4A]	P60	2-2
KE1049(8)[5A]	P60	2-2
KE1056HQ	P50	2-1
KE1057	P38	4-3
KE1116	P61	1-1
KE1117	P61	1-1
KE1144	P50	2-5
KE1145	P50	2-6
KE1168	P41	3-1
KE1169	P41	3-2
KE1170	P41	3-3
KE1171	P57	3-2
KE1171[5A]	P57	3-2
KE134	P50	4-4
KE148(8)	P60	1-1
KE149(8)	P54	1-3
KE149(8)[4A]	P54	1-3
KE149(8)[5A]	P54	1-3
KE1599	P34	4-1
KE1600	P34	4-2
KE1647	P50	2-2
KE1658	P50	3-2
KE168	P40	1-1
KE1697	P34	3-2
KE1698	P34	3-3
KE1711	P44	4-6
KE172(8)	P58	2-3
KE172(8)[4A]	P58	2-3
KE172(8)[5A]	P58	2-3
KE1737	P50	3-4
KE1759J	P42	1-4
KE1768	P43	2-1
KE1769	P43	2-2
KE1801	P50	2-4
KE1819	P42	1-6
KE1824	P61	1-1
KE1875	P50	3-3
KE1971	P42	1-5
KE1984	P34	2-6
KE1985	P34	2-7
KE1986	P42	3-6
KE2179	P41	4-7
KE2266	P34	3-1
KE2275-1	P42	4-1
KE2275-2	P42	4-2
KE2341	P42	1-1
KE2342	P42	1-2
KE242[4A]	P59	1-2
KE2529	P3	2-7
KE2529.G1	P41	4-1
KE263	P66	1-7
KE2635	P54	2-2
KE264	P43	1-3

品号 PART NO.	页数 PAGE	行数 LINE
KE265	P43	1-2
KE266	P66	1-8
KE268(8)[4A]	P59	1-1
KE2695	P57	3-3
KE2706	P3	3-6
KE272	P59	2-3
KE272[4A]	P59	2-3
KE273(8)	P59	3-3
KE273(8)[4A]	P59	3-3
KE277	P67	1-2
KE278	P43	4-1
KE287	P43	4-2
KE291(8)	P60	1-2
KE291(8)[4A]	P60	1-2
KE293	P66	1-9
KE301[4A]	P57	2-1
KE328	P27	4-4
KE430E	P75	2-1
KE430F(Heavy)	P76	2-1
KE430F(Light)	P76	2-1
KE430F(Medium)	P76	2-1
KE441	P42	1-3
KE450	P60	3-1
KE492(10)	P57	3-1
KE492(10)[5A]	P57	3-1
KE496-1	P88	2-1
KE496-2	P88	2-1
KE496-3	P88	2-1
KE496-4	P88	2-1
KE496-5	P88	2-1
KE497	P65	1-2
KE535	P65	1-3
KE537[4A]	P55	1-3
KE537[4A]	P59	3-1
KE557	P67	1-1
KE585	P65	1-1
KE593	P61	1-1
KE594	P61	1-1
KE600(6)	P58	1-1
KE600(6)[4A]	P58	1-1
KE601	P58	1-3
KE601(10)	P58	1-2
KE601(10)[4A]	P58	1-2
KE601(10)[5A]	P58	1-2
KE610(6)	P58	1-4
KE610(6)[4A]	P58	1-4
KE668	P41	4-6
KE678	P59	1-3
KE688	P58	2-4
KE725(8)[5A]	P55	2-1
KE767	P65	1-4
KE817(7)	P57	3-4
KE841(4)[4A]	P59	3-2
KE868	P49	4-2
KE869	P49	4-1
KE872	P42	2-1
KE873(6)	P56	1-1
KE873(6)[4A]	P56	1-1
KE873(6)[5A]	P56	1-1
KE874(8)	P56	1-2
KE874(8)[4A]	P56	1-2
KE874(8)[5A]	P56	1-2
KE875(8)	P56	1-3

品号 PART NO.	页数 PAGE	行数 LINE
KE875(8)[4A]	P56	1-3
KE875(8)[5A]	P56	1-3
KE878	P39	4-1
KE915(6)	P56	3-1
KE915(6)[5A]	P56	3-1
KE916(6)	P60	1-3
KE916(6)[5A]	P60	1-3
KE918[4A]	P57	2-2
KE919(8)	P57	1-1
KE919(8)[5A]	P57	1-1
KE920(8)	P57	1-2
KE920(8)[5A]	P57	1-2
KE920(8)[TC]	P57	1-3
KE947	P61	1-1
KE996	P39	3-4
KE997	P39	3-5
KE998	P39	3-6
KE999	P39	3-7
KG131	P145	5-4
KG153	P147	5-1
KG155	P147	5-2
KG201	P219	5-4
KG229	P220	6-1
KG230	P220	7-1
KG231K-E	P148	5-1
KG231K-E	P197	3-5
KG242K-E	P148	5-2
KG242K-E	P197	4-1
KG244	P220	4-1
KG253K-E	P148	5-3
KG253K-E	P197	4-2
KG255K-E	P148	5-4
KG255K-E	P197	4-3
KG31D	P219	7-1
KG333	P147	5-3
KG35	P219	5-3
KG355	P147	5-4
KG37	P219	8-1
KG433K-E	P148	5-5
KG433K-E	P197	4-4
KG455K-E	P197	4-5
KG471	P219	5-1
KG472	P219	5-2
KG59	P219	6-1
KL1530-7-1	P42	3-1
KL1530-7-1	P42	3-2
KL202	P219	2-2
KL202	P220	2-1
KL202A	P219	2-2
KL202A	P220	2-1
KL204	P219	6-2
KL204	P220	5-1
KL25	P219	2-1
KL25A	P219	2-1
KL35	P219	2-1
KL35A	P219	2-1
KM04	P219	4-1
KM203	P220	3-1
KNIT-1	P63	3-3
KNIT-2	P63	3-4
KR23	P30	2-3
KR23A	P30	2-4
KR23C	P30	2-5

品号 PART NO.	页数 PAGE	行数 LINE
KR35	P30	1-3
KR35C	P30	1-4
KR55	P30	2-2
KS24	P32	1-8
KS56	P145	4-4
KS56	P145	4-5
KS56	P146	4-1
KS56	P146	4-2
KS56	P146	4-3
KS56	P146	4-4
KS56	P146	4-5
KS56	P193	2-2
KS56	P193	2-4
KS56	P193	3-2
KS56	P193	3-4
L		
L9012	P153	5-2
L9012	P154	5-1
L9104	P153	5-1
L9112	P153	5-2
L9112	P153	5-3
L9112	P154	5-1
L9117	P155	5-1
L9119P-E	P154	5-2
L9121	P155	5-2
L9123	P155	5-3
L9131	P154	5-3
LECTRA 715	P44	1-1
LK-1850	P79	2-1
LK-1900A	P80	2-1
LK1900	P80	1-1
LK1910/LK1920	P81	2-1
LL81600	P212	6-3
LLC00560	P212	6-1
LLF00560	P212	6-2
LP21	P219	3-1
LP225	P219	1-4
LP225	P219	1-5
LP226	P219	1-5
LP226	P220	1-1
LP227	P219	1-5
LP228	P219	1-5
LP229	P219	1-5
LP231	P219	1-5
LP231	P219	3-1
LP24	P219	1-1
LP26	P219	1-1
LP26	P219	1-2
LP26	P219	1-3
LP26/ZJ	P219	1-1
LP26A	P219	1-1
LP26A	P219	1-2
LP26A	P219	1-3
LP28	P219	1-2
LP29	P219	3-1
LP36	P219	1-2
LP36A	P219	1-2
LP38	P219	1-2
LP38	P219	1-3
LP38A	P219	1-3
LP38D	P219	1-2
LR21	P31	1-1
LU02	P31	3-6

品号 PART NO.	页数 PAGE	行数 LINE
LU04	P31	3-8
LU05	P31	3-7
LU101	P31	4-3
LU103	P31	4-4
LU501	P31	4-5
LU503	P31	4-6
LU602	P31	4-1
LU605	P31	4-2
LX-045	P174	4-5
LYDZ-A-18	P50	2-3
M		
M0700(6)[4A]	P55	3-1
M0702[4A]	P55	2-4
M0703(8)[4A]	P55	3-2
M4232	P197	3-1
M4240	P149	5-2
M4240	P149	5-4
M4240	P152	5-1
M4248	P152	5-1
M4348	P197	3-3
M4356	P149	5-1
M4356	P149	5-3
M4356	P149	5-5
M4356	P150	5-1
M4356	P152	5-2
M4356	P152	5-3
M4364	P149	5-3
M4364	P152	5-2
M4460	P152	5-4
M5232	P197	3-2
M5240	P150	5-2
M5240	P151	5-2
M5248	P150	5-2
M5248	P151	5-2
M5348	P197	3-4
M5356	P150	5-3
M5356	P150	5-4
M5356	P151	5-1
M5356	P151	5-3
M5364	P150	5-3
M5364	P151	5-1
M5364	P151	5-3
M9012	P153	4-2
M9012	P154	4-1
M90605010	P87	1-1
M90906003	P87	1-1
M9104	P153	4-1
M9108	P153	4-3
M9112	P153	4-2
M9112	P154	4-1
M9112	P154	4-1
M91129015	P87	1-1
M9113	P154	4-2
M9117	P155	4-1
M9121	P155	4-2
M9123	P155	4-3
M9313	P154	4-3
M96004052	P87	1-1
MA03A1-101	P87	1-1
MA10B2476	P87	1-1
MAS-11012	P11	1-5
MAS-11013	P11	1-6
MAS-11016	P11	2-1
MAS-11017	P11	2-2

品号 PART NO.	页数 PAGE	行数 LINE
MAT-00504000-A	P49	2-5
MAT-00505000	P49	2-4
MAT-02203000	P10	4



索引表
PARTS LIST

INDUSTRIAL SEWING MACHINE SPARE PARTS

索引表
PARTS LIST

INDUSTRIAL SEWING MACHINE SPARE PARTS



品号 PART NO.	页数 PAGE	行数 LINE	品号 PART NO.	页数 PAGE	行数 LINE	品号 PART NO.	页数 PAGE	行数 LINE	品号 PART NO.	页数 PAGE	行数 LINE	品号 PART NO.	页数 PAGE	行数 LINE	品号 PART NO.	页数 PAGE	行数 LINE	品号 PART NO.	页数 PAGE	行数 LINE			
P1813-A	P193	4-3	P955	P147	4-3	R4200-J0E-D00	P113	1-5	R4612-L0D-E0I	P113	1-4	S00903-001	P79	1-1	S09367-101	P99	3-2	S15736-001	P96	5-1	S19199-001	P102	3-5
P1814	P149	4-4	P964-A	P193	2-7	R4200-J6E-D00	P114	1-5	R4612-L0F-G00	P113	1-2	S00906-001	P191	1-6	S09367-101	P99	3-5	S15736-001	P97	5-2	S19200-001	P102	3-5
P1814	P151	4-3	P975-3	P193	3-2	R4200-L0E-D00	P112	1-1	R4612-L0F-L00	P113	1-3	S00907-001	P191	1-5	S10203-201	P168	1-2	S15736-001	P98	5-2	S19201-001	P102	3-5
P1815	P151	4-3	P975-4	P193	3-4	R4200-L0E-E00	P111	1-3	R4612-L0H-G00	P113	1-3	S01248-001	P200	2-1	S10205-001	P4	2-5	S15736-001	P99	5-4	S19201-001	P103	3-3
P201-4A	P148	4-1	P975/F380	P193	3-1	R4200-L0E-E02	P169	2-1	R4612-L0H-L00	P113	1-3	S01248-001	P200	2-2	S10208005	P75	2-1	S15747-001	P100	4-2	S19202-001	P103	3-4
P201-4A	P193	3-5	P975/F381	P193	3-3	R4200-L2E-E00	P111	1-5	R4E	P54	1-1	S01248-001	P200	2-3	S10209101	P75	2-1	S15747-001	P96	4-2	S19202-001	P104	3-1
P201-A	P148	4-1	PE211	P122	3-2	R4205-E0D-E00	P115	1-6	R5 1/4E	P54	1-2	S01249-001	P201	2-2	S10210-001	P4	2-6	S15747-001	P97	4-2	S19204-001	P103	3-1
P201-A	P193	3-6	PE212	P122	3-2	R4205-H0D-E00	P110	1-3	R5KM	P54	3-3	S01584-001	P3	4-6	S10210-201	P4	2-4	S15747-001	P98	4-5	S19204-001	P103	3-4
P203-A	P193	3-7	PE213	P122	3-2	R4205-H0D-EA0	P110	1-4	R5KM[4A]	P54	3-3	S01694001	P78	1-1	S10210201	P75	2-1	S15748-001	P100	5-2	S19204-001	P103	3-5
P2116-A	P149	4-1	PE214	P122	3-1	R4205-J0E-E00	P169	3-3	R5KM[5A]	P54	3-3	S01711	P166	1-1	S10211-001	P167	2-5	S15748-001	P96	5-2	S19204-001	P104	3-1
P2116-A	P151	4-4	PE215	P122	3-1	R4205-J6E-E00	P115	1-1	R6KM	P54	3-4	S01711-001	P166	3-2	S10212-101	P167	2-5	S15748-001	P97	5-2	S19206-001	P103	3-2
P2116-A	P152	4-3	PE224	P121	3-3	R4253-F0H-GOP	P170	2-1	R6KM[4A]	P54	3-4	S01713-001	P166	3-2	S10213-101	P167	2-5	S15748-001	P98	5-2	S19210-001	P103	3-2
P2117-A	P151	4-4	PE226	P108	3-2	R4300-E0F-E00	P169	2-2	R6KM[5A]	P54	3-4	S02374-001	P4	3-1	S10213101	P75	2-1	S15753-001	P100	4-3	S19211-001	P103	3-2
P2117-A	P152	4-3	PE227	P108	3-2	R4300-H0D-E00	P110	1-1	R9012	P153	6-2	S02375-001	P4	2-7	S10570-001	P166	1-3	S15753-001	P96	4-2	S19212-001	P103	3-1
P212-5A	P193	2-6	PE228	P108	3-4	R4300-J0E-E00	P169	3-1	R9012	P154	6-1	S02637-001	P3	2-5	S10572-001	P166	1-4	S15753-001	P97	4-3	S19212-001	P103	3-5
P212A-A	P193	2-5	PE238	P141	4-2	R4300-L0F-E00	P111	1-4	R9104	P153	6-1	S02637-001	P52	2-5	S10573-001	P166	1-5	S15753-001	P99	4-1	S19213-001	P103	3-1
P217-4	P193	4-1	PE244	P121	2-3	R4305-E0D-D00	P169	2-3	R9112	P153	6-2	S02637-001/M	P3	2-5	S10574-001	P166	1-6	S15753-001	P99	4-5	S19213-001	P103	3-3
P220-A2	P193	4-2	PE245.L	P195	2-2	R4305-EDD-E0A	P169	2-3	R9112	P154	6-1	S02643-001	P3	2-6	S10605-001	P2	4-2	S15754-001	P100	5-3	S19213-001	P103	3-5
P2314-A	P193	4-4	PE245.R	P195	3-2	R4305-H0D-E00	P110	1-2	R9113	P154	6-2	S02643-001	P52	2-6	S10696-001	P79	1-1	S15754-001	P96	5-2	S19217-001	P103	3-3
P2315-A	P194	1-1	PE396.L	P195	2-3	R4305-H0E-E00	P109	1-2	R9117	P155	6-1	S02645-001	P3	2-3	S11508-101	P101	1-2	S15754-001	P97	5-3	S19219-001	P104	3-1
P233-A	P147	4-4	PE396.R	P195	3-3	R4305-H0F-E00	P169	3-2	R9121	P155	6-2	S02645-001(H)	P3	2-3	S13-6	P34	4-3	S15754-001	P99	5-1	S19223-101	P104	3-3
P233J-A	P148	4-4	PF03030825	P51	4-3	R4305-J0D-E00	P169	3-4	R9123	P155	6-3	S02645-001/M	P3	2-3	S13-8	P34	4-4	S15754-001	P99	5-5	S19223-101	P104	3-4
P2408	P152	4-5	PF03030828	P51	4-2	R4305-J0D-E00(窄舌)	P169	3-4	R9313	P154	6-3	S02646-001	P3	2-4	S13588-001	P96	2-1	S15759-001	P96	4-2	S19223-101	P104	3-5
P2416-A	P149	4-5	PF605C32	P130	4-1	R4305-J0E-E00	P113	1-6	REECE10018MM	P47	4-1	S02646-001(H)	P3	2-4	S13588-001	P98	2-2	S15760-001	P96	5-2	S19228-101	P104	3-4
P2416-A	P150	4-4	PF634D03	P130	4-2	R4305-J0E-E00	P169	3-4	REECE10019MM	P47	4-1	S03627-001	P6	1-1	S13588-001	P99	2-4	S15765-001	P100	4-4	S19229-001	P104	3-4
P2436-A	P194	1-2	PFM010803	P51	4-1	R4305-J0E-E00(窄舌)	P169	3-4	REECE10020MM	P47	4-1	S03629-001	P6	1-2	S15711-001	P100	4-1	S15765-001	P96	4-3	S19236-001	P102	2-6
P2438Q-A	P194	1-3	PFM90143	P51	4-7	R4305-J6D-E00	P169	3-5	REECE10024MM	P47	4-1	S05946-101	P101	1-1	S15711-001	P94	4-5	S15765-001	P97	4-4	S19237-101	P103	2-4
P2446-A	P151	4-2	PFM90143A	P51	4-7	R4305-J6E-E00	P114	1-6	REECE10029MM	P47	4-1	S06310-001	P101	5-1	S15711-001	P95	4-2	S15765-001	P99	4-2	S19240-001	P103	2-1
P2447-A	P151	4-2	PFM90804	P51	4-4	R4305-L0E-E00	P112	1-2	REECE10030MM	P47	4-1	S07525-000	P2	4-3	S15711-001	P97	4-1	S15765-001	P99	4-5	S19240-001	P103	2-3
P2457-A	P194	1-4	PFMJ0824	P51	4-5	R4305-L0E-E0A	P112	1-3	REECE10035MM	P47	4-1	S07526-001	P2	4-5	S15711-001	P98	4-4	S15766-001	P100	5-4	S19240-001	P103	2-5
P253E-3	P145	4-4	PFMJ0826	P51	4-6	R4308-J6F-E0B	P169	4-2	REECE38	P33	4-3	S07526-201	P2	4-6	S15711-001	P99	4-3	S15766-001	P96	5-3	S19244-101	P104	2-1
P253E-4	P146	4-3	PIDA0	P39	3-1	R4354-F0H-G0B	P170	2-2	REECE38-1	P33	4-4	S07526-301	P3	1-1	S15712-001	P100	5-1	S15766-001	P97	5-4	S19247-001	P104	2-4
P253E/F371	P145	4-4	PIDA0[HSS]	P39	3-1	R4508-E0D-C00	P169	2-4	RF702/AF702	P41	2-7	S07526-301[TI]	P3	1-2	S15712-001	P94	5-1	S15766-001	P99	5-2	S19260-001	P102	4-6
P253E/F374	P146	4-3	PLK1006	P87	1-1	R4508-H0D-D00	P110	1-5	RF703/AF703	P41	2-8	S07527-001	P2	4-4	S15712-001	P95	5-2	S15766-001	P99	5-5	S19260-001	P103	4-1
P2544-A	P194	1-6	PLK1006	P87	1-1	R4508-H0F-D00	P110	1-5	RH-9820-1	P78	1-1	S07878-001	P92	2-2	S15712-001	P97	5-1	S15771-001	P100	4-4	S19271-001	P103	4-3
P2545-A	P194	2-1	PM20C	P88	2-1	R4508-J0D-D00	P169	4-5	RH-9820-2	P78	2-1	S07878-001	P95	2-1	S15712-001	P98	5-1	S15771-001	P96	4-3	S19287-201	P103	4-5
P254G-4	P146	4-5				R4508-J0E-D00	P114	1-1	RS-100	P56	2-1	S07879-001	P92	2-2	S15712-001	P99	5-3	S15771-001	P97	4-4	S19293-001	P103	4-6
P254G/F504G	P146	4-5	Q21-004	P52	1-1	R4508-J0E-D00(窄舌)	P169	4-4	RS-100(8)	P56	2-2	S07879-001	P95	2-1	S15717-001	P95	4-3	S15771-001	P99	4-2	S19297-001	P104	4-1
P255-A	P147	4-5	Q21-033	P52	1-2	R4508-J0F-D00	P169	4-5	RS-100(8)[4A]	P56	2-2	S07880-001	P92	2-1	S15718-001	P95	5-3	S15771-001	P99	4-5	S19313-201	P104	4-2
P3816R-A	P194	2-3	Q21-036	P52	1-3	R4508-J6E-D00	P170	1-4	RS-100(8)[5A]	P56	2-2	S07880-001	P94	2-5	S15723-001	P100	4-2	S15772-001	P100	5-4	S19317-101	P104	4-3
P3817R-A	P194	2-3				R4508-J6E-D0C	P170	1-4	RS-100[4A]	P56	2-1	S08302-001	P6	3-2	S15723-001	P95	4-1	S15772-001	P96	5-3	S19318-101	P104	4-3
P502	P147	4-2	Q			R4508-L0E-G00	P112	1-4	RS-100[5A]	P56	2-1	S08322-001	P6	3-1	S15723-001	P95	4-4	S15772-001	P97	5-4	S19334-001	P104	4-4
P502J-A	P148	4-3	R1 1/4	P59	2-1	R4608-H0D-F00	P169	4-3	RS-110(8)	P56	2-3	S08709-001	P196	1-4	S15723-001	P96	4-1	S15772-001	P99	5-2	S19824-001	P5	3-1
P504	P147	4-1	R1 1/4(TFL)	P59	2-2	R4608-H0F-G00	P169	4-3	RS-110(8)[4A]	P56	2-3	S08711-001	P196	1-5	S15723-001	P97	4-2	S15772-001	P99	5-5	S19955-001	P103	3-4
P504J-A	P148	4-2	R1512	P55	3-3	R4608-J0E-D00	P114	1-2	RS-110(8)[5A]	P56	2-3	S08713-001	P196	1-6	S15723-001	P98	4-5	S16248-001	P6	3-3	S20118-001	P4	4-2
P5232K-A	P194	2-2	R1512[4A]	P55	3-3	R4608-J0F-D00	P170	1-3	RS-50	P54	2-4	S08723-001	P166	4-3	S15723-001	P99	4-4	S16248-001.SH	P6	3-3	S20232-001	P104	1-3
P570A/P569	P192	4-4	R1513(6)	P55	3-4	R4608-J0F-D0A	P170	1-3	RS-50(6)	P54	3-1	S08724-001	P166	4-3	S15724-001	P100	5-2	S16413-001	P2	4-1	S20233-001	P104	1-3
P7-11[4.0]	P186	3-3	R1513(6)[4A]	P55	3-4	R4608-J0F-D0A	P115	1-2	RS-50(7)	P54	3-2	S08724-001-G	P166	4-4	S15724-001	P95	5-1	S175-A	P60	3-5	S20234-001	P104	1-2
P7-11[5.6]	P186	3-4	R151LIGIA	P44	2-4	R4608-L0E-G00	P112	1-5	RS-50(7)[4A]	P54	3-2	S08731-001	P166	4-5	S15724-001	P95	5-4	S18061-001	P200	6-4	S20235-001	P104	1-2
P8-50	P34	2-5	R16092(6)	P55	2-2	R4608-L0E-G0A	P113	1-1	RU10	P31	4-7	S08732-001	P166	4-5	S15724-001	P96	5-1	S18426-001	P74	2-1	S20236-001	P104	1-2
P8003-A	P194	2-4	R16092(6)[5A]	P55	2-2	R4612-H0D-E0I	P111	1-2	RJ14	P31	4-8	S08913-001	P201	2-5	S15724-001	P97	5-2	S19145-001	P102	1-6	S20239-101	P104	3-3
P8104-A	P194	2-5	R2KM																				



索引表
PARTS LIST

INDUSTRIAL SEWING MACHINE SPARE PARTS

索引表
PARTS LIST

INDUSTRIAL SEWING MACHINE SPARE PARTS



品号 PART NO.	页数 PAGE	行数 LINE	品号 PART NO.	页数 PAGE	行数 LINE	品号 PART NO.	页数 PAGE	行数 LINE	品号 PART NO.	页数 PAGE	行数 LINE	品号 PART NO.	页数 PAGE	行数 LINE	品号 PART NO.	页数 PAGE	行数 LINE	品号 PART NO.	页数 PAGE	行数 LINE	品号 PART NO.	页数 PAGE	行数 LINE
S20415-001	P201	6-1	S2703-377-0A0	P84	1-1	S37671-001	P5	1-3	S50303-101	P79	1-1	SA3652-201	P76	2-1	SA8458-001	P74	1-1	SS-1060210-TP	P82	1-1	TE1962.A	P88	2-1
S20415-001	P201	6-3	S28348-001	P2	3-4	S37672-101	P5	1-5	S50404-101	P5	3-2	SA3652-201	P167	3-3	SA8459-001	P4	4-5	SS-1060210-TP	P82	2-1	TE2096	P122	6-2
S20418-001	P201	8-1	S28352-001	P2	1-2	S37675-001	P5	1-4	S50404-301	P5	3-2	SA3653-201	P75	1-1	SA8459-001	P74	1-1	SS-1060210-TP	P83	1-1	TE238	P177	3-2
S20421-001	P201	3-1	S28650-201	P2	3-6	S37676-101	P5	1-6	S50404-401	P5	3-2	SA3653-201	P76	2-1	SA8704-101	P89	1-1	SS-1060210-TP	P86	1-1	TE2905	P122	4-2
S20422-001	P200	1-3	S28654-001	P2	3-7	S37703-001	P45	2-1	S50404-401	P79	1-1	SA3653-201	P167	3-3	SB0598-001	P3	3-2	SS-1060210-TP	P86	2-1	TE2907	P122	5-2
S20422-001	P201	1-1	S29437-001	P3	1-3	S37704-001	P45	2-1	S50664-001	P167	1-4	SA3654-201	P76	1-1	SB0712-001	P167	4-5	SS-1090510-SP	P85	2-1	TE2989	P121	4-3
S20423-001	P201	3-1	S29797-201	P3	1-4	S37705-001	P45	2-1	S50664-001(1.4)	P79	1-1	SA3654-201	P77	1-1	SB0713-001	P76	2-1	SS-2090510-SP	P84	2-1	TE2990	P121	6-1
S20424-001	P200	1-3	S29948-001	P103	4-2	S37706-001	P45	2-1	S51248-001	P167	1-3	SA3654-201	P167	4-4	SB0713-001	P77	1-1	SS-4080310-SP	P84	2-1	TE2991	P121	5-1
S20424-001	P200	1-4	S29997-001	P167	3-2	S37707-001	P45	2-1	S51248-101(1.2)	P79	1-1	SA3655-001	P75	1-1	SB0715-001	P167	3-6	SS-5090320-SP	P84	2-1	TE3009	P88	2-1
S20424-001	P201	1-1	S30525-001	P104	4-5	S37708-001	P45	2-1	S51449-001	P167	3-1	SA3655-001	P76	1-1	SB0949-001	P76	2-1	SS-6090440-SP	P84	2-1	TE3058	P108	4-2
S20424-001	P201	1-3	S32122-001	P96	4-3	S37709-001	P45	2-1	S550252-001	P79	1-1	SA3656-001	P4	1-4	SB0949-001	P167	4-2	SS-6110430-TP	P79	2-1	TE3059	P108	4-2
S20426-001	P200	1-3	S32123-001	P96	5-3	S37723-001	P5	2-5	S55215-001	P89	1-1	SA3658-001	P4	1-5	SB0951-001	P167	3-6	SS-6110430-TP	P80	1-1	TE3060	P108	4-4
S20428-001	P200	1-3	S34884-000	P78	1-1	S38015001	P75	2-1	S55215-001	P89	1-1	SA3658-001.A(H)	P4	1-5	SB0952-001	P167	4-1	SS-6110430-TP	P80	2-1	TE318	P178	1-10
S20428-001	P201	1-1	S34886-001	P78	2-1	S38016-001	P75	2-1	S55217-201	P89	1-1	SA3698-001	P76	2-1	SB0953-001	P167	4-5	SS-6110430-TP	P81	1-1	TE503	P166	1-2
S20429-001	P201	3-1	S34887-001	P78	2-1	S38306-501	P201	5-1	S55863-001	P4	4-4	SA4320-001	P76	1-1	SB1173-001	P89	1-1	SS-6110430-TP	P81	2-1	TE531	P187	2-4
S20430-001	P200	1-4	S34888-101	P78	2-1	S38307-001	P201	7-1	S55863-001	P74	1-1	SA4329-001	P75	1-1	SB1189-001	P4	1-6	SS-6110430-TP	P82	1-1	TK17(1 Convexity)	P58	3-1
S20430-001	P201	1-3	S34890-001	P78	2-1	S38595-001	P104	3-5	S55864-001	P4	4-5	SA4330-001	P75	1-1	SB1189-001	P76	2-1	SS-6110430-TP	P82	2-1	TK17(1 Convexity)[4A]	P58	3-1
S20432-001	P200	1-4	S34891-101	P78	2-1	S38596-001	P104	3-5	S55865-001	P74	1-1	SA4330-001	P76	1-1	SB1189-001	P77	1-1	SS-6110430-TP	P83	1-1	TK17(2 Convexity)	P58	3-2
S20432-001	P201	1-3	S34892-001	P78	2-1	S38597-001	P104	2-5	S56368-001	P5	4-7	SA4518-001	P75	1-1	SB1189-001/M	P4	1-6	SS-7060310-SP	P85	2-1	TK17(2 Convexity)[4A]	P58	3-2
S20434-001	P200	1-4	S34893-001	P78	2-1	S39653-001	P200	5-3	S56370-001	P5	4-6	SA4518-001	P76	1-1	SB1191-001	P4	1-7	SS-7080310-SP	P83	2-1	TK18	P58	3-3
S20434-001	P201	1-3	S34894-001	P78	2-1	S40335-101	P101	3-1	S56917-001	P5	4-5	SA4518-001	P76	2-1	SB1191-001	P76	2-1	SS-7080310-SP	P84	1-1	TK18[4A]	P58	3-3
S20436-001	P200	1-4	S34895-001	P5	2-4	S40369-001	P101	2-1	S57668-001.A	P4	3-3	SA4518-001	P77	1-1	SB1191-001	P77	1-1	SS-7090410-SP	P79	2-1	TK18[5A]	P58	3-3
S20436-001	P201	1-3	S34895-001	P78	2-1	S40370-001	P101	2-2	S57668-001.CT	P4	3-4	SA4518-001	P77	2-1	SB1191-001/M	P4	1-7	SS-7090410-SP	P80	1-1	TM26	P32	1-6
S20438-001	P200	1-3	S34896-001	P78	2-1	S40375-001	P202	1-1	S57670-001	P4	3-5	SA4519-001	P75	1-1	SB3214-001	P4	3-2	SS-7090410-SP	P80	2-1	TM27	P32	1-5
S20438-001	P200	1-4	S34899-001	P5	2-3	S40376-001	P202	1-2	S57670-001.CT	P4	3-6	SA4519-001	P76	2-1	SB4595-001	P168	1-1	SS-7090410-SP	P81	1-1	TP2120014	P175	2-1
S20438-001	P201	1-1	S34899-001	P78	1-1	S40377-001	P202	1-3	S58941-201	P74	1-1	SA4519-001	P77	1-1	SB4941-001	P3	3-4	SS-7090410-SP	P81	2-1	TP603032	P175	2-5
S20438-001	P201	1-3	S34900-001	P78	1-1	S40389-001	P202	1-6	S58943-001	P4	4-4	SA4519-001	P77	2-1	SB4942-101	P3	3-3	SS-7090410-SP	P82	1-1	TP603053A	P175	3-2
S20440-001	P200	1-4	S35029-001	P5	2-6	S40390-005	P202	1-6	S58943-001	P74	1-1	SA4519-001	P77	2-1	SB4945-001	P76	2-1	SS-7090410-SP	P82	2-1	TP604A33	P175	3-4
S20440-001	P201	1-3	S35092-001	P45	1-3	S40391-001	P202	1-4	S6397-001	P76	2-1	SA5157-101	P77	2-1	SB4945-001	P77	1-1	SS-7090410-SP	P83	1-1	TP604A42	P175	3-5
S20442-001	P200	1-4	S35092-001	P45	3-1	S40392-001	P202	1-5	S70817-001	P64	1-8	SA5221-001	P77	2-1	SB4954-101	P3	3-5	SS-7090410-SP	P86	1-1	TP604A43	P175	4-1
S20442-001	P201	1-3	S35093-001	P45	1-3	S40393-001	P202	2-1	SA1360-101	P3	3-1	SA5221-001	P167	2-4	SB7053-001	P4	2-1	SS-7090410-SP	P86	2-1	TP604A53	P175	4-1
S20454-001	P200	1-4	S35093-001	P45	3-1	S40394-001	P202	2-2	SA1881-001	P89	1-1	SA5222-101	P167	2-4	SB7055-001	P4	2-2	SS-7090610-SP	P85	2-1	TP604B33	P175	4-2
S20494-001	P102	4-6	S35410-001	P202	3-6	S41345-001	P45	2-2	SA1882-001	P89	1-1	SA6133-001	P167	4-3	SC-2	P64	1-10	SS-7110570-SP	P84	2-1	TP604B53	P175	4-3
S20494-001	P103	4-1	S35411-001	P202	3-5	S41346-001	P45	2-3	SA3001-001	P79	1-1	SA6273-101	P77	2-1	SD-0250101-SP	P85	1-1	SS-7110740-TP	P79	2-1	TP605C32	P130	1-1
S20494-001	P103	4-2	S35412-001	P202	3-7	S41347-001	P45	2-4	SA3239-301	P89	1-1	SA6397-001	P75	1-1	SD-0500091-TP	P79	2-1	SS-7110740-TP	P80	1-1	TP605C52	P130	1-1
S20494-001	P103	4-3	S35413-001	P202	3-4	S41348-001	P45	2-5	SA3284-201	P89	1-1	SA6397-001	P76	1-1	SD-0500091-TP	P80	1-1	SS-7110740-TP	P80	2-1	TP605C53	P176	2-3
S20494-001	P103	4-4	S35436-001	P45	1-1	S42053-001	P45	2-1	SA3284-201	P89	1-1	SA6397-001	P77	1-1	SD-0500091-TP	P80	2-1	SS-7110740-TP	P81	1-1	TP605D53	P176	2-3
S20494-001	P103	4-5	S35436-001/M	P45	1-1	S4305-JOB-E00	P169	4-1	SA3330-001	P4	1-1	SA6397-001	P77	2-1	SD-0500091-TP	P81	1-1	SS-7110740-TP	P81	2-1	TP606CA3	P176	3-3
S20494-001	P103	4-6	S35437-001	P45	1-2	S44132-001	P4	3-7	SA3330-001	P77	2-1	SA6398-001	P75	1-1	SD-0500091-TP	P81	2-1	SS-7110740-TP	P82	1-1	TP606DA3	P176	3-4
S20494-001	P104	4-1	S35437-001/M	P45	1-2	S44134-001	P4	4-1	SA3333-001	P75	1-1	SA6398-001	P76	1-1	SD-0500166-TP	P85	1-1	SS-7110740-TP	P82	2-1	TP624A32	P175	3-3
S20579-101	P2	2-4	S35479-001	P45	2-1	S4519-001	P76	1-1	SA3333-001	P76	1-1	SA6398-001	P77	1-1	SD-0500167-TP	P85	1-1	SS-7110740-TP	P83	1-1	TP624A43	P175	3-1
S20582-001	P2	1-3	S36562-001	P100	3-2	S45900-101	P3	4-4	SA3334-001	P75	1-1	SA6398-001	P77	2-1	SD-0600095-TH	P83	2-1	SS-7110740-TP	P87	2-1	TP634D03	P130	1-2
S20583-001	P2	1-4	S36564-001	P100	3-4	S48006-001	P4	4-3	SA3334-001	P76	1-1	SA6429-001	P75	1-1	SD-0600095-TH	P84	1-1	ST17	P28	1-2	TP645C53	P176	1-5
S20626-001	P200	2-4	S36566-001	P100	3-4	S48236-401	P74	1-1	SA3334-001	P76	2-1	SA6429-001	P76	1-1	SE2-68121[HSS]	P36	2-6	ST18	P28	1-3	TP645D53	P176	2-4
S20626-001	P201	2-1	S36566-001	P97	3-3	S48238-101	P74	1-1	SA3334-001	P77	1-1	SA6431-001	P75	1-1	SE2-68184[HSS]	P36	2-7				TP675C53	P176	2-1
S20627-001	P200	2-5	S36566-001	P191	1-1	S48239-001	P74	1-1	SA3334-001	P77	2-1	SA6431-001	P76	1-1	SE2-K26-17[HSS]	P34	3-6	TC-38-1	P63	3-1	TP6B3022	P175	2-2
S20627-001	P201	2-1	S36566-001.D0.8	P191	1-1	S48240-001	P74	1-1	SA3335-001	P4	1-2	SA6448-301	P89	1-1	SE2-K26-17[K][HSS]	P34	3-6	TC-38-2	P63	3-2	TP6B30221	P175	2-3
S20627-001	P201	2-3	S36625-001	P6	1-3	S48246-001	P74	1-1	SA3336-001	P75	1-1	SA6448-301	P89	1-1	SE2-K26-37[HSS]	P34	3-7	TE070	P177	3-4	TPC00561	P176	3-5
S20653-001	P201	4-1	S37194-001	P45	3-1	S48247001	P74	1-1	SA3336-101	P77	2-1	SA6596-001	P75	1-1	SE2-K26-37[K][HSS]	P34	3-7	TE070	P177	3-6	TPC00641	P176	3-5
S20896-101	P2	2-5	S37195-001	P45	1-3	S49029-001	P188	1-2	SA3336-101	P167	3-5	SA6596-001	P76	1-1	SF833(4)[4A]	P58	2						



索引表

PARTS LIST

INDUSTRIAL SEWING MACHINE SPARE PARTS

品号 PART NO.	页数 PAGE	行数 LINE	品号 PART NO.	页数 PAGE	行数 LINE	品号 PART NO.	页数 PAGE	行数 LINE	品号 PART NO.	页数 PAGE	行数 LINE
UT758	P31	1-6	Z-91-319899-95	P41	4-4						
UT759	P31	1-7	Z-91-319901-95	P41	4-5						
UTB01-14	P23	3-2	Z-91-383538-35	P52	2-7						
UTB0115	P23	2-6	ZS04	P41	2-4						
UTB0118	P23	2-7	ZS05	P41	2-3						
UTB0118.CT	P23	2-7	钢带刀	P71	1-1						
UTB0207	P23	3-1									
V											
VE30Q	P221	1-2									
VE30Q	P221	1-4									
VE30Q	P221	3-2									
VE30Q	P221	3-4									
VE49	P221	2-1									
VE49	P221	2-2									
VE49	P221	4-1									
VE49	P221	4-2									
VE51	P221	1-1									
VE51P	P221	1-3									
VE51Q	P221	3-1									
VE51T	P221	1-1									
VG56311	P186	4-3									
VH50	P34	1-2									
VSM47	P221	3-3									
VT04	P31	2-2									
VT05	P31	2-1									
VT1500EAUT-001	P88	2-1									
VT1500EAUT-004	P88	2-1									
VT1500EAUT-004	P88	2-1									
VT205	P31	3-4									
VT206	P31	3-5									
VUT104	P32	2-5									
VUT109P	P153	6-3									
VUT170	P32	2-6									
VUT188	P32	3-2									
VUT189	P32	3-1									
W											
WP-0431005-SP	P85	1-1									
WP-0431005-SP	P85	1-1									
WP-0431005-SP	P85	1-1									
WP-0450846-SP	P79	2-1									
WP-0450846-SP	P80	1-1									
WP-0450846-SP	P80	2-1									
WP-0450846-SP	P81	1-1									
WP-0450846-SP	P81	2-1									
WP-0450846-SP	P82	1-1									
WP-0450846-SP	P82	2-1									
WP-0450846-SP	P83	1-1									
WP-0450846-SP	P87	2-1									
WP-0451016-SP	P84	2-1									
WP-0451016-SP	P85	1-1									
WP-08	P8	4-3									
WP-09	P8	4-4									
WS-27002-KN	P85	2-1									
Z											
Z-91-102741-91	P50	1-4									
Z-91-102746-05	P50	1-3									
Z-91-110015-91	P50	1-2									
Z-91-110069-05	P50	1-1									
Z-91-136763-05	P195	3-1									
Z-91-136764-05	P195	2-1									
Z-91-188732-35	P52	2-7									
Z-91-192107-35	P52	2-7									
Z-91-192330-05	P52	2-4									