

**SANAYİ KONFEKSİYON MAKİNALARI BIÇAKLARI**  
KNIVES FOR INDUSTRIAL SEWING MACHINES

Brother.....	02-07	Singer.....	30
Durkopp.....	07-08	Reece.....	30-31
Dino.....	08	Toyota.....	31
Juki.....	08-16	Union Special....	31-32
Kansai Special....	16-18	Yamato.....	32-35
Kingtex.....	18-19	New Long.....	35
Mitsubishi.....	19-20	Others.....	35-38
Mauser.....	20	Brother.....	38-39
Merrow.....	20	Durkopp.....	39
Pfaff.....	20-21	Juki.....	40
Pegasus.....	21-23	Lsm.....	40
Rimoldi.....	23-26	Reece.....	40-41
Siruba.....	26-29	Singer.....	41
Sunstar.....	29		

**YUVARLAK KUMAŞ KESİM MOTORU BIÇAKLARI**  
ROUND KNIVES FOR END CUTTER MACHINES

**CAD KESİM BIÇAKLARI / CAD CUTTING KNIVES**

**İLİK BIÇAKLARI / BUTTON HOLE KNIVES**

**KUMAŞ KESİM MOTORU DİK BIÇAKLARI**  
STRAIGHT KNIVES FOR CUTTING MACHINES

**HIZAR BIÇAKLARI / BAND KNIVES**

Yuvarlak Kumaş Kesim Motoru Bıçakları.....	44-47
<small>Round Knives For End Cutter Machines</small>	
Yuvarlak Bıçak Alt Bıçakları.....	47
<small>Lower Knives For Round Knife</small>	
Kumaş Kesim Bıçakları.....	48
<small>Cloth Slitting Knives</small>	
Cad Kesim Bıçakları.....	49-54
<small>Cad Cutting Knives</small>	
İlik Bıçakları.....	55
<small>Button Hole Knives</small>	
Kesim Motoru Bıçak Kanalları.....	56
<small>Knife Slide For Cutting Machines</small>	
Kumaş Kesim Motoru Dik Bıçakları.....	57
<small>Straight Knives For Cutting Machines</small>	
Kesim Motoru Dalgalı Bıçakları.....	58
<small>Wave Knives For Cutting Machines</small>	
Kesim Motoru Yedek Parçaları.....	59
<small>Spare Parts For Cutting Machines</small>	
Hızar Bıçakları.....	60
<small>Band Knives</small>	

**SANAYİ KONFEKSİYON DİKİŞ MAKİNALARI PLAKALARI**  
NEEDLE PLATE ASSEMBLY FOR INDUSTRIAL SEWING MACHINES

Brother.....	62-64
Juki.....	65-70
Mitsubishi.....	71
Sunstar.....	71

**SANAYİ KONFEKSİYON DİKİŞ MAKİNALARI PLAKALARI**  
NEEDLE PLATE ASSEMBLY FOR INDUSTRIAL SEWING MACHINES

Brother.....	76-79	Mitsubishi.....	102
Juki.....	79-83	Singer.....	103

Kansai Special.....	84-89	Yamato.....	99-102
Kingtex.....	90-91	Sun Star.....	103
Pegasus.....	91-95	Union Special.....	103
Siruba.....	95-99	Pfaff.....	103-104

**SANAYİ KONFEKSİYON DİKİŞ MAKİNALARI DIŞLILERI**  
FEED DOG FOR INDUSTRIAL SEWING MACHINES

Brother.....	105-106	Pegasus.....	115-119
Juki.....	107-109	Siruba.....	119-122
Kansai Special...	109-114	Sunstar.....	122
Kingtex.....	114	Yamato.....	122-124

**SANAYİ KONFEKSİYON DİKİŞ MAKİNALARI AYAKLARI**  
PRESSER FOOT FOR INDUSTRIAL SEWING MACHINES

Brother.....	125-126	Pegasus.....	132-134
Juki.....	126-129	Siruba.....	134-136
Kansai Special...	130-131	Sunstar.....	136
Kingtex.....	132	Yamato.....	137-138

**SANAYİ DİKİŞ MAKİNALARI İÇNE BAĞLARI**  
NEEDLE CLAMP FOR INDUSTRIAL SEWING MACHINES

Brother.....	139	Pfaff.....	143
Juki.....	139-140	Siruba.....	143-145
Kansai Special...	140-141	Sunstar.....	145
Kingtex.....	142	Shing Ling.....	145
Pegasus.....	142-143	Yamato.....	145-146

**SANAYİ DİKİŞ MAKİNALARI İÇNE SİPERLERİ**  
NEEDLE GUARD FOR INDUSTRIAL SEWING MACHINES

Pegasus.....	147
Yamato.....	147
Juki.....	148

**SANAYİ DİKİŞ MAKİNALARI TAKIMLARI**  
GAUGE SET FOR INDUSTRIAL SEWING MACHINES

Brother.....	150-155	Pegasus.....	176-190
Juki.....	156-163	Siruba.....	190-199
Kansai Special...	163-174	Sunstar.....	200
Kingtex.....	175-176	Yamato.....	200-205

**BİLGİSAYARLI NAKİŞ MAKİNALARI BIÇAKLARI**  
KNIVES FOR COMPUTERIZED EMBROIDERY MACHINES

Tajima.....	208	Barudan.....	209
Pfaff.....	208	Others.....	209
Swf.....	208	Swf.....	210
Happy.....	209	Tajima.....	210-211
Zsk.....	209		



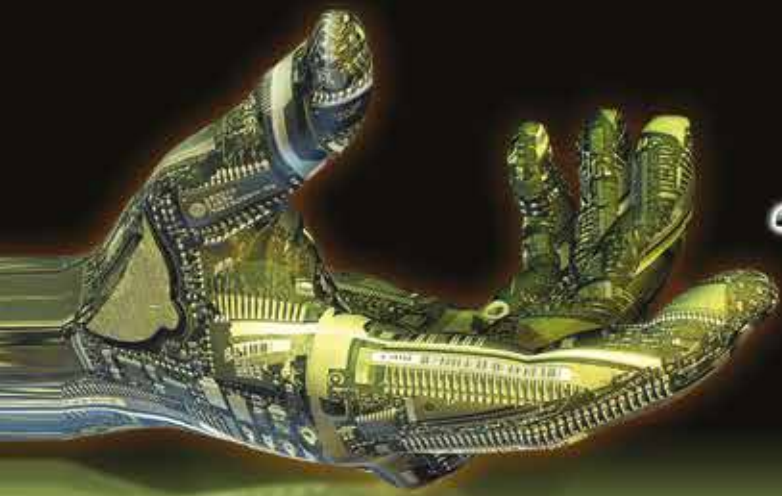

# **SHARD STEEL**

YEDEK PARÇALARI  
SPARE PARTS



SANAYİ KONFEKSİYON DİKİŞ MAKİNALARI  
**BIÇAKLARI**



**KNIVES**  
FOR INDUSTRIAL SEWING MACHINES



1-1  112436-001 B531	1-2  S28352-001 B272	1-3  S20582-001 N11	1-4  S20583-001 N11	1-5  S20899-001 N11	1-6  S09101-001 B271
2-1  144074-001 B531	2-2  144074-300 B531	2-3  148342-001 B511	2-4  148815-001 B531	2-5  S20579-101 N11	2-6  S20896-101 N11
3-1  S20897-101 N11	3-2  S20898-101 N11	3-3  140242-101 B500/B600	3-4  S09093-001 B271	3-5  S09094-001 B271	3-6  S28348-001
4-1  140888-001 EF2-B531	4-2  S28650-201	4-3  S28654-001	4-4  S16413-001 B787-4	4-5  S10605-001 SL-777B	4-6  S16248-001 BAS-610





















1-1  S07525-000 T8452/T8752	1-2  S07527-001 T8452/T8752	1-3  S07526-001 T-842/T-845/T-875	1-4  S07526-201 T8452A/T8752A	1-5  S07526-301 T8422B/T8452B/T8752B	1-6  S29437-001 TN-B842A/B
2-1  S29797-201 TN-B842A/B	2-2  154575-001 B716-400	2-3  154568-001 B716-400	2-4  S02645-001 S02645-001 (H) SL-737/S-6200 S-7200/SL211	2-5  S02645-001/M Super Material	2-6  S02646-001 S02646-001 (H) N11
3-1  S02637-001 SL737/S-6200 S-7200/SL211	3-2  S02637-001/M Super Material	3-3  S02643-001 SL737/S-6200 S-7200/SL211	3-4  SA1360-101 S-7200	3-5  SB0598-001 S-6200	3-6  159541-001 B791-403/S7220B-403
4-1  159540-001 B791-403	4-2  159915-001 S7220B-405	4-3  S45900-101 S7220B	4-4  154569-001 S7220B	4-5  159799-001 B728	4-6  154568-101 B728



FOR INDUSTRIAL SEWING MACHINES

1-1  S00706-201 LK3-B484	1-2  S00713-001 LK3-B484	1-3  S01584-001 LK3-B484	1-4  152901-001 LK3-B430	1-5  152906-101 LK3-B430	1-6  152905-001 LK3-B430
2-1  153219-001 LK3-B430	2-2  152897-201 LK3-B430	2-3  152981-001 LK3-B430	2-4  S10205-001 BAS-311A	2-5  S10210-001 BAS-311A	2-6  S49988-001 B430E
3-1  S10210-201 B430E	3-2  S02375-001 BAS-326/320/322	3-3  S02374-001 BAS-326/320/322	3-4  SB1189-001 BE-438F/KE-430F	3-5  SB1189-001/M Super Material	3-6  SB1191-001 BE-438F/KE-430F
4-1  SB1191-001/M Super Material	4-2  SB3214-001 BAS300G484	4-3  S57668-001 KE-484C	4-4  S57670-001 BAS300G484/KE-484C	4-5  SA3330-001 KE430D/BAS311G 326G/342G	4-6  SA3335-001 KE-430D

FOR INDUSTRIAL SEWING MACHINES

1-1  SA7944-001 BAS311G	1-2  SA3656-001 KE-430D	1-3  SA3658-001 KE-430D	1-4  S37723-001 RH9820/B981	1-5  S35029-001 RH9820/B981	1-6  S37671-101 B980-L3
2-1  S37675-101 B980-L3	2-2  S37672-101 B980-L4	2-3  S37676-101 B980-L4	2-4  SA6989-001 RH-9820-02	2-5  SA6988-001 RH-9820-02	2-6  S34899-001 RH-9820-01
3-1  S34895-001 RH-9820-01	3-2  S34900-001 RH-9820-01	3-3  141509-101 LH4-B814	3-4  S19824-001 LH4-B815/B816	3-5  S50404-101 HE-800A	3-6  S50404-301 HE-800A
4-1  S50259-101 HE-800A	4-2  141541-001 LH4-814	4-3  141541-101 LH4-B814	4-4  141543-001 LH4-B814	4-5  142419-001 LH4-B814	4-6  142416-001 LH4-B814



1-1  159274-001 LH4-B815	1-2  159276-001 LH4-B815	1-3  S56917-001 HM-818A	1-4  S56370-001 HM-818A	1-5  S56368-001 HM-818A	1-6  S55863-001 ZE-856A/Z-8560A
2-1  S58943-001 ZE-856A(H) Z-8560A(H)	2-2  S55864-001 ZE-856A ZE-856A(H)	2-3  SA8459-001 Z-8560A Z-8560A(H)	2-4  SA1360-001 S-7200/S-7200B T8452/T-8752	2-5  SA3299-001 KE-430D/KE-430F BAS-311G	2-6  S21230-001 CH-1
3-1  S21233-001 CH-1	3-2  S21253-001 CV-1	3-3  S21252-001 CV-1	3-4  S03627-001 BM-917B	3-5  S03629-001 BM-917B	3-6  S03567-001 BM-917B
4-1  S36624-001 BM-917B	4-2  S36625-001 BM-917B	4-3  105306-101 B925	4-4  030-0461-00 030-0461-00(Ti) BASS3200	4-5  030-0095-00 BASS3200	4-6  030-0096-00 BASS3200

1-1  030-0097-00 BASS3200	1-2  030-0098-00 BASS3200	1-3  746-60689 746	1-4  746-60690 746	1-5  746-60691 746	
2-1  746-60692 746	2-2  746	2-3  745339120 745-34	2-4  745339130 745-34	2-5  246-2553 745	2-6  246-2553(Ti) 745
3-1  745339100 745-34	3-2  745339110 745-34	3-3  227682 697	3-4  227683 697	3-5  227683(Ti) 697	3-6  2652197 697
4-1  0271001483 271	4-2  0271001497 271	4-3  0281 350300 281	4-4  0281 350310 281	4-5  51009080	4-6  5100912



FOR  
INDUSTRIAL SEWING MACHINES

1-1  558 9011 559	1-2  570-974 570	1-3  625780 557	1-4  625790 557	1-5  396 351690 550-16	1-6  568 350050 550-16
2-1  58110700000 8971	2-2  58111000000 8971	2-3  268350010 68 268 368	2-4  268350030 68 268 368	2-5  DINO UT08	
3-1  UT07 CTUT07	3-2  WP-08	3-3  WP-09	3-4  DST-06	3-5  DST-05	JUKI
4-1  115-66502 MO-1516	4-2  118-46003 MO-2414	4-3  118-47605 MO-2500	4-4  118-8610 MO-2000	4-5  B4118-804-000 MO-1014	4-6  B4118-804-00C MO-816

FOR  
INDUSTRIAL SEWING MACHINES

1-1  122203 MOG-3904	1-2  34749EL MFC7605U-H21	1-3  408-9102-01-A BL3-408	1-4  B4122-352-00A MO-352	1-5  12447504 MO-3300	1-6  13150701 MO-6700
2-1  400-38091 MF-7700	2-2  400-42378 MF-7800	2-3  134-60803 MF-7800	2-4  400-9101-01-B BL3-408	2-5  B4108-352-00B(L) MO-352	2-6  B4108-352-00B MO-352
3-1  118-47506 MO-2316	3-2  B4108-352-00D MO-352	3-3  118-2000 MO-2000	3-4  118-47407 MO-2314	3-5  118-45609 MO-2414	3-6  118-45708 MO-2416
4-1  124-45508 MO-3300	4-2  A4142655000 MO-655	4-3  120-04909 MO-2516	4-4  13150602 MO-6700	4-5  13150503 MO-6700	4-6  115-65900 MO-1516



FOR INDUSTRIAL SEWING MACHINES

1-1  118-45807 MO-2414	1-2  118-45906 MO-2416	1-3  B4111-804-00A MO-814	1-4  B4111-804-00C MO-816	1-5  B4111-804-00E MO-1514	1-6  400-38754 MF-7700
2-1  400-39364 MF-7800	2-2  134-61801 MF-7800	2-3  B1530-352-000 MO-352	2-4  B1528-804-000A MO-2414	2-5  13116702 MO-6700	2-6  115-21903 MO-1516
3-1  124-19602 MO-3300	3-2  B1130-026-000 MS-261	3-3  B1131-026-000 MS-261	3-4  12922704 MS-1190/MS-1260	3-5  MAT-02203000 T022	3-6  MAT-02204000 T022
4-1  MAT-03506000 T041	4-2  MAT-03505000 T041	4-3  MAT-03606000 T042	4-4  MAT-0360500A T042	4-5  CTMAS-11012 MFB-8600	4-6  CTMAS-11013 MFB-8600

FOR INDUSTRIAL SEWING MACHINES

1-1  MAS-11012 MFB-2600	1-2  MAS-11013 MFB-2600	1-3  MAS-11016 MFB-2600	1-4  MAS-11017 MFB-2600	1-5  B4121-052-A00 DLM-522	1-6  B4121-522-000 B4121-522-000(L) B4121-522-000(SKS7) DLM-522
2-1  B4145-530-B00 DMN-530	2-2  B4121-522-000(W) B4121-522-000(W)(SKH9)	2-3  305-00300 MFC-7605U75	2-4  303-65407 MFC-7605U75	2-5  B2406-373-OA0 MB-373	2-6  B2410-373-000 MB-373
3-1  B1235-373-000 MB-373	3-2  B1236-373-000 MB-373	3-3  B1237-373-000 MB-373	3-4  B2019-372-OA0 MB-373	3-5  B2015-372-OA0 MB-373	3-6  110-40052 DDL-5550-6/DDL-8700-6 DDL-9000A/B
4-1  110-40052/M Super Material	4-2  110-93259 DDL-5550H-6/DDL-8700-6	4-3  D2406-555-DOH DDL-5550-6/DDL-8700-6 DDL-9000A/B	4-4  D2406-555-DOH/M Super Material	4-5  D2405-555-B00-B DDL-555-5	4-6  110-40201 DDL-5550-6



1-1  D2401-530-D00 DMN-530-5	1-2  D2404-530-D00 DMN-530-5	1-3  114-09257 DDL-5550NH-7 DDL-8700-7	1-4  114-09257/M Super Material	1-5  114-09604 DDL-5550NH-7 DDL-8700-7	1-6  114-09604/M Super Material
2-1  40089755 DDL-8700J-7	2-2  110-95403 DDL-5550NH-7 DDL-8700-7	2-3  D2402-555-BAO DDL-555-5	2-4  D2402-555-BAB DDL-555-5	2-5  D2402-415-BAO DDL-555-5	2-6  D2406-555-B00 DDL-555-5
3-1  113-13053 DLN-5410-6	3-2  40044189 DDL-9000A/B	3-3  40050589 DDL-9000A/B	3-4  40044190 DDL-9000A/B MOL254	3-5  40050588 DDL-9000A/B	3-6  10502300 LK-1900
4-1  B2421-280-0A0 LK-1850	4-2  B2421-280-0A0/M Super Material	4-3  B2424-280-000 LK-1850	4-4  B2424-280-000/M Super Material	4-5  138-81255 LK-1952/1953/1954	4-6  B2421-210-AA0 AMS-210D

1-1  B2424-210-000 AMS-210D	1-2  B2421-210-000 AMS-215C	1-3  B2421-205-0A0 AMS-210C	1-4  B2424-210-A00 AMS-215C	1-5  110-42652 229-50356 DDL-8700 DDL-5550NH-7	1-6  D2408-555-CAO DDL-8700 DDL-5550NH-7
2-1  110-95601 DDL-8700	2-2  110-40508 DDL-8700	2-3  D3161-555-BAO DDL-8700	2-4  D2423-141-E00 DU-141-5	2-5  D2424-141-E00 DU-141-5	2-6  113-51400 DMN-5420-6
3-1  113-51509 DMN-5420-6	3-2  235-06009 LZ-2282N	3-3  235-06108 LZ-2282N	3-4  225-57557 LZ-2290A	3-5  225-57706 LZ-2290A	3-6  100-01709 LZ-2290
4-1  G5252-116-A00 APW-116	4-2  G5253-116-A00 APW-116	4-3  5649-116-A0A B116A	4-4  164-01002 APW-192	4-5  164-03008 APW-192	4-6  166-07301 APW-192



FOR INDUSTRIAL SEWING MACHINES

1-1  166-07400 APW-192	1-2  166-07509(B-1) APW-192	1-3  166-07608(B-2) APW-192	1-4  166-07707(C-1) APW-192	1-5  166-07806(C-2) APW-192	1-6  164-18600 APW-195
2-1  164-16109 APW-235	2-2  164-18709 APW-235	2-3  400-26155 APW-895	2-4  16409906 APW-895	2-5  400-33809 APW-895/896	2-6  400-33814 APW-895/896
3-1  400-23020 APW-895/896	3-2  40034923 MEB-3200	3-3  32020919 MEB-3200	3-4  320-18012 MEB-3200	3-5  32020703 MEB-3200	3-6  320-16107 MEB-3200
4-1  320-23319 MEB-3200	4-2  32023210 MEB-3200	4-3  32020505 MEB-3200	4-4  40015996 MEB-3200	4-5  32018509 MEB-3200	4-6  B1528-380-0A0 MH-380

FOR INDUSTRIAL SEWING MACHINES

1-1  40029004 UT25/UT33	1-2  13458500 UT25A/UT33A	1-3  23138209 MP-200N	1-4  23136005 MP-200N	1-5  B2408-761-000 LBH-761	1-6  B2406-761-0A0 LBH-761
2-1  B2406-771-0A0 LBH-780	2-2  B2408-771-000-A LBH-780	2-3  B2052-772-B00 LBH-783VB	2-4  D2050-772-BA0-A LBH-783VB	2-5  D9335-762-T00 LBH-762T/783VB	2-6  B2001-771-0A0 LBH-780
3-1  137-31161 LBH-790	3-2  137-35469 LBH-790	3-3  400-04255 LBH-1790	3-4  400-04311 LBH-1790	3-5  B2001-761-0A0 LBH-761	3-6  B2001-762-0A0 LBH-762
4-1  B2001-763-0A0 LBH-763	4-2  107-26305 LU-2216N-7	4-3  107-26404 LU-2216N-7	4-4  213-89200 LU-1560N-7	4-5  213-89309 LU-1560N-7	4-6  400-12403 LH-3528-7



FOR INDUSTRIAL SEWING MACHINES

1-1  400-12404 LH-3528-7	1-2  102-32403 LH-1162	1-3  102-11209 LH-1162/1152	1-4  102-11118 102-11100 LH-1162/1152	1-5  226-55302 LH-3128-7	1-6  228-20302 LH-3178-7
2-1  102-11605 LH-3128-7/LH-3178-7	2-2  40025949 LH-4128-7 LH-4168-7	2-3  07-125 DVK-1702BK	2-4  07-169 W802	2-5  07-206 DVK-1702BK	
3-1  07-432 BLX	3-2  07-507 WX8700	3-3  07-522 WX-EMK	3-4  07-529 DZX-3U	3-5  07-558 RX9800	3-6  07-596 RX
4-1  07-627 FSX6604	4-2  07-626 FSX6604	4-3  07-621 S-6604D	4-4  07-634 FSX/MH	4-5  07-631 FSX/MH	4-6  07-707 B2000C

FOR INDUSTRIAL SEWING MACHINES

1-1  56-860 UK2000	1-2  56-857 UK2000	1-3  07-505 WX8700	1-4  07-170 W8103	1-5  07-124 DVK-1702BK	1-6  07-406 DVK-1702BK
2-1  07-168 W802	2-2  07-570 RX	2-3  07-544 RX9800	2-4  07-545 RX9800	2-5  07-597	2-6  07-702 B2000C
3-1  07-703 B2000C	3-2  05-878	3-3  05-658 RX9800	3-4  05-812 RX9800	3-5  06-351 WX8800/RX9800	3-6  06-632 WX8800/RX9800
4-1  52-275 BK-20	4-2  52-288 BK-20	4-3  56-304	4-4  08-005 WX	4-5  08-055	4-6  05-548 FX4404



1-1  05-429 FX4404	1-2  05-447 FX4404	1-3  05-549 FX4404	KINGTEX  2210090242 FT39		1-5  6031218P700 SH6004
2-1  G6050114P700 SHG6005	2-2  2206110119 CTL6511	2-3  2120000715 UH8000	2-4  212010010 UH8000	2-5  4AG0050104 UH8000	2-6  2200850227 CT85
3-1  5240PF0109 N67	3-2  6031314C500 SH6004	3-3  G6050113C500 SHG6005	3-4  2120000708 UH8000	3-5  4AG0050103 UH8000	3-6  4AG0030104 UH8000
4-1  22100902372 FT39	4-2  2200850222 CT85	4-3  2200850222 CT85	4-4  2206110120 CT6500/CT9311	4-5  2273110120 CT6500/CT9311	4-6  G6050122D700 SHG6005

1-1  UTB0115 CT6500			1-2  UTB0207 CT6500		
2-1  UTB0118 CT6500	2-2  G20-22 SHG6005	2-3  UTB01-14 CT6500	MITSUBISHI  MF00A0834 LS2-180		2-5  MF00A0838 LS2-180
3-1  A141D676H01 LS2-180	3-2  MF02A0834 MF02A0834/M PLKA-2010/1710	3-3  MF02A0838 MF02A0838/M PLKA-2010/1710	3-4  MS07A0782 PLKA-2010/1710	3-5  MS07A0180 PLKA-2010/1710 DY-359	3-6  MG52A0834 DY-359
4-1  MG52A0838 DY-359	4-2  MP41B0838 LT-2230/2240/2250	4-3  MP41A0838 LT-2230/2240/2250	4-4  MN50B0838 LT2-250	4-5  MN50A0838 LT2-250	4-6  MS03B0838 MS03B0838/M PLKA/B-1006



1-1  MS03A0838 MS03A0838/M PLKA/B-1006	1-2  MF90B0838 LS2-190	1-3  MF90A0838 LS2-190	1-4  96-700535-05	1-5  96-700591-05		
MAUSER						
MERROW	2-1  6-91	2-2  6-91E	2-3  6-91K	2-4  6-90	2-5  6-90-C	
3-1  A-90-3 70-DB3	3-2  A-90-7 D4	PFAFF		3-4  91-189140-05 3822/3827	3-5  91-188294-05 3822/3827	91-140726-01
4-1  91-264338-15 1481/1483/1487/2481 2483/5463/5483/5489 3566/3568/3588/3819 3822/3827	4-2  91-141911-01	4-3  91-264240-05 1050/1180/951/953/563	4-4  91-014046-05 1050/1180	4-5  91-165505-05 333/335/337/461/463 469/481/483/487/489 1051/1053/1181/1183	4-6  91-263294-05 571/574	





















1-1  91-263139-05 571/574	1-2  91-263348-05 3734-12/31	1-3  95-774855-05 571/574	1-4  95-774853-05 571/574	1-5  95-774856-05 571/574	PEGASUS
2-1  202893/202893 (HSS) E/LS2/R	2-2  202295 E/LS2/R	2-3  2022950 M852-13	2-4  201127 E/LS2/R	2-5  B/B(HSS)	2-6  204161 L32/WS62
3-1  2041610 M832-70	3-2  204161A W664-35	3-3  137562 DC/DCP/DCM	3-4  200959 DCM-204	3-5  277009 EX5214	3-6  204351 L32-38
4-1  205609 R57L	4-2  208393 M722	4-3  213108 E51-210	4-4  213108A EX5100	4-5  236608/236608 (HSS) FS601/FS603	4-6  236606/236606 (HSS) FS601/FS603



FOR INDUSTRIAL SEWING MACHINES

1-1  236618/236618(HSS) FS601/FS603	1-2  138559 DCP-101	1-3  200971 DCM-204	1-4  202527A L32-38	1-5  202570 E/L/R	1-6  201121A ES2/LS2/RS3 EX3200/EX5200
2-1  201121ANS ES2-131	2-2  201121A0 M800	2-3  205890 EX3200/5200	2-4  277000 EX5214	2-5  210755 EX3200/EX5200	2-6  211662 EX5214H
3-1  211662A EX5214H	3-2  306394 WS62/W61/WS62	3-3  257573 W664-05	3-4  257573A W664-33	3-5  257574 W664-35	3-6  2B0010 W1662-35B/W2600-35B
4-1  301008 E52(KS)	4-2  301006 E52(KS)	4-3  301036 E32(KH)	4-4  301035 E32(KH)	4-5  179459-05 EX52/KS	4-6  179458-05 EX52/KS

FOR INDUSTRIAL SEWING MACHINES

1-1  303360 LS2(KS)	1-2  303363 LS2(KS)	1-3  308030 EX32	1-4  308026-91 EX32	1-5  340406 EX1023	1-6  340468 EX1023
2-1  201308 L32-38	2-2  202451 E32-420	2-3  350024 W762/UT	2-4  350018-91 W762/UT	2-5  350220 W664/UT	2-6  350218 W664/UT
3-1  350218(HSS) W664/UT	3-2  36278D 36200	3-3  350081 TK310	3-4  350083 TK310	3-5  305266 MC300	3-6  305267 MC300
4-1  301138 E32(TK)	4-2  303131 E32(TK)		4-3  270-113 27/327/527/627		



FOR INDUSTRIAL SEWING MACHINES

<p>1-1</p>  <p>270-113/1 202146-0-10 27/327/527/627</p>	<p>1-2</p>  <p>CT270-113/1 27/327/527/627</p>	<p>1-3</p>  <p>207015-2-00 27/327/527/627</p>	<p>1-4</p>  <p>2701-P9-113/1 203144-0-10 27/327/527/627</p>	<p>1-5</p>  <p>6378-113 302808-0-10 63</p>	<p>1-6</p>  <p>277-113 203012-0-10 27/327/527/627</p>
<p>2-1</p>  <p>CT277-113 27/327/527/627</p>	<p>2-2</p>  <p>207016-2-00 27/327/527/627</p>	<p>2-3</p>  <p>315507-0-00 63/64/65/155/261/262 263/264/73/91/93/94</p>	<p>2-4</p>  <p>279-113/1 203069-0-10 27/327/527/627</p>	<p>2-5</p>  <p>290-113SP 204693-0-11 27/327/527/627</p>	<p>2-6</p>  <p>207651-0-00 27/327/527</p>
<p>3-1</p>  <p>207025-2-00 27/327/527/627</p>	<p>3-2</p>  <p>306283-2-00 63/64/65/155/261/262 263/264/73/91/93/94</p>	<p>3-3</p>  <p>209344-2-00 27/327/527/627</p>	<p>3-4</p>  <p>350452-0-00 183-00-4</p>	<p>3-5</p>  <p>350453-0-00 183-00-4</p>	<p>3-6</p>  <p>CT290-113 207020-2-00 207020-2-01 27/327/527/627</p>
<p>4-1</p>  <p>290-113 204693-0-10 27/327/527/627</p>	<p>4-2</p>  <p>270-112 202142-0-10 27/327/527/627</p>	<p>4-3</p>  <p>290-112 203783-0-10 27/327/527/627</p>	<p>4-4</p>  <p>276B-112 202932-0-10 27/327/527/627</p>	<p>4-5</p>  <p>279-112 203066-0-10 27/327/527/627</p>	<p>4-6</p>  <p>209348-0-10 27/327/527/627</p>

FOR INDUSTRIAL SEWING MACHINES

<p>1-1</p>  <p>209356-0-00 27/327/527/627</p>	<p>1-2</p>  <p>209352-0-10 27/327/527/627</p>	<p>1-3</p>  <p>270-112/1 202143-0-10 27/327/527/627</p>	<p>1-4</p>  <p>277-112 203010-0-10 27/327/527/627</p>	<p>1-5</p>  <p>203759-0-10 27/327/527/627</p>	<p>1-6</p>  <p>209350-0-10 27/327/527/627</p>
<p>2-1</p>  <p>209354-0-10 27/327/527/627</p>	<p>2-2</p>  <p>209341-0-10 27/327/527/627</p>	<p>2-3</p>  <p>CT270-112 207000-2-00 27/327/527/627</p>	<p>2-4</p>  <p>209340-2-01 27/327/527/627</p>	<p>2-5</p>  <p>CT290-112 207003-2-00 27/327/527/627</p>	<p>2-6</p>  <p>CT276B-112 207001-2-00 27/327/527/627</p>
<p>3-1</p>  <p>CT279-112 207006-2-00 27/327/527/627</p>	<p>3-2</p>  <p>209347-2-01 27/327/527/627</p>	<p>3-3</p>  <p>209355-2-01 27/327/527/627</p>	<p>3-4</p>  <p>209351-2-01 27/327/527/627</p>	<p>3-5</p>  <p>209425-2-01 27/327/527/627</p>	<p>3-6</p>  <p>CT277-112 207002-2-00 27/327/527/627</p>
<p>4-1</p>  <p>207004-2-00 27/327/527/627</p>	<p>4-2</p>  <p>209357-2-01 27/327/527/627</p>	<p>4-3</p>  <p>209342-2-01 27/327/527/627</p>	<p>4-4</p>  <p>209341-0-00 27/327/527/627</p>	<p>4-5</p>  <p>209348-0-00 27/327/527/627</p>	<p>4-6</p>  <p>209352-0-00 27/327/527/627</p>



FOR INDUSTRIAL SEWING MACHINES





1-1  302807-0-10 63	1-2  302865-0-11 261/263/264	1-3  202194-0-11 27/327/527/627	1-4  929197-0-02	1-5  928531-2-00	1-6  928530-2-00
	2-1  CRL09J C007J	2-2  KR35 747/700K	2-3  KR35C 757	2-4  FBQ30 F007E/FBQ	2-5  FR40 HF008/FBQ
3-1  FR40D F007E/FBQ	3-2  FR40K F007K/FR	3-3  FR40J F007J/FR	3-4  KR55 700FS	3-5  KR23 747	3-6  KR23A 747
4-1  KR23C 757	4-2  AN02 747K/AN	4-3  AN12 747K/AN	4-4  FR34B HF008/FBQ	4-5  FR34 HF008/FBQ	4-6  FR134 F007J

FOR INDUSTRIAL SEWING MACHINES

1-1  FR34H F007	1-2  CR26J C007J	1-3  CR26H C007E/CRL	1-4  CRL03 C007E/CRL	1-5  CRL03H C007H/CRL	1-6  CRL03J C007E/CRL
2-1  CR26	2-2  CRL103 C007J	2-3  CRL104 C007J/C007JD	2-4  CRL04J C007E/CRL	2-5  CRL04H C007H	2-6  LR21 L818F-RM1
3-1  UT317 C007/F007	3-2  UT318 C007/F007	3-3  UT507 C007J	3-4  UT506 C007J	3-5  UT758 F/C/S007	3-6  UT759 F/C/S007
4-1  VT05 747/VT	4-2  VT04 747/VT	4-3  CT19 747/CT	4-4  CT18-1 747/CT	4-5  CT203 700K/CT	4-6  CT202 700K/CT



1-1  DT06 700D/FT	1-2  DT05 700D/FT	1-3  FV08 F007J/FV	1-4  VT205 700K/VT	1-5  VT206 700K/VT	1-6  LU02 L818F-M1
2-1  LU05 L818F/M1	2-2  LU04 L818F-M1	2-3  LU602 L819	2-4  LU605 L819	2-5  LU101 L818	2-6  LU103 L818
3-1  LU501 L818	3-2  LU503 L818	3-3  BG130D PK533	3-4  BG127 PK533	3-5  UM105 T828	3-6  UM104 T828
4-1  BK10F 700K	4-2  KS24 700K	4-3  A702 AA	4-4  A703 AA	4-5  RU10 351/991T	4-6  RU14 351/991T

















1-1  EC05 700	1-2  EC02 700		1-3  SUN STAR GP-010017-00 SC7310		
2-1  GP-010014-00 SC7310	2-2  10-006A-235B KM-250	2-3  10-001A-2700 KM-250	2-4  10-005A-2700 KM-2300/KM-250	2-5  10-106A-2700 KM-250	2-6  10-101A-2700 KM-250
3-1  10-006A-120H SPS/A-B1201	3-2  10-001A-120H SPS/A-B1201	3-3  10-002A-7507 KM-757	3-4  10-007A-7507 KM-757	3-5  10S047S-306H SPS/A-1306-HS SPS/B-1306-HS	3-6  10S045S-306H SPS/A-1306-HS SPS/B-1306-HS
4-1  10-008A-64L7 KM-640	4-2  10-001A-64L7 KM-640	4-3  GP-001548-00 SC7300	4-4  GP-001544-00 SC7300	4-5  10-011A-8677 KM957-7/KM967-7	4-6  10-002A-8677 KM957-7/KM967-7



FOR INDUSTRIAL SEWING MACHINES



1-1  42309 81	1-2  42305 81	1-3  412749 14U	1-4  410295 14U	1-5  164728 246.460	1-6  550449 14SH654
2-1  412585 14U	2-2  164550	2-3  548845 299U.T.T	2-4  548851 299U123	2-5  253775 299U123	2-6  548865 299U123
3-1  253647 299U123	3-2  544533 299U	3-3  411088 457U	3-4  502670 457C/457U	3-5  540741 591	3-6  540760 591
REECE  140888-001 EF2-B531	4-1  REECE38	4-2  REECE38-1	4-3  46-1001-5-289 38	4-4  46-1125-5-000 45 REECE 46	4-5  157

FOR INDUSTRIAL SEWING MACHINES

1-1  10-1197-1 104	TOYOTA  2111407-553-A AD-158	1-2  2111407-553-B AD-158	1-3  2111407-553-B AD-158		
2-1  0252072-145-B AD-157	2-2  2111417-556-B AD-158	2-3  0252052-141-C AD-157			
3-1  1650004-229 6300/6600	UNION SPECIAL  39549 39500	3-2  39549 39500	3-3  34749A		
4-1  39549N 39500	4-2  39549J 39500	4-3  39249A 39200	4-4  36250 36200	4-5  39270A 39200	4-6  39270D 39200



FOR INDUSTRIAL SEWING MACHINES

1-1  39270E 39200	1-2  39270K 39200	1-3  36270 36200	1-4  36270B 36200	1-5  39570 39500	1-6  CT39570 39500
2-1  39570J 39500	2-2  39570K 39500	2-3  39570L 39500	2-4  35796B 35700/35800	2-5  35796C 35700/35800	
3-1  2100167 AZ-8000	3-2  2110305 AZ8400	3-3  2121111 AZF-8600	3-4  22195 Z-6000	3-5  30421 DCZ-2000	3-6  35285 DCZ-341
4-1  37538 DC-100	4-2  6200097 CZ6000/CZ6500	4-3  3101026 VC-2685	4-4  3101633 VC-2629	4-5  3110038 VC-3611	4-6  3201062 VF-2509

FOR INDUSTRIAL SEWING MACHINES

1-1  95277 DW-1359	1-2  3501026 VG2735	1-3  3021109 3021109(HSS) FD-62-12	1-4  3021111 3021111(HSS) FD-62-12	1-5  68185/68185(HSS) FD-62-01	1-6  68121/68121(HSS) FD-62-01
2-1  68184/68184(HSS) FD-62-01	2-2  37472/37472(HSS) DCY-104	2-3  37514 DC-100	2-4  37469/37469(HSS) DCY-104	2-5  CT37469 DCY-104	2-6  36415 DCZ-200
3-1  6200022 AZ8120G	3-2  20496 Z6000	3-3  2150256 AZ8120G	3-4  32914 DCZ-200	3-5  32914-7 DCZ-200	3-6  20491 Z6000
4-1  2121107 AZF-8600	4-2  35286 DCZ-341	4-3  95276 DW-1359	4-4  3101465 VC-2629	4-5  3101028 VC-2685	4-6  3110037 VC-3611



1-1  3501032 VG2735	1-2  3501597 VG-3721	1-3  3501535 VG-3721	1-4  3501534 VG-3721	1-5  3501596 VG3721-8	1-6  20271 AZ6000H/AZ8000H VC2700M/VG3721
2-1  32706 DCZ-200	2-2  6200020 LG1500	2-3  3101801 VG3721/VC2700	2-4  3101802 VG3721/VC2700	2-5  3100513 VC-2713/UT	2-6  CT3100512 VC-2713/UT
3-1  3100512 VC-2713/UT	3-2  94411 95399/DW-1367	3-3  94417 DW-1367	3-4  6500455 VT1500	3-5  6500456 VT1500	3-6  6500457 VT1500
4-1  3101699 VC2700/VC2608	4-2  3101700 VC2700/VC2608	4-3  5000261 LG2200	4-4  5000262 LG2200	4-5  2101220 AZ8020/KH	4-6  2101221 AZ8020/KH

1-1  2111056 AZ8020	1-2  2111055 AZ8020	1-3  2101156 AZ-8500	1-4  2101155 AZ-8500	1-5  3021060 FD62-01	1-6  3021061 FD62-01
2-1  2114013 AZ8451/AZ8451-1	2-2  2114012 AZ8451/AZ8451-1	2-3  3112005	2-4  3112006	NEW LONG 	
3-1  246071 NP-7	OTHERS 		3-3  HS340	3-4  AF702/11702 AA	3-5  AF703/11703 AA
4-1  613140	4-2  81000670 8515	4-3  HS901	4-4  103-019 ACF-103N-3	4-5  HS920	4-6  HS030



FOR INDUSTRIAL SEWING MACHINES

1-1  HS130	1-2  2122207-113	1-3  81000669 8515	1-4  ABLE/HB-90-L	1-5  ABLE/HB-90-S	1-6  HS910
2-1  B4401	2-2  B4471	2-3  A105-2100	2-4  A105-3100	2-5  103-002 ACF-103N-3	2-6  DSK27
3-1  DSK25	3-2  HS4498	3-3  HS4499	3-4  21-4001 100SF/100SFZ	3-5  HS861	3-6  HS440
4-1  03-012	4-2  32-2047-1-001	4-3  32-2047-1-002	4-4  21-3003 PL-9-9	4-5  37231-033	4-6  HS400

FOR INDUSTRIAL SEWING MACHINES

1-1  HS872 Leather Cutting Knife	1-2  HS782 Leather Cutting Knife	1-3  1039896 Leather Cutting Knife	1-4  LECTRA 715 Leather Cutting Knife	1-5  HZ3B42 Leather Cutting Knife	1-6  1039895 Leather Cutting Knife
2-1  R151LIGIA Leather Cutting Knife	2-2  ER98 Leather Cutting Knife	2-3  ER99 Leather Cutting Knife	2-4  1039999 Leather Cutting Knife	2-5  NAVALHA GP1 Leather Cutting Knife	2-6  ERK35 Leather Cutting Knife
3-1  1802 Leather Cutting Knife	3-2  HZ4N Leather Cutting Knife	3-3  PIDAO Leather Knife	3-4  HZSK.H. Leather Cutting Knife	3-5  2560 AK82800	3-6  2569 AK82800
4-1  1-8A(3mm)	4-2  1-11(3mm)	4-3  1-8(5mm)	4-4  114-023-000 LSM-150	4-5  25626	4-6  25655



FOR INDUSTRIAL SEWING MACHINES





1-1  HS076	1-2  HS176	1-3  559031310	1-4  559032010																																																														
2-1  HS562 ACE		2-2  HS462 ACE																																																															
3-1  S35436-001 DH4-B981/RH9820		3-2  S35436-001/M Super Material	3-3  S35437-001 DH4-B980	3-4  S35437-001/M Super Material	3-5  S41345-001 RH9820																																																												
4-1  DH4-B980	4-2  B981/RH9820	4-3  B980/RH9820																																																															
<table border="1"> <tr><td>S35092-001</td><td>20m/m</td></tr> <tr><td>S37195-001</td><td>22m/m</td></tr> <tr><td>S37196-001</td><td>24m/m</td></tr> <tr><td>S37197-001</td><td>26m/m</td></tr> <tr><td>S37198-001</td><td>28m/m</td></tr> <tr><td>S37199-001</td><td>30m/m</td></tr> <tr><td>S35093-001</td><td>38m/m</td></tr> </table>		S35092-001	20m/m	S37195-001	22m/m	S37196-001	24m/m	S37197-001	26m/m	S37198-001	28m/m	S37199-001	30m/m	S35093-001	38m/m	<table border="1"> <tr><td>S37703-001</td><td>14m/m</td></tr> <tr><td>S37704-001</td><td>16m/m</td></tr> <tr><td>S37705-001</td><td>18m/m</td></tr> <tr><td>S37706-001</td><td>20m/m</td></tr> <tr><td>S37707-001</td><td>22m/m</td></tr> <tr><td>S37708-001</td><td>24m/m</td></tr> <tr><td>S37709-001</td><td>26m/m</td></tr> <tr><td>S42053-001</td><td>28m/m</td></tr> <tr><td>S35479-001</td><td>50m/m</td></tr> </table>		S37703-001	14m/m	S37704-001	16m/m	S37705-001	18m/m	S37706-001	20m/m	S37707-001	22m/m	S37708-001	24m/m	S37709-001	26m/m	S42053-001	28m/m	S35479-001	50m/m	<table border="1"> <tr><td>S37209-001</td><td>14m/m</td></tr> <tr><td>S37208-001</td><td>16m/m</td></tr> <tr><td>S37194-001</td><td>18m/m</td></tr> <tr><td>S35092-001</td><td>20m/m</td></tr> <tr><td>S37195-001</td><td>22m/m</td></tr> <tr><td>S37196-001</td><td>24m/m</td></tr> <tr><td>S37197-001</td><td>26m/m</td></tr> <tr><td>S37198-001</td><td>28m/m</td></tr> <tr><td>S37199-001</td><td>30m/m</td></tr> <tr><td>S37200-001</td><td>32m/m</td></tr> <tr><td>S37201-001</td><td>34m/m</td></tr> <tr><td>S37202-001</td><td>36m/m</td></tr> <tr><td>S35093-001</td><td>38m/m</td></tr> <tr><td>SA7106-001</td><td>42m/m</td></tr> </table>		S37209-001	14m/m	S37208-001	16m/m	S37194-001	18m/m	S35092-001	20m/m	S37195-001	22m/m	S37196-001	24m/m	S37197-001	26m/m	S37198-001	28m/m	S37199-001	30m/m	S37200-001	32m/m	S37201-001	34m/m	S37202-001	36m/m	S35093-001	38m/m	SA7106-001	42m/m
S35092-001	20m/m																																																																
S37195-001	22m/m																																																																
S37196-001	24m/m																																																																
S37197-001	26m/m																																																																
S37198-001	28m/m																																																																
S37199-001	30m/m																																																																
S35093-001	38m/m																																																																
S37703-001	14m/m																																																																
S37704-001	16m/m																																																																
S37705-001	18m/m																																																																
S37706-001	20m/m																																																																
S37707-001	22m/m																																																																
S37708-001	24m/m																																																																
S37709-001	26m/m																																																																
S42053-001	28m/m																																																																
S35479-001	50m/m																																																																
S37209-001	14m/m																																																																
S37208-001	16m/m																																																																
S37194-001	18m/m																																																																
S35092-001	20m/m																																																																
S37195-001	22m/m																																																																
S37196-001	24m/m																																																																
S37197-001	26m/m																																																																
S37198-001	28m/m																																																																
S37199-001	30m/m																																																																
S37200-001	32m/m																																																																
S37201-001	34m/m																																																																
S37202-001	36m/m																																																																
S35093-001	38m/m																																																																
SA7106-001	42m/m																																																																

FOR INDUSTRIAL SEWING MACHINES

1-1  S41346-001 RH9820	1-2  S41347-001 RH9820	DURKOPP  557 1677		1-4  558 2551 558	1-5  558 2561 558
2-1  558 2562 557	2-2  558 2562/M Super Material	2-3  558 2563 558	2-4  558 2564 558	2-5  558 2564/M Super Material	2-6  578 3363 578
3-1  578 3365 578	3-2  0580 330390 559	3-3  0580 330380 559	3-4  5783366	3-5  605340	3-6  548804
4-1  558	4-2  0580 330040 16m/m 0580 330050 18m/m 0580 330060 20m/m 0580 330070 22m/m 0580 330080 24m/m 0580 330090 26m/m 0580 330100 28m/m 0580 330110 30m/m 0580 330120 32m/m 0580 330130 34m/m 0580 330140 36m/m 0580 330150 38m/m		4-3  578 3283 14m/m 578 3284 16m/m 578 3285 18m/m 578 3286 20m/m 578 3287 22m/m 578 3288 24m/m 578 3289 26m/m 578 3290 28m/m 578 3291 30m/m 578 3292 32m/m 578 3293 34m/m 578 3294 36m/m		



<p><b>1-1</b></p>  <p>14041206 MEB-3200</p>		<p><b>1-2</b></p>  <p>14041206/M Super Material</p>		<p><b>1-3</b></p>  <p>MEB-3200</p> <table border="1"> <tr> <td>32063505</td> <td>10m/m</td> <td>32063000</td> <td>20m/m</td> <td>32062507</td> <td>30m/m</td> </tr> <tr> <td>32063406</td> <td>12m/m</td> <td>32062903</td> <td>22m/m</td> <td>32062408</td> <td>32m/m</td> </tr> <tr> <td>32063307</td> <td>14m/m</td> <td>32062804</td> <td>24m/m</td> <td>32062309</td> <td>34m/m</td> </tr> <tr> <td>32063208</td> <td>16m/m</td> <td>32062705</td> <td>26m/m</td> <td>32062200</td> <td>36m/m</td> </tr> <tr> <td>32063109</td> <td>18m/m</td> <td>32062606</td> <td>28m/m</td> <td>32062101</td> <td>38m/m</td> </tr> </table>				32063505	10m/m	32063000	20m/m	32062507	30m/m	32063406	12m/m	32062903	22m/m	32062408	32m/m	32063307	14m/m	32062804	24m/m	32062309	34m/m	32063208	16m/m	32062705	26m/m	32062200	36m/m	32063109	18m/m	32062606	28m/m	32062101	38m/m								
32063505	10m/m	32063000	20m/m	32062507	30m/m																																								
32063406	12m/m	32062903	22m/m	32062408	32m/m																																								
32063307	14m/m	32062804	24m/m	32062309	34m/m																																								
32063208	16m/m	32062705	26m/m	32062200	36m/m																																								
32063109	18m/m	32062606	28m/m	32062101	38m/m																																								
<p><b>2-1</b></p>  <p>113-043-000 LSM-150</p>		<p><b>2-2</b></p>  <table border="1"> <tr> <td>111-150-000</td> <td>13m/m</td> </tr> <tr> <td>111-151-000</td> <td>16m/m</td> </tr> <tr> <td>111-152-000</td> <td>19m/m</td> </tr> <tr> <td>111-153-000</td> <td>22m/m</td> </tr> <tr> <td>111-154-000</td> <td>25m/m</td> </tr> <tr> <td>111-155-000</td> <td>28m/m</td> </tr> <tr> <td>111-156-000</td> <td>32m/m</td> </tr> </table>		111-150-000	13m/m	111-151-000	16m/m	111-152-000	19m/m	111-153-000	22m/m	111-154-000	25m/m	111-155-000	28m/m	111-156-000	32m/m	<p><b>2-3</b></p>  <p>10-3072-0-024 101</p>																											
111-150-000	13m/m																																												
111-151-000	16m/m																																												
111-152-000	19m/m																																												
111-153-000	22m/m																																												
111-154-000	25m/m																																												
111-155-000	28m/m																																												
111-156-000	32m/m																																												
<p><b>3-1</b></p>  <p>10-3072-0-024/M Super Material</p>		<p><b>3-2</b></p>  <p>10-3072-0-014 101</p>		<p><b>3-3</b></p>  <p>10-3072-0-014/M Super Material</p>		<p><b>3-4</b></p>  <p>17-0064-5-864 3/SCA 100</p>		<p><b>3-5</b></p>  <p>17-0064-5-864 3/SCB 100</p>		<p><b>3-6</b></p>  <p>17-0064-5-863</p>																																			
<p><b>4-1</b></p>  <table border="1"> <tr> <td>10-1069-0-051</td> <td>7/8"</td> </tr> <tr> <td>10-1069-0-052</td> <td>1"</td> </tr> <tr> <td>10-1069-0-054</td> <td>1 1/4"</td> </tr> <tr> <td>10-1069-0-055</td> <td>1 3/8"</td> </tr> <tr> <td>10-1069-0-056</td> <td>1 1/2"</td> </tr> <tr> <td>10-1069-0-060</td> <td>2"</td> </tr> </table> <p>101</p>		10-1069-0-051	7/8"	10-1069-0-052	1"	10-1069-0-054	1 1/4"	10-1069-0-055	1 3/8"	10-1069-0-056	1 1/2"	10-1069-0-060	2"	<p><b>4-2</b></p>  <table border="1"> <tr> <td>17-0064-5-951</td> <td>13m/m</td> </tr> <tr> <td>17-0064-5-849</td> <td>16m/m</td> </tr> <tr> <td>17-0064-5-852</td> <td>22m/m</td> </tr> <tr> <td>17-0064-5-854</td> <td>26m/m</td> </tr> <tr> <td>17-0064-5-855</td> <td>29m/m</td> </tr> <tr> <td>17-0064-5-856</td> <td>32m/m</td> </tr> <tr> <td>17-0064-5-858</td> <td>38m/m</td> </tr> </table> <p>100</p>		17-0064-5-951	13m/m	17-0064-5-849	16m/m	17-0064-5-852	22m/m	17-0064-5-854	26m/m	17-0064-5-855	29m/m	17-0064-5-856	32m/m	17-0064-5-858	38m/m	<p><b>4-3</b></p>  <table border="1"> <tr> <td>10-1069-0-001</td> <td>1/2"</td> </tr> <tr> <td>10-1069-0-002</td> <td>5/8"</td> </tr> <tr> <td>10-1069-0-003</td> <td>3/4"</td> </tr> <tr> <td>10-1069-0-004</td> <td>7/8"</td> </tr> <tr> <td>10-1069-0-005</td> <td>1"</td> </tr> <tr> <td>10-1069-0-006</td> <td>1 1/8"</td> </tr> <tr> <td>10-1069-0-007</td> <td>1 1/4"</td> </tr> </table> <p>104</p>		10-1069-0-001	1/2"	10-1069-0-002	5/8"	10-1069-0-003	3/4"	10-1069-0-004	7/8"	10-1069-0-005	1"	10-1069-0-006	1 1/8"	10-1069-0-007	1 1/4"
10-1069-0-051	7/8"																																												
10-1069-0-052	1"																																												
10-1069-0-054	1 1/4"																																												
10-1069-0-055	1 3/8"																																												
10-1069-0-056	1 1/2"																																												
10-1069-0-060	2"																																												
17-0064-5-951	13m/m																																												
17-0064-5-849	16m/m																																												
17-0064-5-852	22m/m																																												
17-0064-5-854	26m/m																																												
17-0064-5-855	29m/m																																												
17-0064-5-856	32m/m																																												
17-0064-5-858	38m/m																																												
10-1069-0-001	1/2"																																												
10-1069-0-002	5/8"																																												
10-1069-0-003	3/4"																																												
10-1069-0-004	7/8"																																												
10-1069-0-005	1"																																												
10-1069-0-006	1 1/8"																																												
10-1069-0-007	1 1/4"																																												

<p><b>1-1</b></p>  <table border="1"> <tr> <td>REECE10018MM</td> </tr> <tr> <td>REECE10019MM</td> </tr> <tr> <td>REECE10020MM</td> </tr> <tr> <td>REECE10024MM</td> </tr> <tr> <td>REECE10029MM</td> </tr> <tr> <td>REECE10030MM</td> </tr> <tr> <td>REECE10035MM</td> </tr> </table>						REECE10018MM	REECE10019MM	REECE10020MM	REECE10024MM	REECE10029MM	REECE10030MM	REECE10035MM																																	
REECE10018MM																																													
REECE10019MM																																													
REECE10020MM																																													
REECE10024MM																																													
REECE10029MM																																													
REECE10030MM																																													
REECE10035MM																																													
<p><b>2-1</b></p>  <p>548936 299U253SW</p>		<p><b>2-2</b></p>  <p>544599 299U253SW</p>		<p><b>2-3</b></p>  <p>548886 299U253SW</p>		<p><b>2-4</b></p>  <p>548992 299U253SW</p>		<p><b>2-5</b></p>  <p>548935 299U253SW</p>																																					
<p><b>3-1</b></p>  <p>255344 299U253SW</p>		<p><b>3-2</b></p>  <p>548066 299U253SW</p>		<p><b>3-3</b></p>  <p>544600 299U253SW</p>		<p><b>3-4</b></p>  <table border="1"> <tr> <td>544587</td> <td>3/4</td> </tr> <tr> <td>544588</td> <td>7/8</td> </tr> <tr> <td>544589</td> <td>1</td> </tr> </table> <p>299U253SW</p>		544587	3/4	544588	7/8	544589	1	<p><b>3-5</b></p>  <table border="1"> <tr> <td>544593</td> <td>5/8</td> </tr> <tr> <td>544595</td> <td>7/8</td> </tr> <tr> <td>544596</td> <td>1</td> </tr> </table> <p>299U253SW</p>		544593	5/8	544595	7/8	544596	1	<p><b>3-6</b></p>  <table border="1"> <tr> <td>548837</td> <td>3/4</td> </tr> <tr> <td>548838</td> <td>7/8</td> </tr> </table> <p>299U253SW</p>		548837	3/4	548838	7/8																		
544587	3/4																																												
544588	7/8																																												
544589	1																																												
544593	5/8																																												
544595	7/8																																												
544596	1																																												
548837	3/4																																												
548838	7/8																																												
<p><b>4-1</b></p>  <table border="1"> <tr> <td>548762</td> <td>1/2"</td> <td>548767</td> <td>1 1/8"</td> </tr> <tr> <td>548763</td> <td>5/8"</td> <td>548768</td> <td>1 1/4"</td> </tr> <tr> <td>548764</td> <td>3/4"</td> <td>548769</td> <td>1 3/8"</td> </tr> <tr> <td>548765</td> <td>7/8"</td> <td>548770</td> <td>1 1/2"</td> </tr> <tr> <td>548766</td> <td>1"</td> <td>548771</td> <td>1 5/8"</td> </tr> </table> <p>299U</p>			548762	1/2"	548767	1 1/8"	548763	5/8"	548768	1 1/4"	548764	3/4"	548769	1 3/8"	548765	7/8"	548770	1 1/2"	548766	1"	548771	1 5/8"	<p><b>4-2</b></p>  <table border="1"> <tr> <td>548752</td> <td>1/2"</td> <td>548757</td> <td>1 1/8"</td> </tr> <tr> <td>548753</td> <td>5/8"</td> <td>548758</td> <td>1 1/4"</td> </tr> <tr> <td>548754</td> <td>3/4"</td> <td>548759</td> <td>1 3/8"</td> </tr> <tr> <td>548755</td> <td>7/8"</td> <td>548760</td> <td>1 1/2"</td> </tr> <tr> <td>548756</td> <td>1"</td> <td>548761</td> <td>1 5/8"</td> </tr> </table>			548752	1/2"	548757	1 1/8"	548753	5/8"	548758	1 1/4"	548754	3/4"	548759	1 3/8"	548755	7/8"	548760	1 1/2"	548756	1"	548761	1 5/8"
548762	1/2"	548767	1 1/8"																																										
548763	5/8"	548768	1 1/4"																																										
548764	3/4"	548769	1 3/8"																																										
548765	7/8"	548770	1 1/2"																																										
548766	1"	548771	1 5/8"																																										
548752	1/2"	548757	1 1/8"																																										
548753	5/8"	548758	1 1/4"																																										
548754	3/4"	548759	1 3/8"																																										
548755	7/8"	548760	1 1/2"																																										
548756	1"	548761	1 5/8"																																										





YUVARLAK KUMAŞ KESİM MOTORU  
KUMAŞ KESİM MOTORU DİK  
HIZAR  
İLİK  
CAD KESİM  
KUMAŞ KESİM

# BIÇAKLARI

ROUND  
STRAIGHT  
BAND  
BUTTON HOLE  
CAD CUTTING  
CLOTH SLITTING

# KNIVES

FOR END CUTTER MACHINES  
FOR CUTTING MACHINES



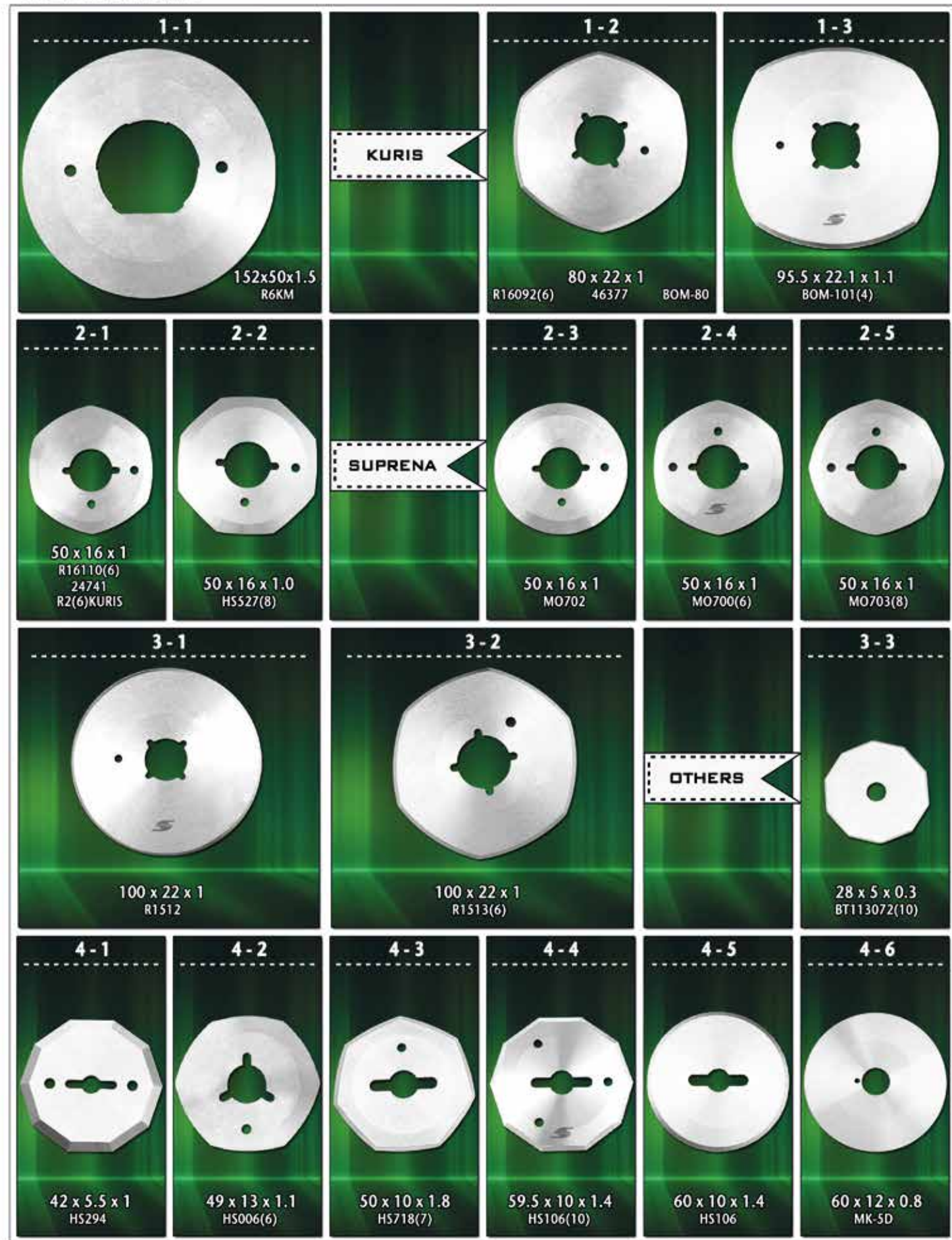
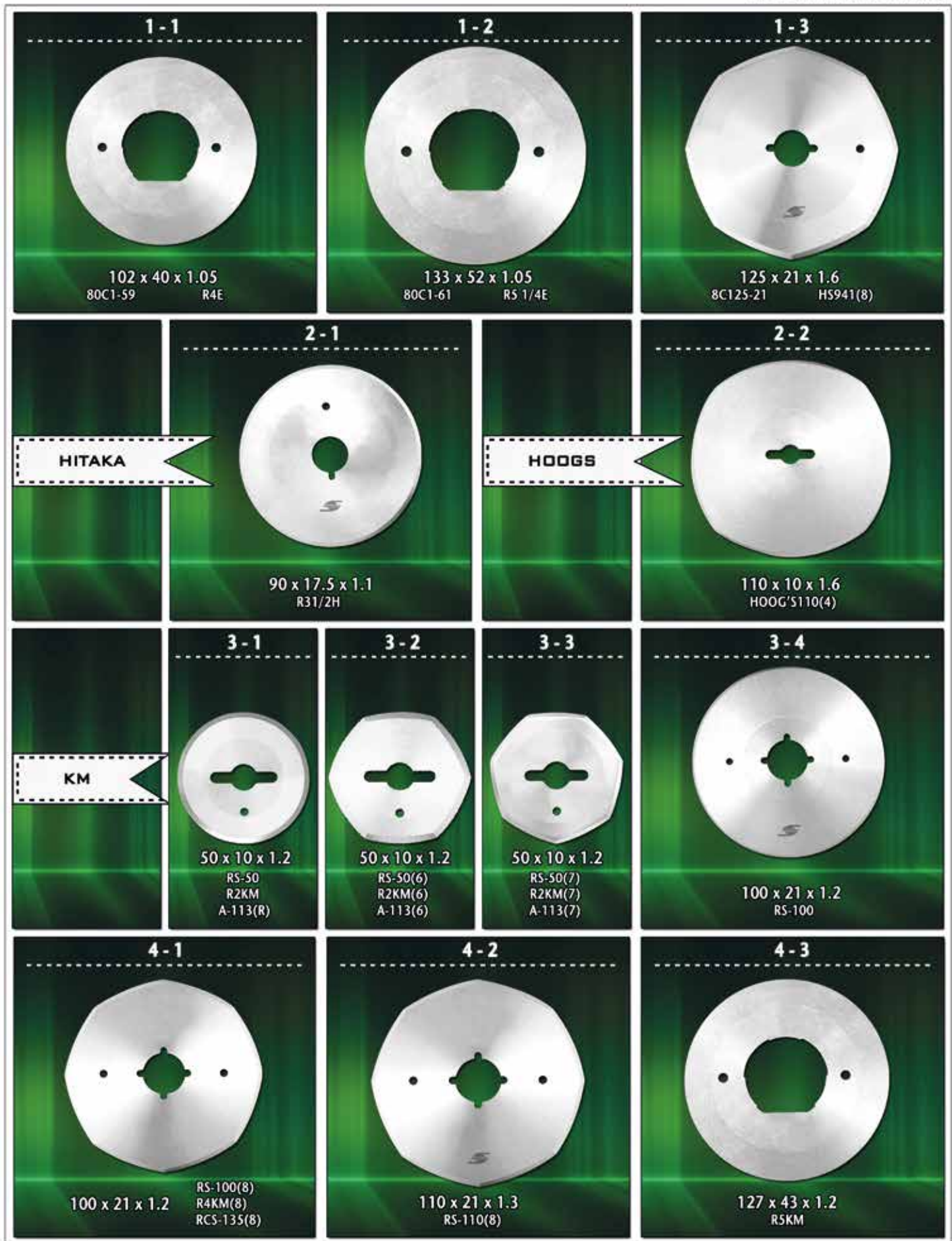



FOR  
END CUTTER MACHINES

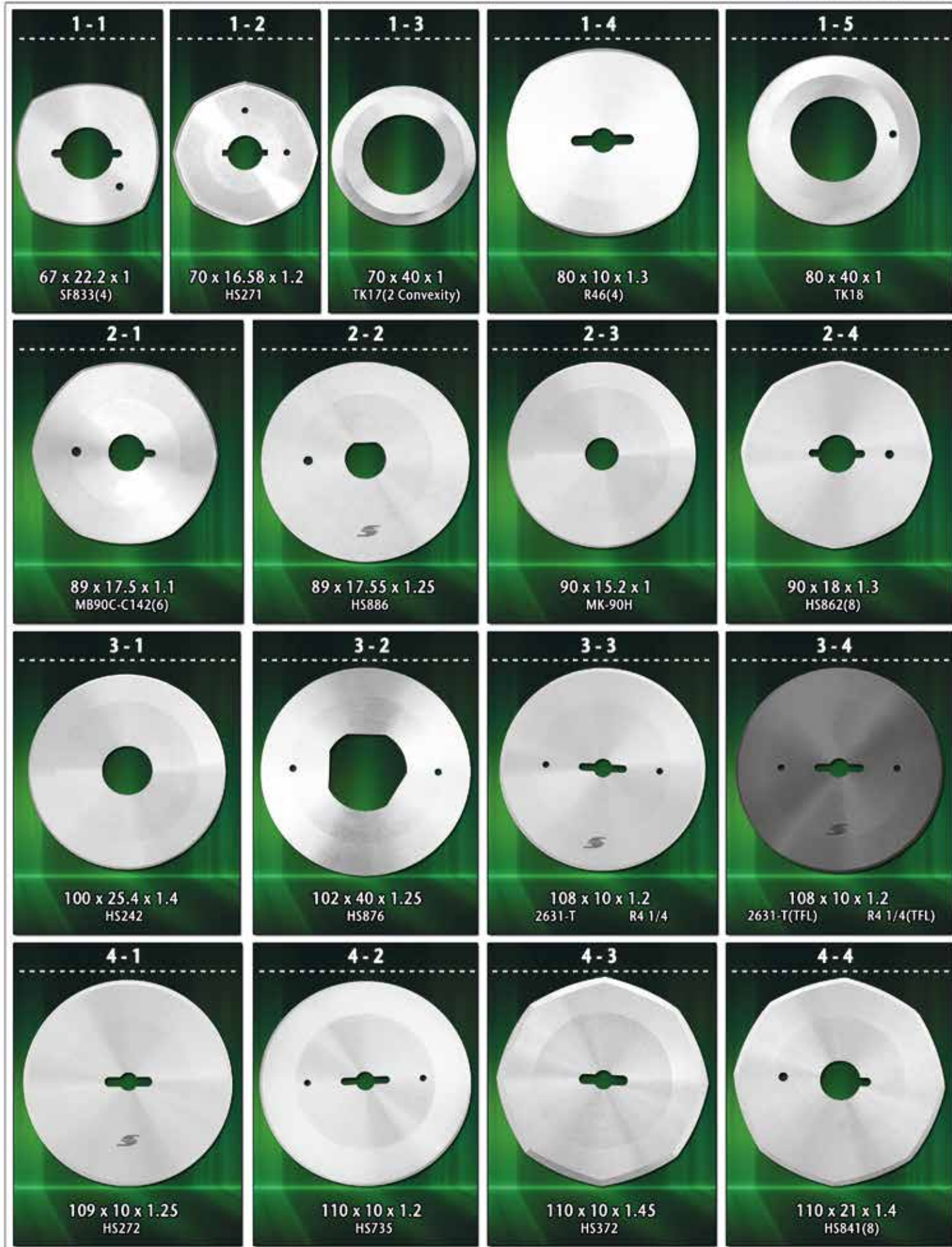

FOR  
END CUTTER MACHINES

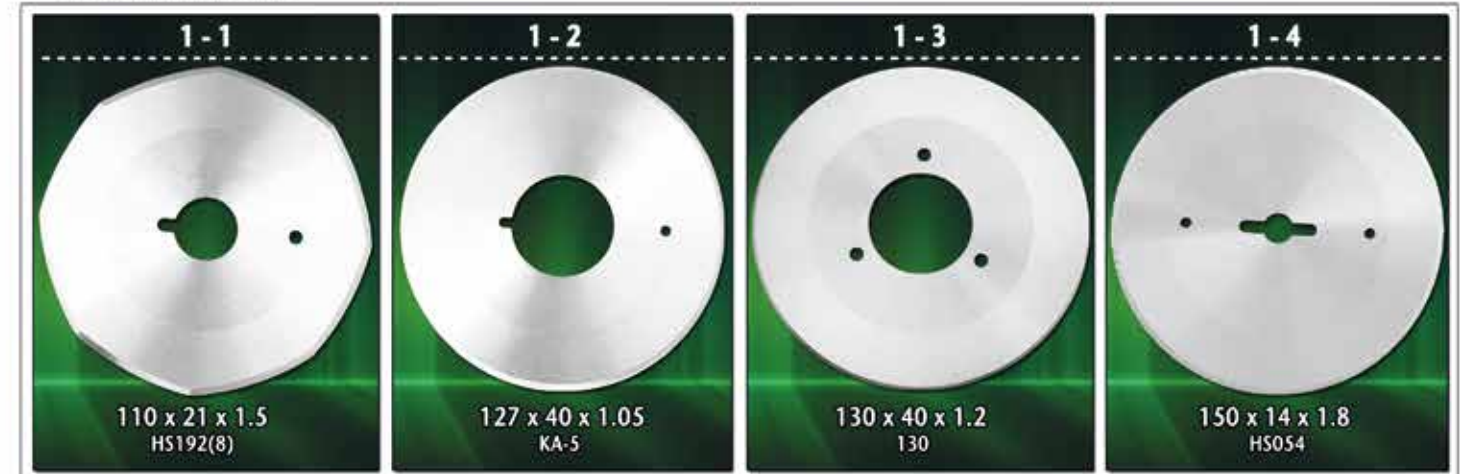

LOWER KNIVES FOR ROUND KNIFE

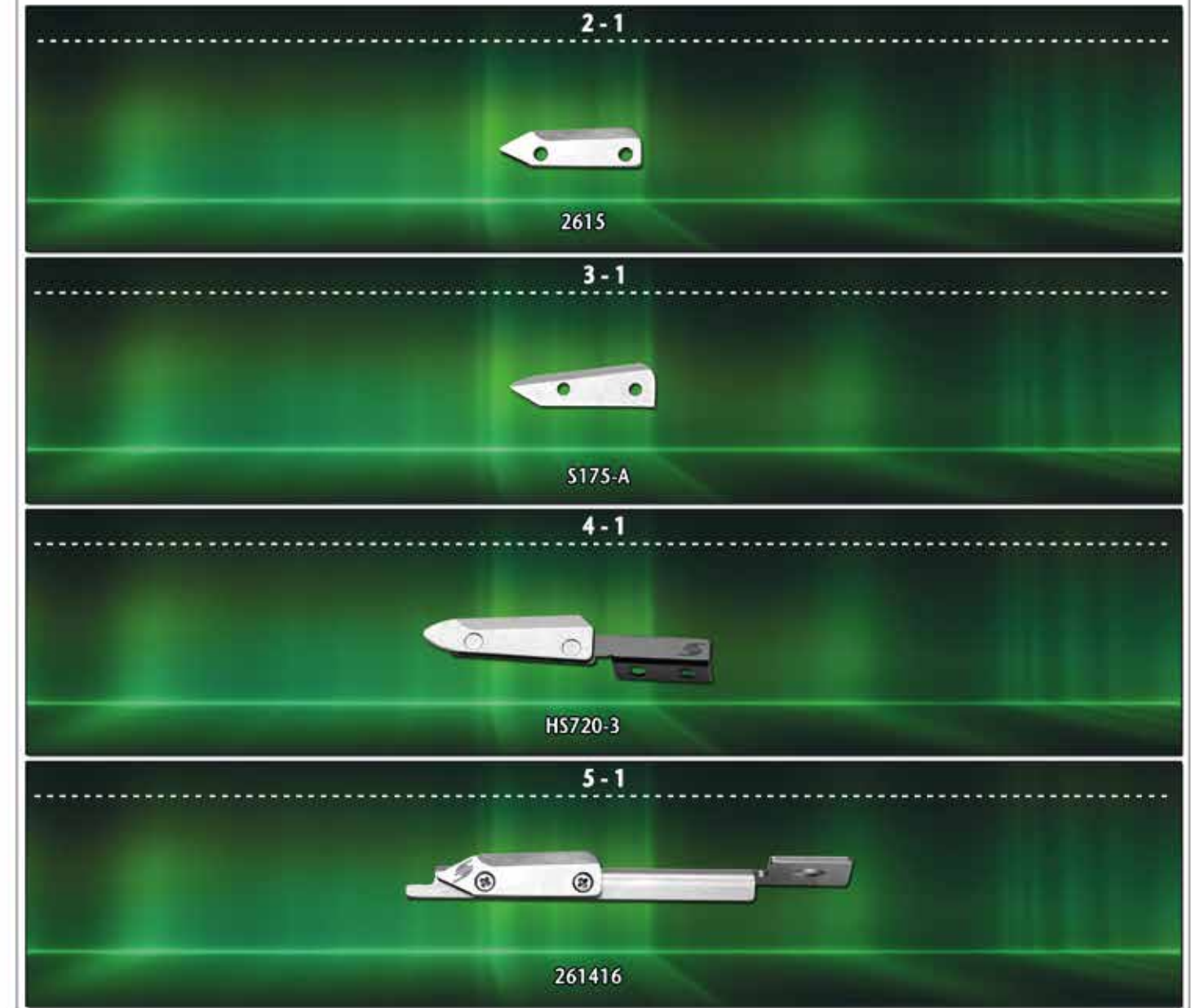



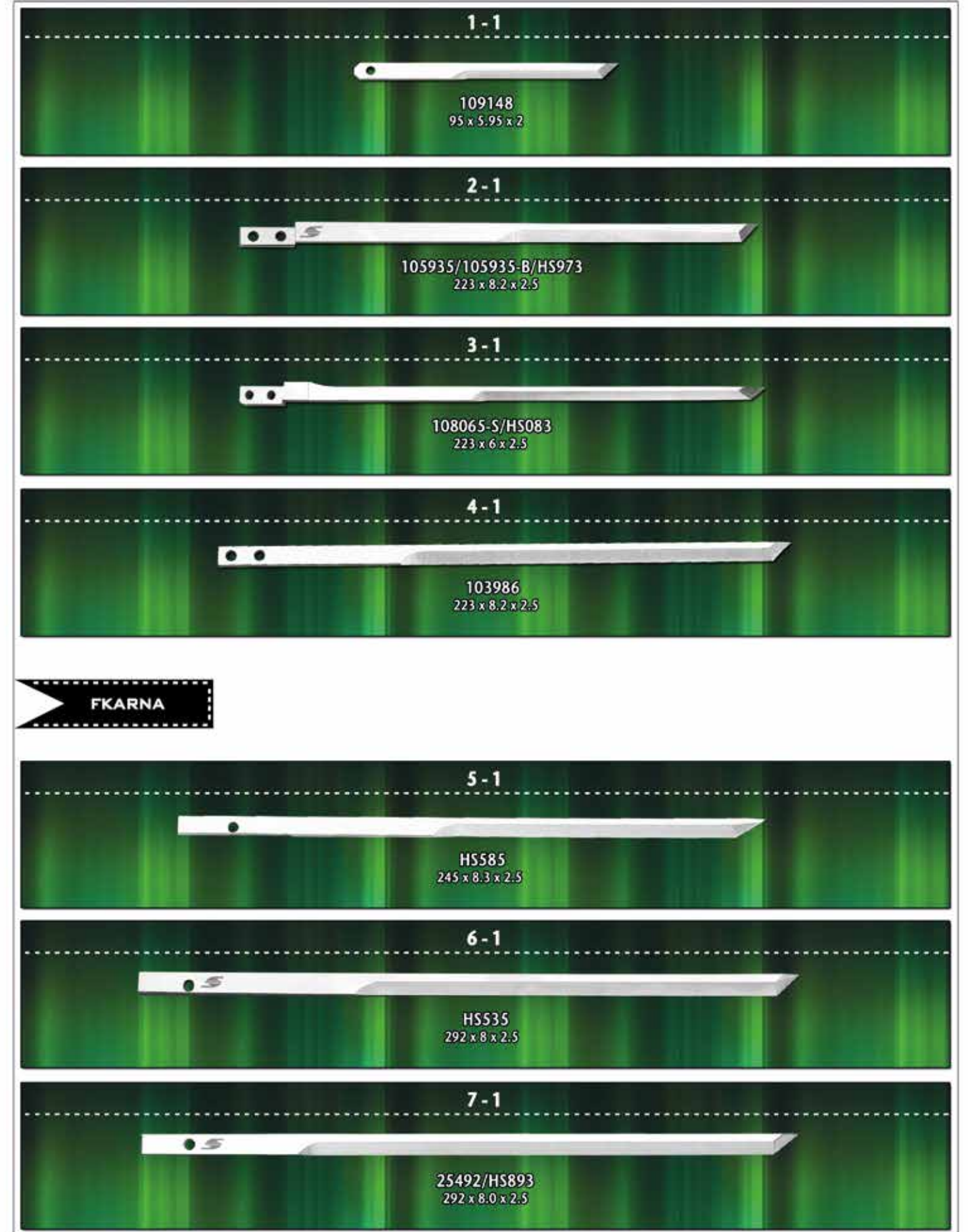
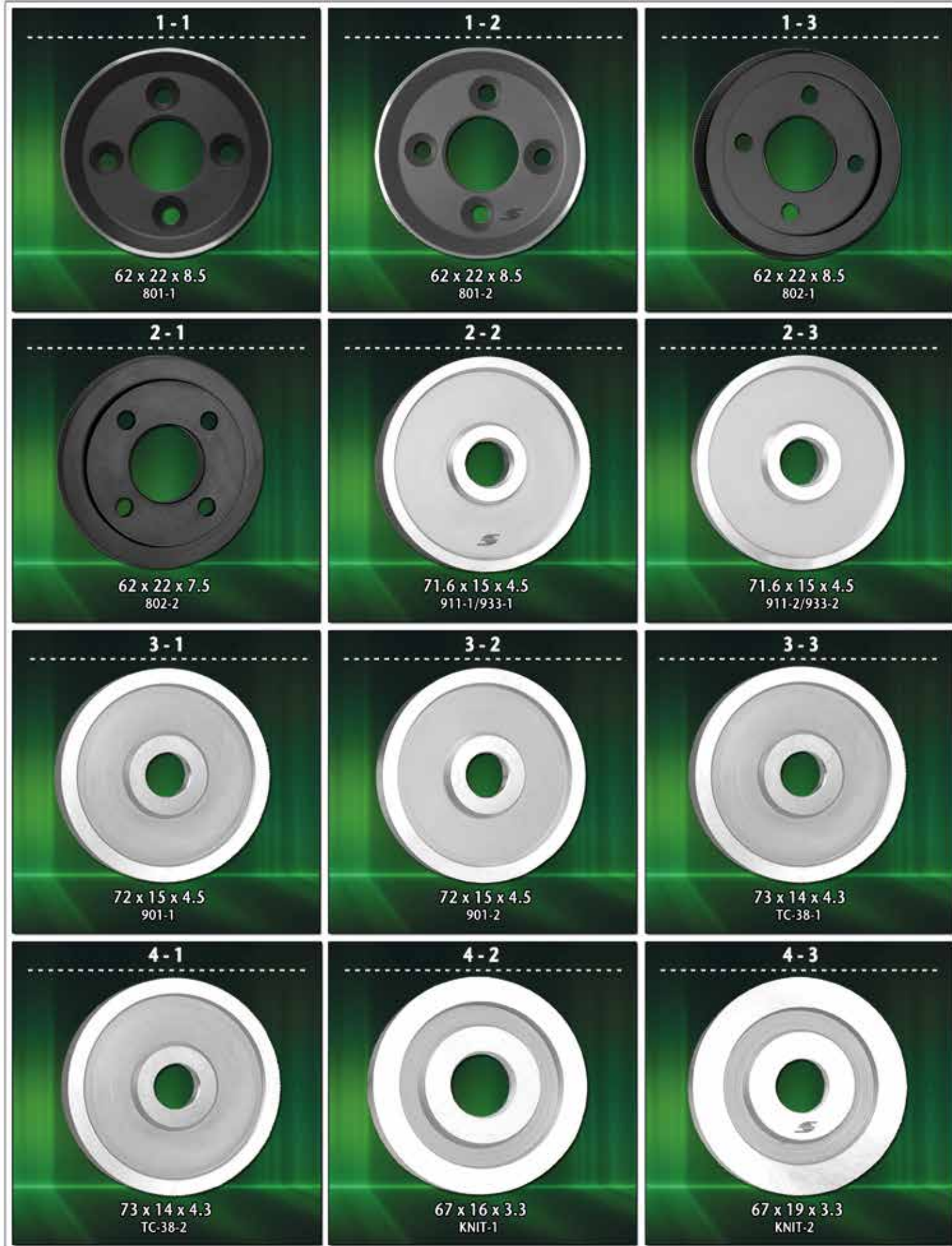



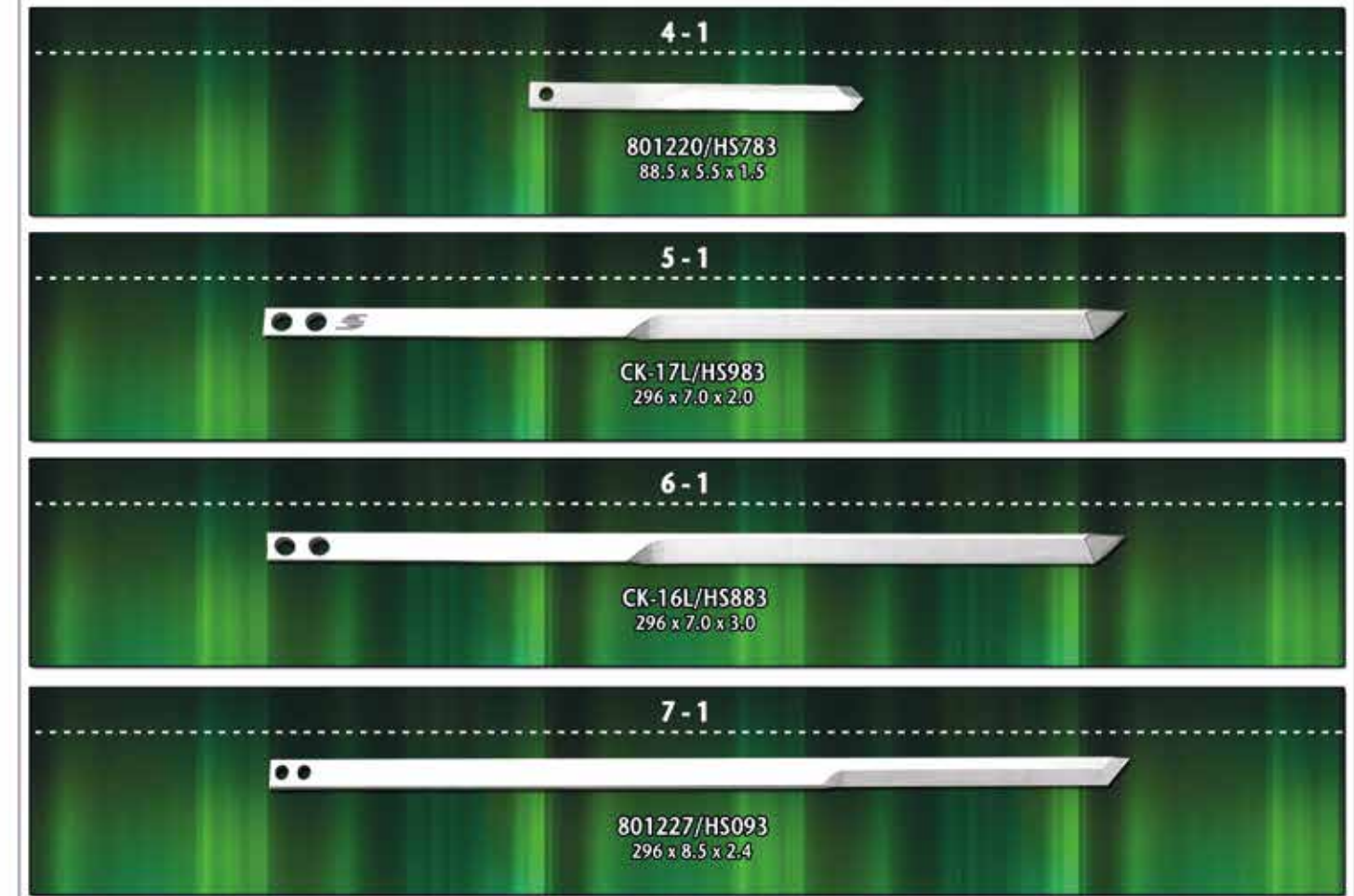
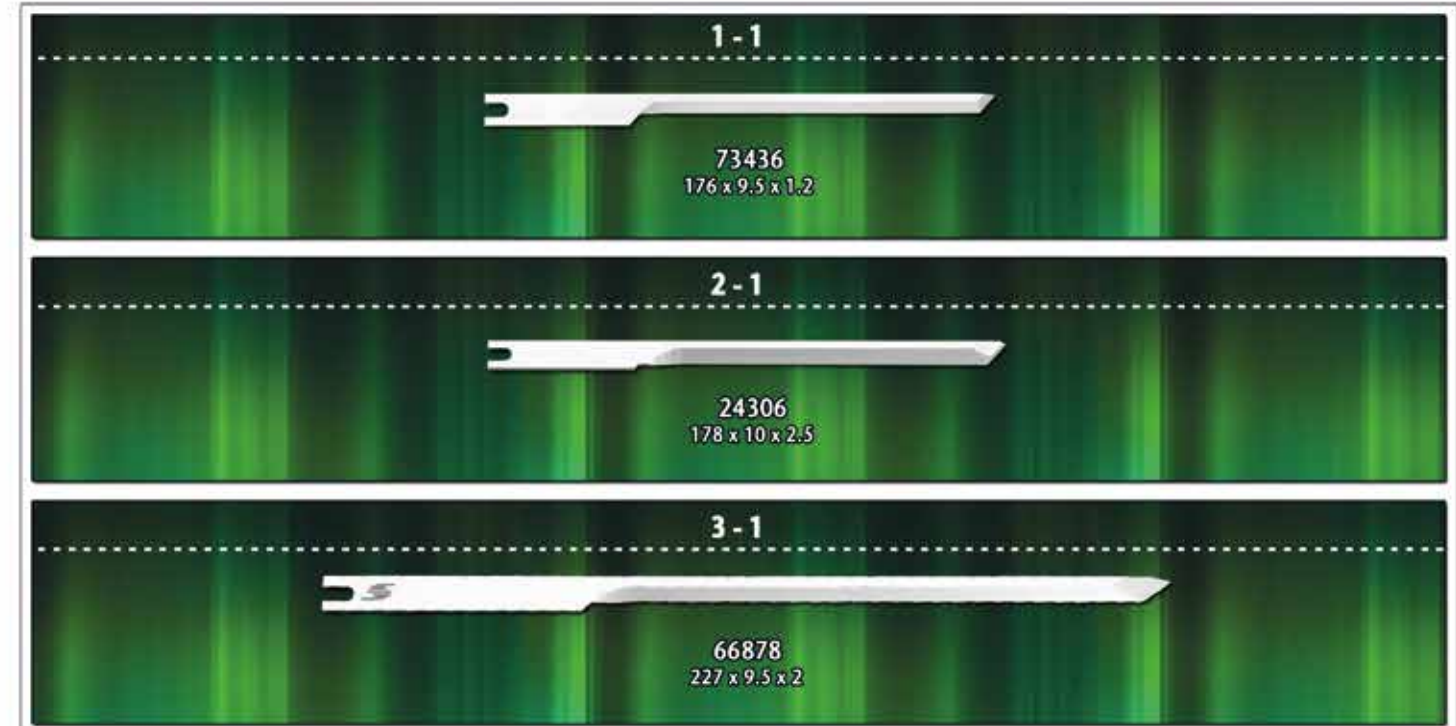
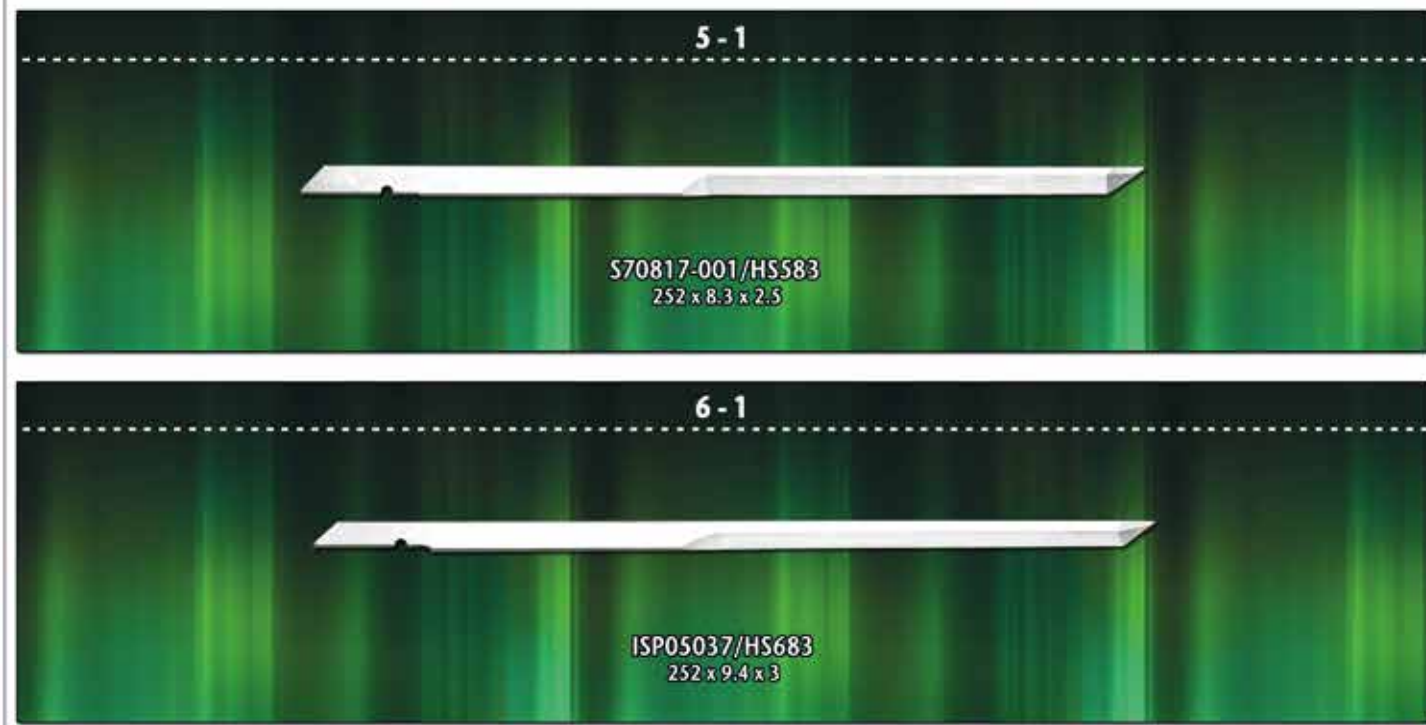
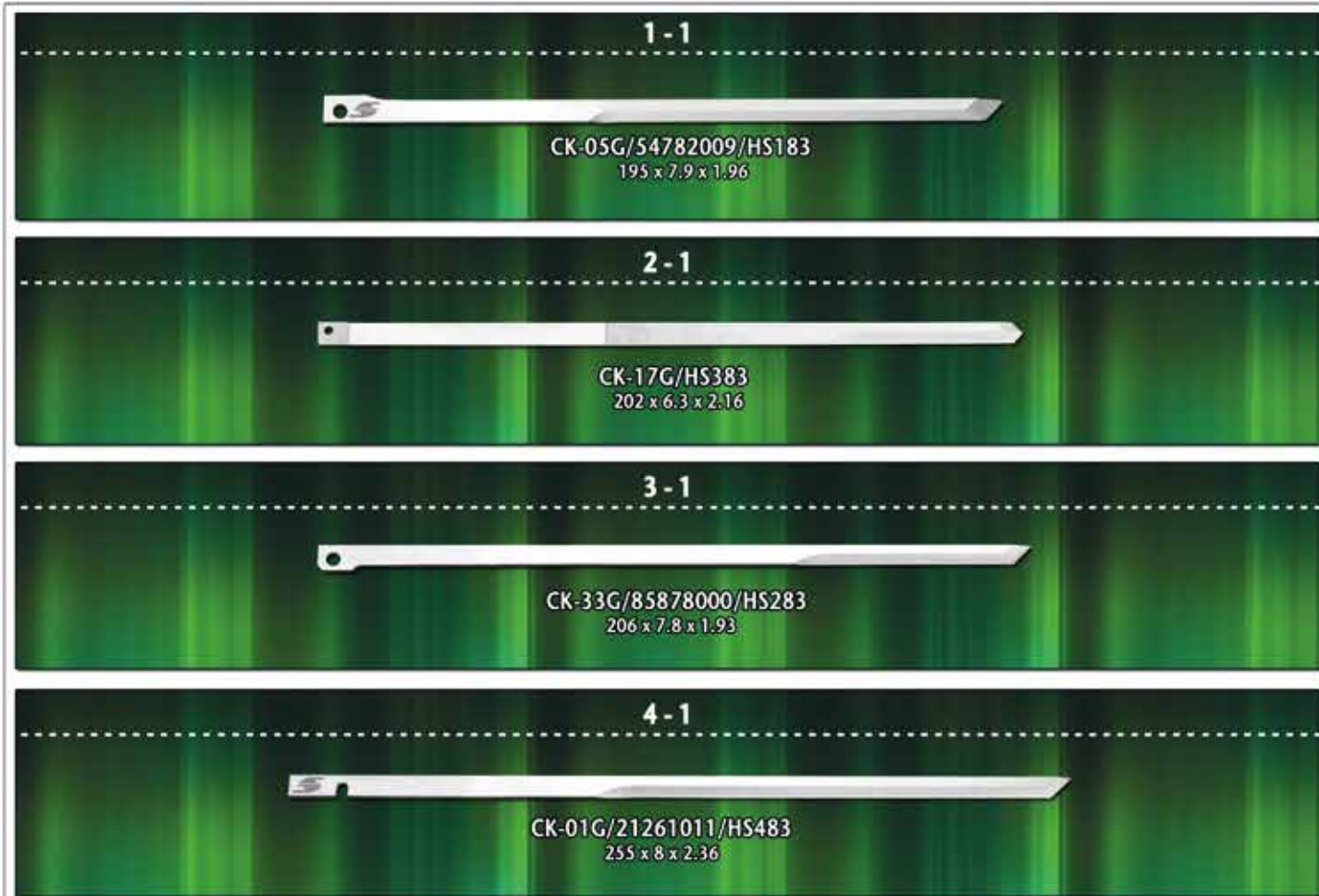



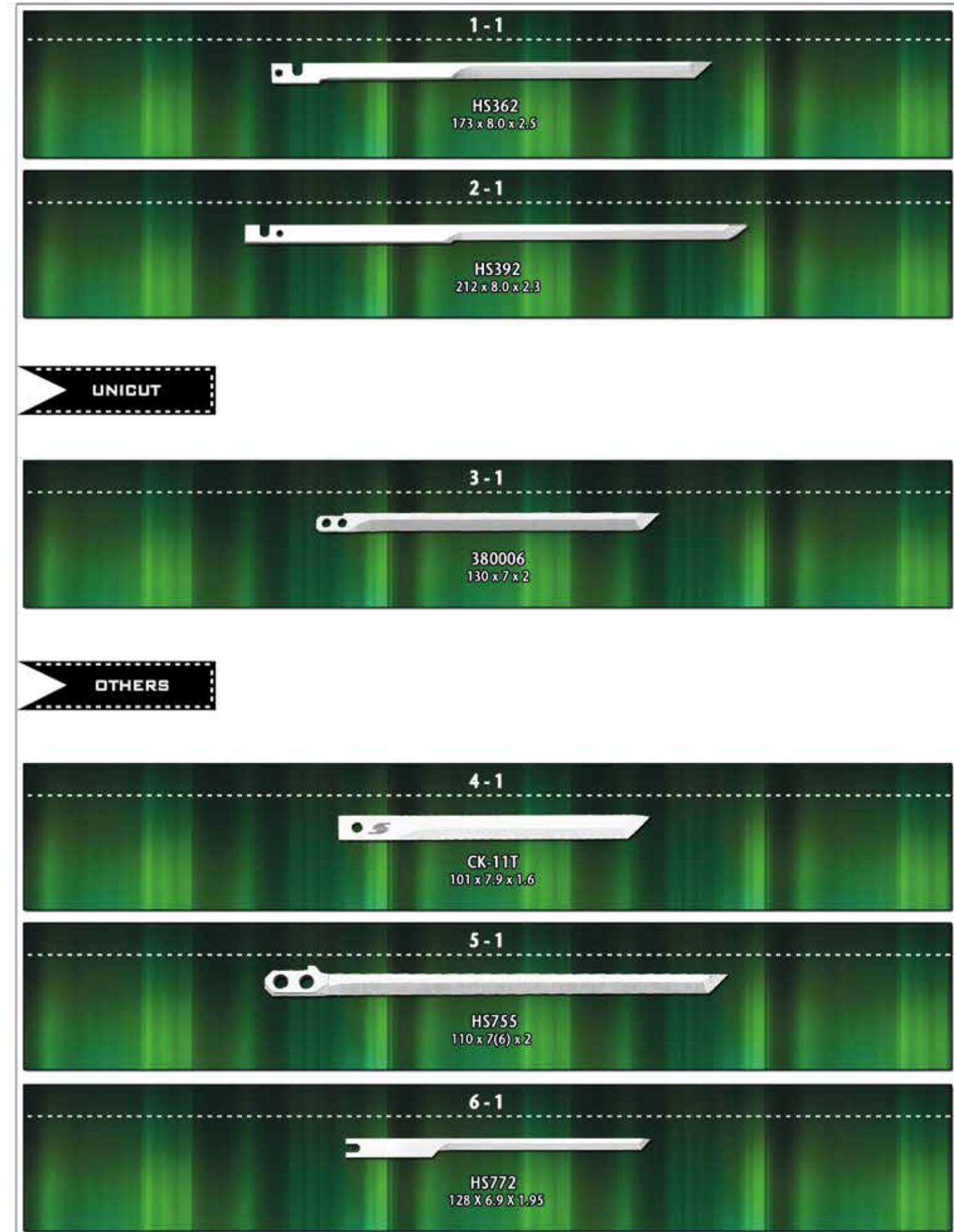
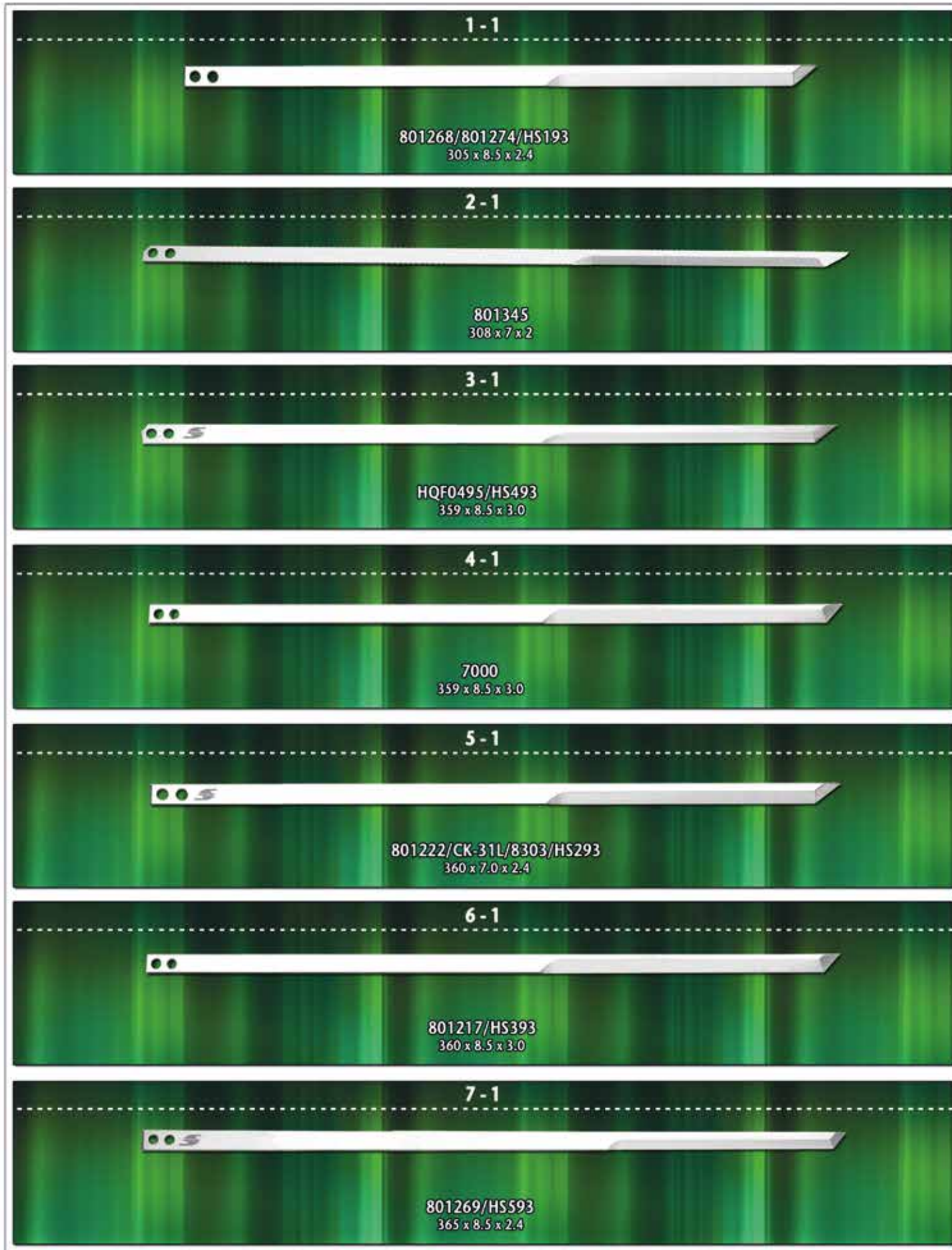



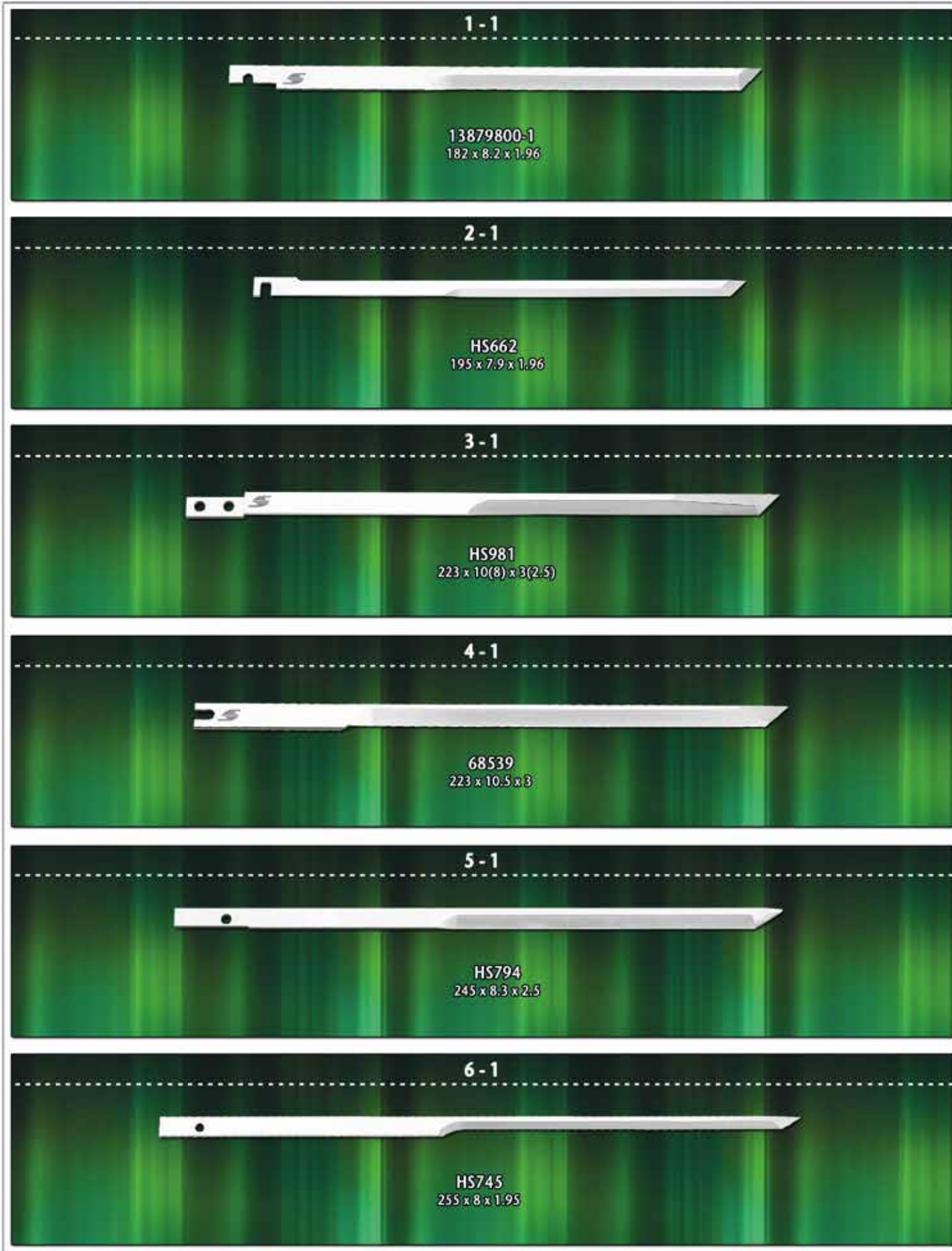



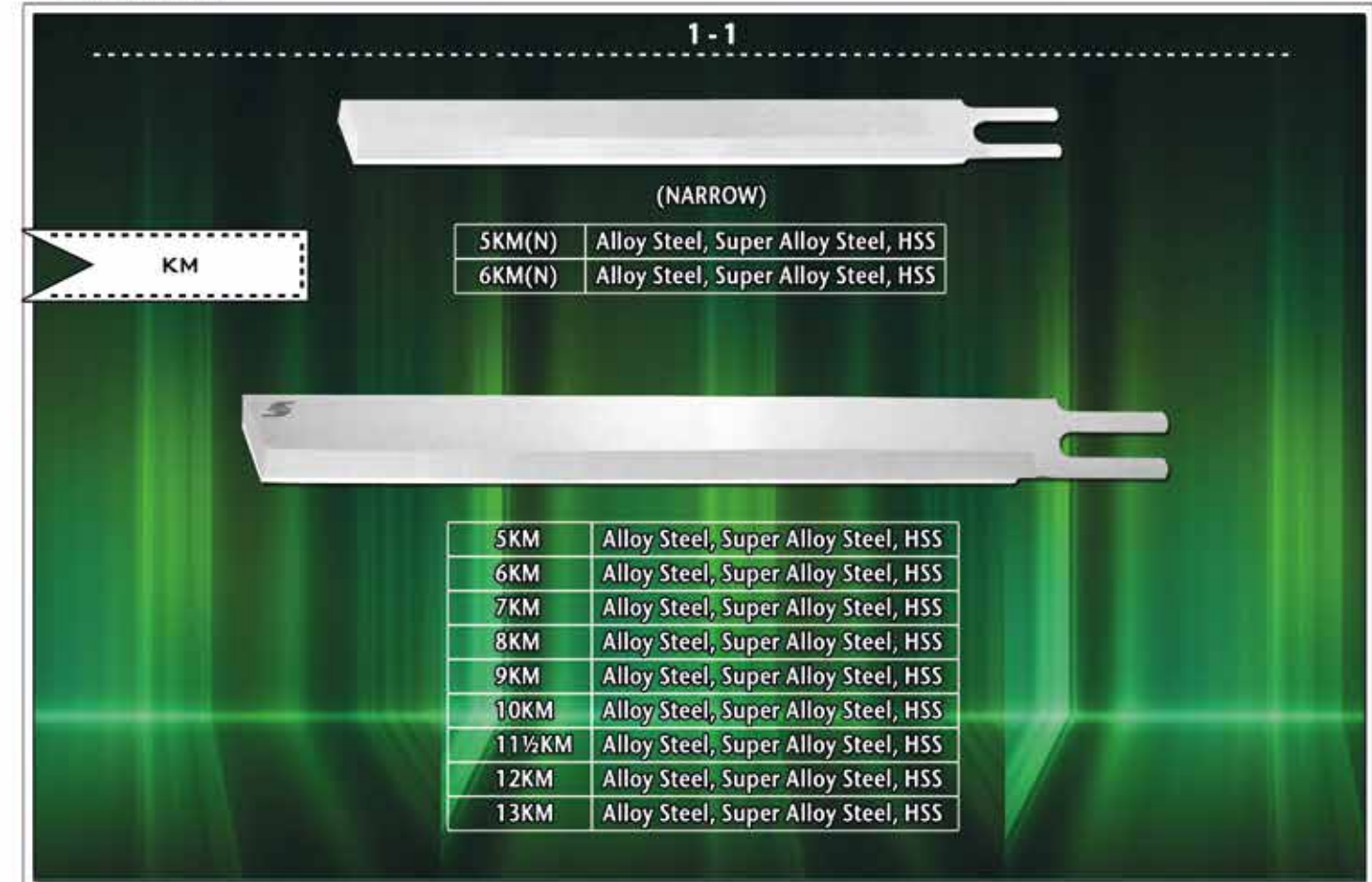
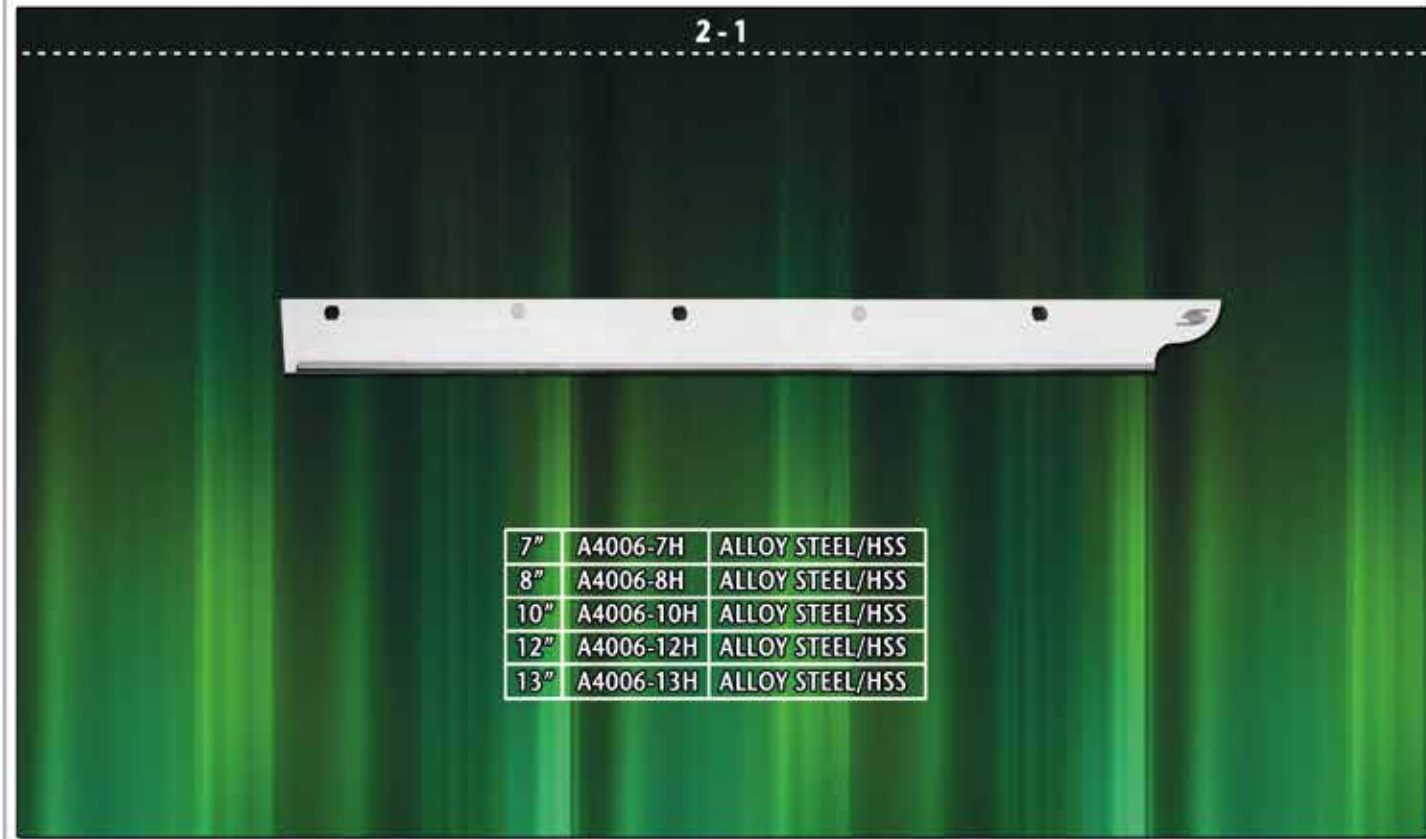
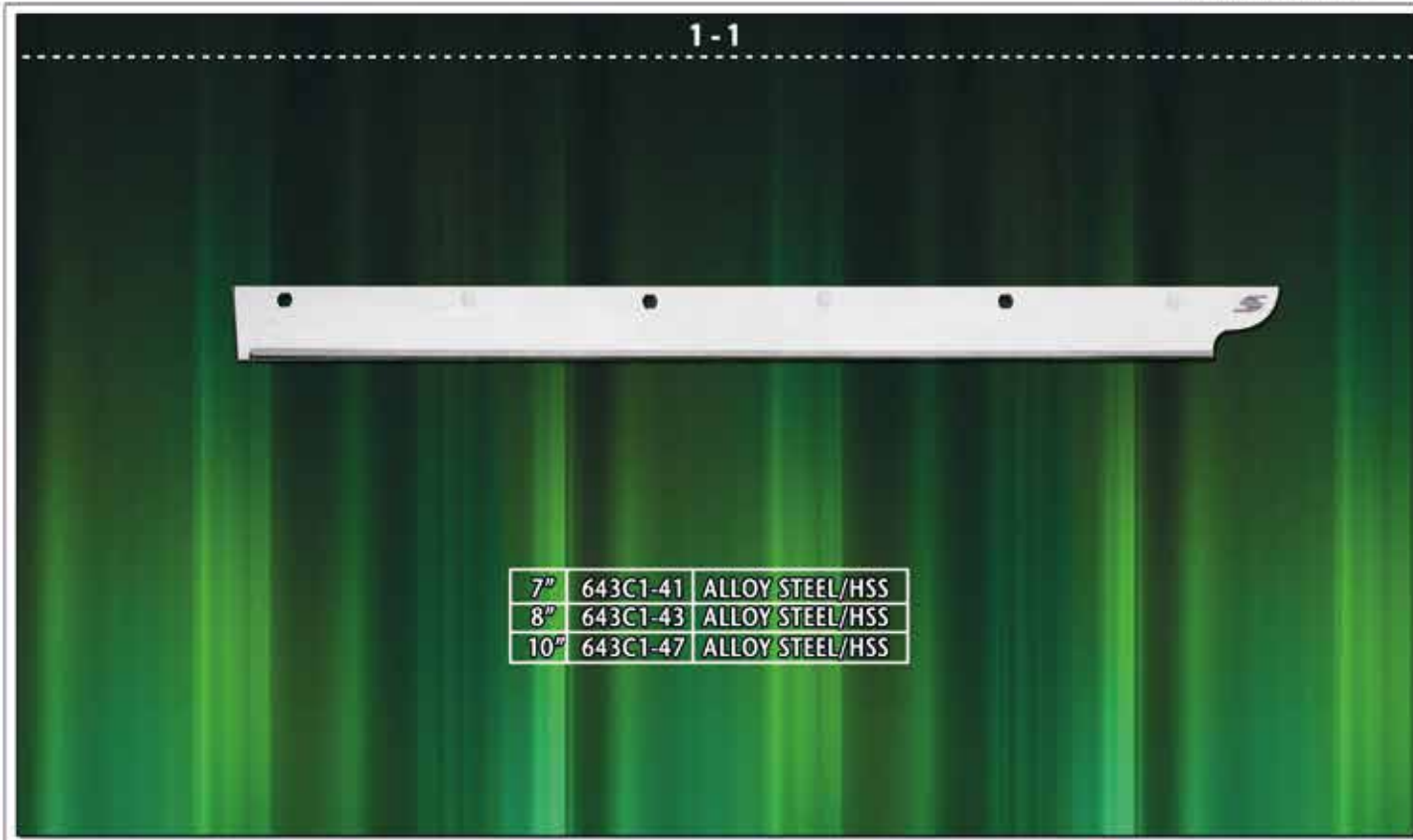





FOR CUTTING MACHINES

**1-1**

5KMW(N)	Alloy Steel, Super Alloy Steel, HSS
6KMW(N)	Alloy Steel, Super Alloy Steel, HSS

6KMW	Alloy Steel, Super Alloy Steel, HSS
7KMW	Alloy Steel, Super Alloy Steel, HSS
8KMW	Alloy Steel, Super Alloy Steel, HSS
9KMW	Alloy Steel, Super Alloy Steel, HSS
10KMW	Alloy Steel, Super Alloy Steel, HSS

**2-1**

5EW	Alloy Steel, Super Alloy Steel, HSS
6EW	Alloy Steel, Super Alloy Steel, HSS
7EW	Alloy Steel, Super Alloy Steel, HSS
8EW	Alloy Steel, Super Alloy Steel, HSS
9EW	Alloy Steel, Super Alloy Steel, HSS
10EW	Alloy Steel, Super Alloy Steel, HSS
13EW	Alloy Steel, Super Alloy Steel, HSS

**EASTMAN**

6EW(KO)	Alloy Steel, Super Alloy Steel, HSS
7EW(KO)	Alloy Steel, Super Alloy Steel, HSS
8EW(KO)	Alloy Steel, Super Alloy Steel, HSS
9EW(KO)	Alloy Steel, Super Alloy Steel, HSS
10EW(KO)	Alloy Steel, Super Alloy Steel, HSS

DEEP WAVE



FOR CUTTING MACHINES

<b>1-1</b>  820C1-7	<b>1-2</b>  820C1-8	<b>1-3</b>  743C1-29	<b>1-4</b>  743C1-28
<b>2-1</b>  579C2-17	<b>2-2</b>  24C1-3	<b>2-3</b>  525C1-5-1	<b>2-4</b>  525C1-5-2



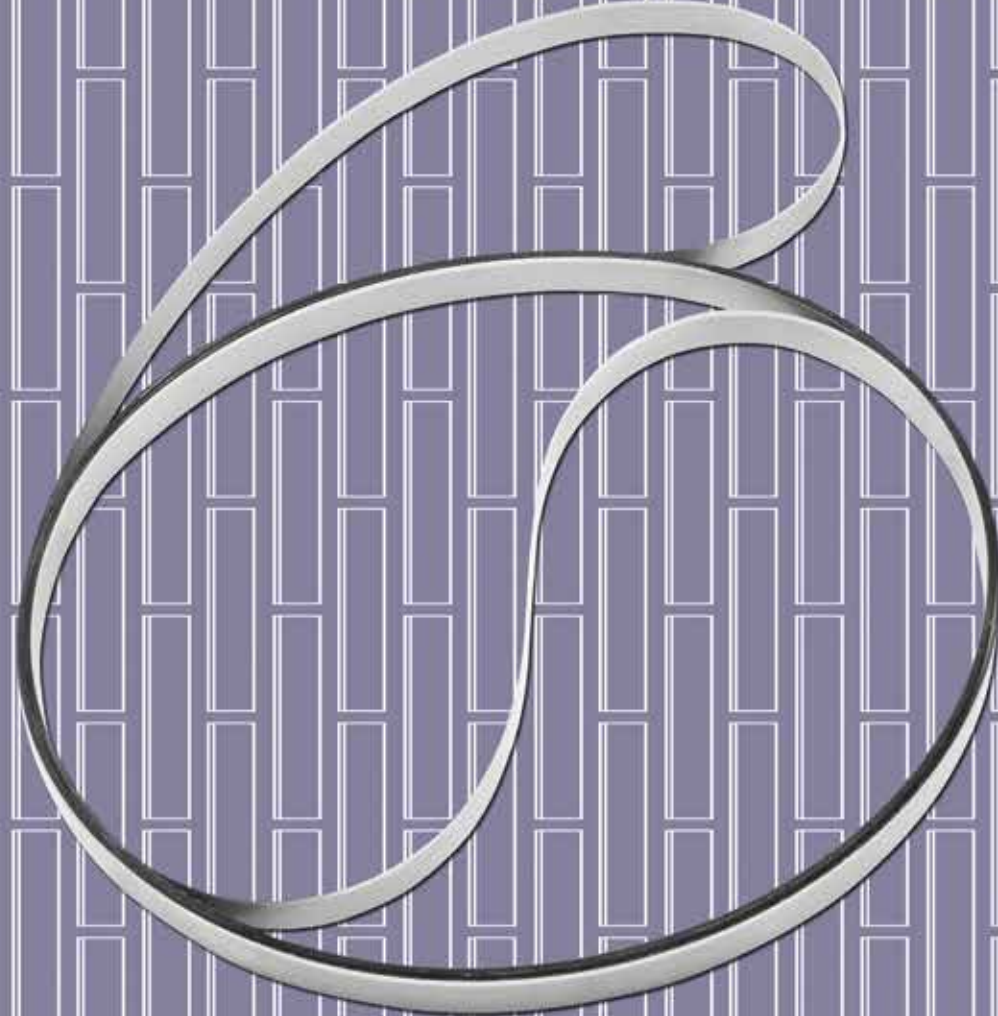

SIZE

2450 x 10 x 0.45	3760 x 10 x 0.45	4450 x 10 x 0.45
2800 x 10 x 0.45	3850 x 10 x 0.45	4500 x 10 x 0.45
3000 x 10 x 0.45	3860 x 10 x 0.45	4550 x 10 x 0.45
3100 x 10 x 0.45	3900 x 10 x 0.45	4555 x 10 x 0.45
3150 x 10 x 0.45	3960 x 10 x 0.45	4560 x 10 x 0.45
3200 x 10 x 0.45	4000 x 10 x 0.45	4700 x 10 x 0.45
3500 x 10 x 0.45	4100 x 10 x 0.45	4900 x 10 x 0.45
3600 x 10 x 0.45	4120 x 10 x 0.45	4920 x 10 x 0.45
3700 x 10 x 0.45	4200 x 10 x 0.45	5200 x 10 x 0.45

10mm, 15 mm ve 20 mm kalınlığında talep edilen tüm ölçülerde Hızır Bıçağı üretimi  
(Band Knife Production with all requested sizes of 10 mm, 15mm and 20 mm thickness)

SANAYİ KONFEKSİYON  
DİKİŞ MAKİNALARI **PLAKALARI**

**NEEDLE PLATE ASSEMBLY** FOR INDUSTRIAL  
SEWING MACHINES



**KL3-B430  
ASSEMBLY FOR LK3-B430**

NO.	PART NO.	REMARKS
1	S18426-001	match 4-1/4-2/4-3
2	S15295-001	
3	100360-003	
4-1	S156150-001	φ=1.8
4-2	S156151-001	φ=2.2
4-3	S156152-001	φ=2.5
5	S152905-001	
6	111140-002	
7	S152897-201	
8	S153220-001	
9	S152901-001	
10	S153219-001	
11	S152904-001	
12	S152981-001	
13	S153222-001	
14	S152906-101	
15	S153597-001	
16	S153596-001	
17	081008-070	
18	S153598-001	

Remark: Can be matched needle plate size  
φ 1.8, φ 2.5, φ 2.6, φ 2.8.

**HS-034D  
ASSEMBLY FOR HS-034D**

NO.	PART NO.	REMARKS
1-1	HS-034D (Light)	match 3-1/5-1/10-1
1-2	HS-034D (Medium)	match 3-2/5-1/10-1
1-3	HS-034D (Heavy)	match 3-3/5-2/10-2
2	SA3655-001	
3-1	SA3652-201	φ=1.6
3-2	SA3653-201	φ=2.2
3-3	SA3336-001	φ=2.4
4	100360-003	
5-1	SA6597-001	
5-2	SA6431-001	
6	025030-236	
7	028030-246	
8	062300-416	
9-1	SA6397-001	t=0.2
9-2	SA3334-001	t=0.3
9-3	SA6398-001	t=0.4
10-1	SA6596-001	
10-2	SA6429-001	
11	S00705-001	
12	SA4519-001	
13	SA4518-001	
14	SA3343-001	
15	025030-236	
16	062300-416	
17	SA3344-001	
18	SA3341-001	
19	SA3342-001	
20	SA3337-001	
21	SA4330-001	
22	SA4329-001	
23	SA3333-001	

Remark: Can be matched needle plate size  
φ 1.8, φ 2.5, φ 2.6, φ 2.8.

**HS-034E  
ASSEMBLY FOR HS-034E**

NO.	PART NO.	REMARKS
1	HS-034E	
2	S38015001	
3	100360003	
4	S10213101	
5	S10210201	
6	111140002	
7	S38016001	
8	S10208005	
9	S00705001	
10	S49988001	
11	S10209101	

**BE-438D  
ASSEMBLY FOR BE-438D**

NO.	PART NO.	REMARKS
1	BE-438D (Light)	
2	SA3655-001	
3	SA3654-201	φ=1.6
4	100360-003	
5-1	SA6431-001	
5-2	SA6597-001	
6	025030-236	
7	028030-246	
8	062300-416	
9-1	SA6397-001	t=0.2
9-2	SA3334-001	t=0.3
9-3	SA6398-001	t=0.4
10-1	SA6596-001	
10-2	SA6429-001	
11	S00705-001	
12	SA4519-001	
13	SA4518-001	
14	SA3343-001	
15	025030-236	
16	062300-416	
17	SA3344-001	
18	SA3341-001	
19	SA3342-001	
20	SA3337-001	
21	SA4330-001	
22	SA4329-001	
23	SA3333-001	



**ZE-8560A  
ASSEMBLY FOR ZE-8560A**

NO.	PART NO.	REMARKS
1-1	S48236-201	match 7-1
1-2	S58941-201	match 7-2
2	SA8458-001	
3	S55865-001	
4	S48246-001	
5	155103-001	
6	SA8459-001	
7-1	S55863-001	
7-2	S58943-001	
8	100105005	
9	S48239-001	
10	S48238-101	
11	062670-712	
12	S48240-001	
13	S48247-001	

**LK-1900  
ASSEMBLY FOR LK-1900**

NO.	PART NO.	REMARKS
1	LK-1900	match 4-1/4-2/4-3
2	135-15507	
3	SS-1060210-TP	
4-1	B2426-280-000	φ = 1.6
4-2	B2426-280-00B	φ = 2.0
4-3	B2426-280-00C	φ = 2.3
5	B2416-280-000	
6	B2424-280-000	
7	SS-7090410-SP	
8	B2415-280-0A0	
9-1	B2423-280-00A	t = 0.4
9-2	B2423-280-00B	t = 0.5
9-3	B2423-280-00C	t = 0.6
9-4	B2423-280-00D	t = 0.7
9-5	B2423-280-00E	t = 0.8
10	B2418-280-000	
11	B2421-280-0A0	
12	SD-0500091-TP	
13	B2414-280-0A0	
14	WP-0450846-SP	
15	SS-7110740-TP	
16	SS-6110430-TP	
17	B2417-280-000	

Remark: Can be matched needle plate size  
φ 1.6, φ 1.8, φ 2.0, φ 2.3,  
φ 2.4, φ 2.6, φ 2.8, φ 3.0.

**JUKI**

**LK-1850  
ASSEMBLY FOR LK-1850**

NO.	PART NO.	REMARKS
1	LK-1850	match 4-1/4-2/4-3
2	135-15564	
3	SS-1060210-TP	
4-1	B2426-280-000	φ = 1.6
4-2	B2426-280-00B	φ = 2.0
4-3	B2426-280-00C	φ = 2.3
5	B2416-280-000	
6	B2424-280-000	
7	SS-7090410-SP	
8	B2415-280-0A0	
9-1	B2423-280-00A	t = 0.4
9-2	B2423-280-00B	t = 0.5
9-3	B2423-280-00C	t = 0.6
9-4	B2423-280-00D	t = 0.7
9-5	B2423-280-00E	t = 0.8
10	B2418-280-000	
11	B2421-280-0A0	
12	SD-0500091-TP	
13	B2414-280-0A0	
14	WP-0450846-SP	
15	SS-7110740-TP	
16	SS-6110430-TP	
17	B2417-280-000	

Remark: Can be matched needle plate size  
φ 1.6, φ 1.8, φ 2.0, φ 2.3,  
φ 2.4, φ 2.6, φ 2.8, φ 3.0.

**LK-1900A  
ASSEMBLY FOR LK-1900A**

NO.	PART NO.	REMARKS
1	LK-1900A	
2	400-06721	
3	SS-1060210-TP	
4-1	D2426-282-C00	φ = 1.6
4-2	B2426-280-00B	φ = 2.0
4-3	B2426-280-00C	φ = 2.3
5	B2416-280-000	
6	B2424-280-000	
7	SS-7090410-SP	
8	B2415-280-0A0	
9-1	B2423-280-00A	t = 0.4
9-2	B2423-280-00B	t = 0.5
9-3	B2423-280-00C	t = 0.6
9-4	B2423-280-00D	t = 0.7
9-5	B2423-280-00E	t = 0.8
10	B2418-280-000	
11	B2421-280-0A0	
12	SD-0500091-TP	
13	B2414-280-0A0	
14	WP-0450846-SP	
15	SS-7110740-TP	
16	SS-6110430-TP	
17	B2417-280-000	

Remark: Can be matched needle plate size  
φ 1.6, φ 2.0, φ 2.3, φ 2.4, φ 2.6 φ 2.8



**LK-1903A  
ASSEMBLY FOR LK-1903A**

NO.	PART NO.	REMARKS
1 - 1	400-06725	
1 - 2	400-06726	
2	400-06721	
3	SS-1060210-TP	
4 - 1	MAZ-15801000	$\phi = 1.6$
4 - 2	MAZ-15601000	$\phi = 2.0$
5	B2416-280-000	
6	B2424-280-000	
7	SS-7090410-SP	
8	B2415-280-0A0	
9 - 1	B2423-280-00A	t = 0.4
9 - 2	B2423-280-00B	t = 0.5
9 - 3	B2423-280-00C	t = 0.6
9 - 4	B2423-280-00D	t = 0.7
9 - 5	B2423-280-00E	t = 0.8
10	B2418-280-000	
11	B2421-280-0A0	
12	SD-0500091-TP	
13	B2414-280-0A0	
14	WP-0450846-SP	
15	SS-7110740-TP	
16	SS-6110430-TP	
17	B2417-280-000	

Remark: Can be matched needle plate size  $\phi 1.6, \phi 2.0$ .

**LK-1910/1920  
ASSEMBLY FOR LK-1910/1920**

NO.	PART NO.	REMARKS
1	LK1910/LK1920	match 4-1/4-2
2	142-13003	
3	SS-1060210-TP	
4 - 1	D2426-284-M00	$\phi = 1.6$
4 - 2	141-09607	$\phi = 2.0$
5	B2424-280-000	$\phi = 2.3$
6	SS-7090410-SP	
7	B2418-280-000	
8-1	B2423-280-00A	t = 0.4
8-2	B2423-280-00B	t = 0.5
8-3	B2423-280-00C	t = 0.6
8-4	B2423-280-00D	t = 0.7
8-5	B2423-280-00E	t = 0.8
9	B2421-280-0A0	
10	SD-0500091-TP	
11	B2417-280-000	
12	B2416-280-000	
13	B2416-210-DA0	
14	B2414-280-000	
15	SS-6110430-TP	
16	WP-0450846-SP	
17	SS-7110740-TP	

Remark: Can be matched needle plate size  $\phi 1.6, \phi 1.8, \phi 2.0, \phi 2.3, \phi 2.4$ .

**AMS-210D  
ASSEMBLY FOR AMS-210D**

NO.	PART NO.	REMARKS
1-1	B2425-210-DAA	
1-2	B2425-210-DAB	
2	B2425-210-000	
3	SS-1060210-TP	
4-1	B2426-210-00A	$\phi = 1.6$
4-2	B2426-210-00B	$\phi = 2.0$
5	B2424-210-000	
6	SS-7090410-SP	
7	B2418-280-000	
8-1	B2423-280-00A	t = 0.4
8-2	B2423-280-00B	t = 0.5
8-3	B2423-280-00C	t = 0.6
8-4	B2423-280-00D	t = 0.7
9	B2421-210-AA0	
10	B2417-210-000	
11	B2417-280-000	
12	B2416-280-000	
13	B2416-210-0A0	
14	B2414-280-0A0	
15	SS-6110430-TP	
16	WP-0450846-SP	
17	SS-7110740-TP	

Remark: Can be matched needle plate size  $\phi 1.6, \phi 2.0, \phi 2.8, \phi 3.0$ .

**AMS-215D  
ASSEMBLY FOR AMS-215D**

NO.	PART NO.	REMARKS
1-1	B2425-221-DAA	
1-2	B2425-221-DAB	
2	B2425-215-P00	
3	SS-1060210-TP	
4-1	B2426-210-00A	$\phi = 1.6$
4-2	B2426-210-00B	$\phi = 2.0$
5	B2424-210-000	
6	SS-7090410-SP	
7	B2418-280-000	
8-1	B2423-280-00A	t = 0.4
8-2	B2423-280-00B	t = 0.5
8-3	B2423-280-00C	t = 0.6
8-4	B2423-280-00D	t = 0.7
9	B2421-210-AA0	
10	B2417-210-000	
11	B2417-280-000	
12	B2416-280-000	
13	B2416-210-0A0	
14	B2414-280-0A0	
15	SS-6110430-TP	
16	WP-0450846-SP	
17	SS-7110740-TP	



**AMS-210E  
ASSEMBLY FOR AMS-210E**

NO.	PART NO.	REMARKS
1-1	40030932	
1-2	40030933	
2	40030934	
3	SS-1060210-TP	
4-1	B2426-210-00A	φ = 1.6
4-2	B2426-210-00B	φ = 2.0
5	B2424-210-000	
6	SS-7090410-SP	
7	B2418-280-000	
8-1	B2423-280-00A	t = 0.4
8-2	B2423-280-00B	t = 0.5
8-3	B2423-280-00C	t = 0.6
8-4	B2423-280-00D	t = 0.7
9	B2421-210-AA0	
10	B2417-210-000	
11	B2417-280-000	
12	B2416-280-000	
13	B2416-210-0A0	
14	B2414-280-0A0	
15	SS-6110430-TP	
16	WP-0450846-SP	
17	SS-7110740-TP	

Remark: Can be matched needle size  
φ 1.6, φ 2.0, φ 3.0.

**MB-373  
ASSEMBLY FOR MB-373**

NO.	PART NO.	REMARKS
1	B1241-373-0B0	
2	B1241-373-000	
3	B2406-373-0A0	
4	SD-0600095-TH	
5	B2410-373-000	
6	SS-7080310-SP	

**MB-377  
ASSEMBLY FOR MB-377**

NO.	PART NO.	REMARKS
1	B1241-377-0B0	
2	B1241-377-000	
3	B2406-373-0A0	
4	SD-0600095-TH	
5	B2702-377-000	
6	B2410-373-000	
7	SS-7080310-SP	
8	B2703-377-0A0	

**LBH-780  
ASSEMBLY FOR LBH-780**

NO.	PART NO.	REMARKS
1	B2401-771-0A0	
2	B2401-771-0B0	
3	SS-2090510-SP	
4	B2402-771-000	
5	B2405-771-000	
6	B2408-771-000-A	
7	SS-4080310-SP	
8	WP-0451016-SP	
9	SS-7110570-SP	
10	B2404-771-000	
11	B2406-771-0A0	
12	SS-5090320-SP	
13	SS-6090440-SP	
14	B2001-771-0A0	



**LBH-780  
ASSEMBLY FOR LBH-780**

NO.	PART NO.	REMARKS
1	B2401-771-0A0-0	
2	B2401-771-0B0	
3	SS-2090510-SP	
4	B2402-771-000	
5	B2405-771-000	
6	B2408-771-000-A	
7	SS-4080310-SP	
8	WP-0451016-SP	
9	SS-7110570-SP	
10	B2404-771-000	
11	B2406-771-0A0	
12	SS-5090320-SP	
13	SS-6090440-SP	
14	B1807-771-000	
15	SS-7110510-SP	
16	B2420-771-000	
17	SD-0640321-SP	
18	B2425-771-000	
19	SS-6110610-TP	
20	B2426-771-000	
21	SD-0630272-SP	
22	B2429-771-000	
23	NS-6120310-SP	
24	B2427-771-000	
25	B2428-771-000	
26	B2001-771-0A0	

**LZ-2290  
ASSEMBLY FOR LZ-2290**

NO.	PART NO.	REMARKS
1	225-57458	
2	225-58308	
3	225-58407	
4	NP-2103000-00	
5	225-58209	
6	225-57904	
7	225-57805	
8	SS-7090610-SP	
9	SS-1090510-SP	
10	D2056-772-B0B	
11	225-58100	
12	WS-027002-KN	
13	SS-7060310-SP	
14	225-58001	
15	225-57706	
16	225-57557	

**PLK-1006  
ASSEMBLY FOR PLK-1006**

NO.	PART NO.	REMARKS
1	PLK1006	
2	MS0TA0472	
3	MS0TA1476	
4	MS03A1-101	φ = 3.0
5	M90605010	
6	MA10B2476	
7	MS03A0838	
8	M90906003	
9	M91129015	
10	M9600A052	
11	MS03B0838	

**SUNSTAR**

**SPA/A-1306-HS  
ASSEMBLY FOR SPA/A-1306-HS**

NO.	PART NO.	REMARKS
1	1306	
2	10S040S-306H	
3	040075C-5030	
4	10S042S-306H	
5-1	10-054W-120H	t=0.5
5-2	10-051W-120H	t=0.6
5-3	10-052W-120H	t=0.7
6	10S047S-306H	
7	10S048S-306H	
8	10S045S-306H	
9	10S046S-306H	
10	10S053S-306H	
11	10S057S-306H	
12	GD-036239-00	
13	10S058S-306H	
14	10S050S-306H	
15	10S060S-306H	
16	10S059S-306H	
17	10S056S-306H	

Remark: Can be matched needle plate size  
φ 1.6, φ 2.0.





HS-034D  
SHUTTLE RACE ASSEMBLY FOR HS-034D

NO.	PART NO.	REMARKS
1	SA3239-201	
2	SA3284-201	
3-1	152682-201	Medium Materials
3-2	152686-201	Heavy Materials



HS-034F  
SHUTTLE RACE ASSEMBLY FOR HS-034F

NO.	PART NO.	REMARKS
1	SB1072-001	
2	SA6448-301	
3-1	152682-201	Medium Materials
3-2	152686-201	Heavy Materials



BAS-311G  
SHUTTLE RACE ASSEMBLY FOR BAS-311G

NO.	PART NO.	REMARKS
1	SA6220-101	
2	SA6448-301	
3-1	152682-201	Medium Materials
3-2	152686-201	Heavy Materials

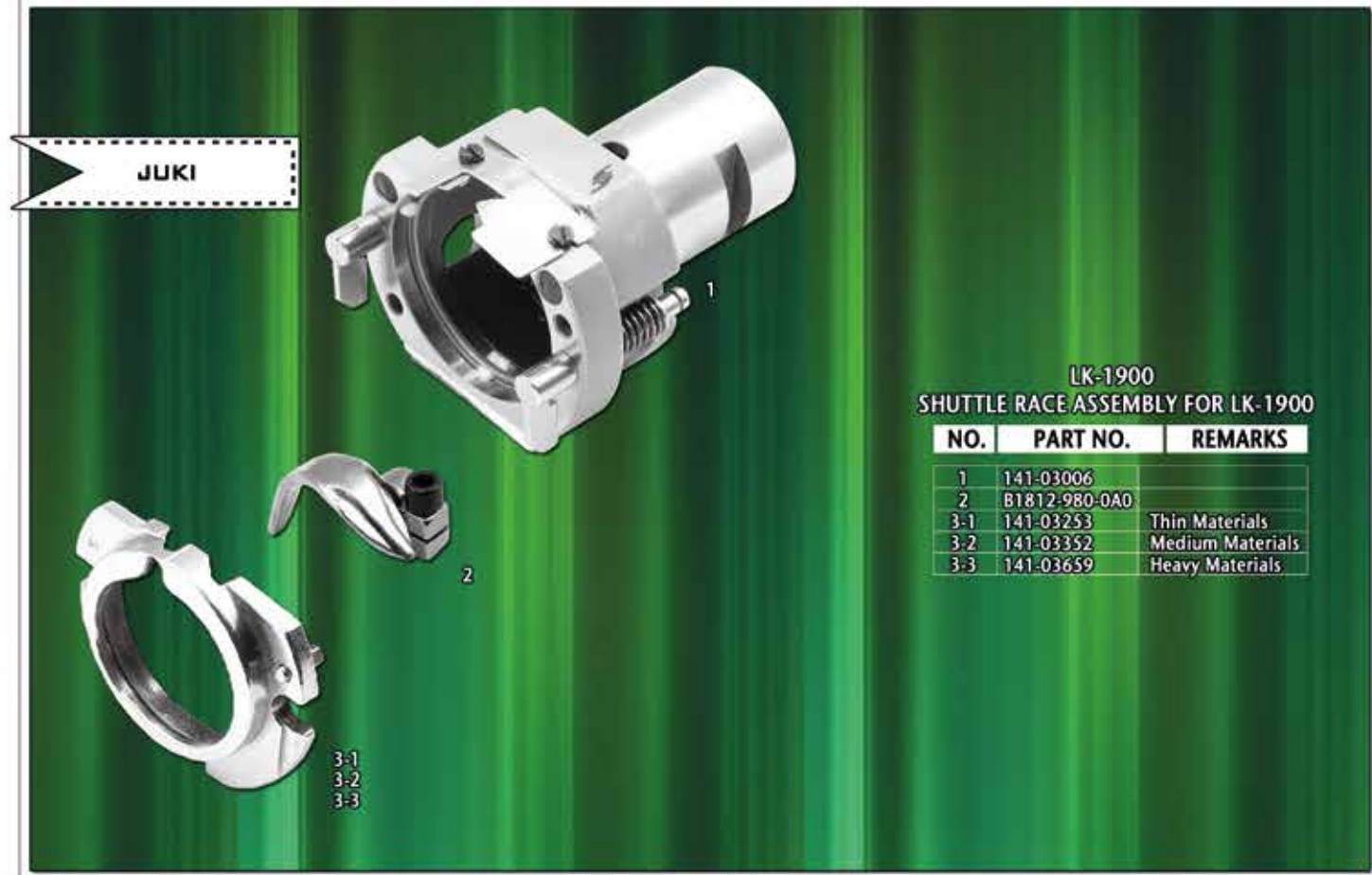

LK-1900  
SHUTTLE RACE ASSEMBLY FOR LK-1900

NO.	PART NO.	REMARKS
1	141-03006	
2	B1812-980-0A0	
3-1	141-03253	Thin Materials
3-2	141-03352	Medium Materials
3-3	141-03659	Heavy Materials





LK-1900A  
SHUTTLE RACE ASSEMBLY FOR LK-1900A

NO.	PART NO.	REMARKS
1	400-06574	
2-1	400-11512	
2-2	400-14963	
3-1	141-03253	Thin Materials
3-2	141-03352	Medium Materials
3-3	141-03659	Heavy Materials



AMS-210D  
SHUTTLE RACE ASSEMBLY FOR AMS-210D

NO.	PART NO.	REMARKS
1	81842-210-D00	
2	81812-210-D00	
3	81817-210-DAB	

# SANAYİ KONFEKSİYON DİKİŞ MAKİNALARI

PLAKALARI  
PLAKALARI  
AYAKLARI  
İĞNE BAĞLARI  
İĞNE SİPERLERİ

NEEDLE PLATE  
FEED DOG  
PRESSER FOOT  
NEEDLE CLAMP  
NEEDLE GUARD

# FOR INDUSTRIAL SEWING MACHINES

Plaka, Dişli, İğne Bağı, Ayak  
Needle Plate, Needle Clamp,  
Feed Dog, Presser Foot



1-1  S10570-001 SL-B777(1/8)	1-2  S10572-001 SL-B777(3/16)	1-3  S10573-001 SL-B777(1/4)	1-4  S10574-001 SL-B777(3/8)	1-5  155722-001 LT2-B872-UT(1/8) LT2-B875-UT(1/8)	1-6  155851-001 LT2-B872-UT(3/16) LT2-B875-UT(3/16)
2-1  155853-001 LT2-B872-UT(1/4) LT2-B875-UT(1/4)	2-2  155855-001 LT2-B872-UT(5/16) LT2-B875-UT(5/16)	2-3  155857-001 LT2-B872-UT(3/8) LT2-B875-UT(3/8)	2-4  149677-001 LT2-B872-UT(1/2) LT2-B875-UT(1/2)	2-5  149954-001 LT2-B872-UT(5/8) LT2-B875-UT(5/8)	2-6  S11508-101 DT6-B927(2x1/4)
3-1  S05946-001 DT6-B927(2x3/16)	3-2  150666-001 DT6-B927(2x1/4)	3-3  148864-001 DT6-B298-6(2x1/8)	3-4  150667-001 DT6-B928-6(2x1/8)	3-5  146730-001 B511-001-3 146731-001 B511-001-4 146732-001 B511-001-5 146733-001 B511-001-6	3-6  146781-001 B531/B551-022-5 146782-001 B531/B551-022-6 146783-001 B531/B551-022-7
4-1  146785-001 B531-031-7	4-2  146786-001 B531-033-5	4-3  S01711-001 B531-022-5 S01713-001 B531-022-6	4-4  S19166-001 EF4-N21-27-5	4-5  S20232-001 MA4-N31-65-5 S20233-001 MA4-N31-65-6	4-6  S08723-001 FD4-B272-011 (3x5.6) S08724-001 FD4-B272-011 (3x6.4)

1-1  146734-001 B511-002-5 146735-001 B511-002-6 146736-001 B511-002-7	1-2  S19153-001 EF-N11-07-2	1-3  S19145-001 EF4-N11-01-4 S19146-001 EF4-N11-01-5	1-4  S19154-001 EF4-N11-01-4B S19155-001 EF4-N11-01-5B	1-5  S19156-001 EF4-N11-12-4	1-6  146498-001 B551-061/062-3
2-1  146501-001 B551-063/064-3 146502-001 B551-063/064-4 146503-001 B551-063/064-5	2-2  S25190-001 EF4-N21-22-4 S19162-001 EF4-N21-22-5	2-3  S25527-001 EF4-N21-22-4B S19169-001 EF4-N21-22-5B	2-4  146504-001 B551-065-5 146505-001 B551-065-6	2-5  146508-001 B551-069-5	2-6  146509-001 B551-071-6
3-1  146510-001 B551-087-6	3-2  S19182-001 MA4-N31-69-5	3-3  S19185-001 MA4-N31-92-5 S19186-001 MA4-N31-92-6	3-4  S20234-001 MA4-N31-63-3 S20235-001 MA4-N31-63-4 S20236-001 MA4-N31-63-5 S25196-001 MA4-N31-63-7	3-5  S08724-001-G FD4-B272-011(3x6.4)	3-6  S08731-001 FD4-B272-021-7(3x5.6) S08732-001 FD4-B272-021-8(3x6.4)
4-1  144635-001 HM-818A-3 B814-3	4-2  145246-001 HM-818A-2 B814-2/4	4-3  S51248-101 HE-800A-3/2	4-4  S50664-001 HE-800A-2	4-5  156150-001 LK3-B430 (1.8mm)	4-6  156151-001 LK3-B430(2.2 mm) 156152-001 LK3-B430(2.5 mm)



FOR INDUSTRIAL SEWING MACHINES

<p>1-1</p>  <p>166150-001(2.2) LK3-B430(2.2 mm) 166150-001(2.6) LK3-B430(2.6 mm) 166150-001(2.8) LK3-B430(2.8 mm)</p>	<p>1-2</p>  <p>S10211-001 KE-430C(1.6 mm) S10213-101 HS-034C(2.2 mm) S10212-101 KE-431C(2.6 mm) KE-436C/484C(2.6 mm)</p>	<p>1-3</p>  <p>S51449-001 BAS-311E(1.6 mm) KE-435C(1.6 mm) KE-484C(1.6 mm)</p>	<p>1-4</p>  <p>SA5221-001 BAS-311G(2.2 mm) SA5222-101 BAS-311G(3.0 mm)</p>	<p>1-5</p>  <p>S29997-001 BAS-311(2.6 mm)</p>	<p>1-6</p>  <p>SA3652-201 HS-034D(1.6 mm) SA3653-201 HS-034D(2.2 mm)</p>
<p>2-1</p>  <p>SA3654-201 BE-438D(1.6 mm) SA7502-001 BE-438D(2.0 mm)</p>	<p>2-2</p>  <p>SA3646-201 HS-034D(1.6 mm) SA3645-201 HS-034DD(2.2 mm)</p>	<p>2-3</p>  <p>SA3336-001 HS-034D(2.4 mm) BAS-311G(2.4 mm) BAS-326G(2.4 mm)</p>	<p>2-4</p>  <p>SA6133-001 BE-438D(1.6 mm)</p>	<p>2-5</p>  <p>SB0715-001 HS-034F(1.6 mm)</p>	<p>2-6</p>  <p>SB0953-001 BE-438F(1.6 mm) SB0712-001 BE-438F(2.0 mm)</p>
<p>3-1</p>  <p>SB0951-001 HS-034F(1.6 mm) SB0952-001 HS-034F(2.2 mm)</p>	<p>3-2</p>  <p>SB0949-001 HS-034F(2.4 mm)</p>	<p>3-3</p>  <p>SA8458-001 ZE-8560A</p>	<p>3-4</p>  <p>S48238-101 ZE-8560A</p>		
<p>4-1</p>  <p>SA3655-001 HS-034D BE-438D</p>	<p>4-2</p>  <p>SA5157-101 BAS-311G</p>	<p>4-3</p>  <p>S36622-001 BM-917B</p>			

FOR INDUSTRIAL SEWING MACHINES

<p>1-1</p>  <p>S10203-201 BAS-311F BAS-326F</p>	<p>1-2</p>  <p>152995-001 LK3-B430</p>	<p>1-3</p>  <p>S38015-001 HS-034C/034E</p>			
<p>2-1</p>  <p>B1190-522-X00 DLM-5200(3/32) B1190-522-Y00 DLM-5200(5/32) B1190-522-7/32 DLM-5200(7/32)</p>	<p>2-2</p>  <p>B1190-522-S00 DLM-5200(1/8) B1190-522-T00 DLM-5200(3/16)</p>	<p>2-3</p>  <p>B1190-522-S/64 DLM-5200(5/64) B1190-522-U00 DLM-5200(1/4) B1190-522-V00 DLM-5200(3/8) B1190-522-Y0B DLM-5200(5/16)</p>	<p>2-4</p>  <p>400-46303-1 APW-895(14 mm)</p>	<p>2-5</p>  <p>400-46301-1 APW-895(10 mm)</p>	
<p>3-1</p>  <p>400-46301 APW-895(10 mm)</p>	<p>3-2</p>  <p>400-46303 APW-895(14 mm)</p>	<p>3-3</p>  <p>B1103-380-B00 MH-380(2x3.2 mm)</p>	<p>3-4</p>  <p>B1103-380-D00 MH-380(2x4.8 mm)</p>	<p>3-5</p>  <p>B1103-380-F00 MH-380(2x6.4 mm)</p>	<p>3-6</p>  <p>B1103-380-K00 MH-380(2x9.5 mm)</p>
<p>4-1</p>  <p>129-23405 MS-1190(3/16)</p>	<p>4-2</p>  <p>22581409S.A LZ-2280</p>	<p>4-3</p>  <p>22548010A LZ-2280</p>	<p>4-4</p>  <p>B1137-352-000 MO-352</p>	<p>4-5</p>  <p>B1137-354-000 MO-354</p>	<p>4-6</p>  <p>B1136-357-A00 MO-357 B1136-357-B00 MO-357 B1136-357-C00 MO-357</p>



1-1  R4200-EOD-C00 MO-804 R4200-EOD-D0A MO-1004 R4300-E0F-E00 MO-804-0F6	1-2  R4200-LOE-E02 MO-3300	1-3  R4200-HOA-C00 MO-2504	1-4  R4200-JOA-C00 MO-3704	1-5  R4200-HOD-D00 MO-2504 R4200-HOE-D00 MO-2504	1-6  R4300-HOD-E00 MO-2504 R4300-HOF-E00 MO-2504-0F6
2-1  R4200-JOD-D00 MO-3904 R4200-JOE-D00 MO-3904 R4200-HOD-D00 MO-2504	2-2  R4300-JOE-E00 MO-3904	2-3  R4200-J6E-D00 MO-6700 MO-6900	2-4  R4200-LOE-D00 MO-3305E-0E4-41H	2-5  R4200-LOE-E00 MO-3304E-0E4-40H	2-6  R4300-LOF-E00 MO-3304E-0F6-50H
3-1  R4200-L2E-E00 MO-3304E-0E4	3-2  R4300-LOE-E00 MO-3304E-0E6-40H	3-3  R4608-LOE-G0A MO-3316E-DE6-42H	3-4  R4205-EOD-E00 MO-814-B04	3-5  R4305-EOD-E00 MO-814 R4305-EOD-E0A MO-1014	3-6  R4205-HOD-EA0 MO-2514 R4205-HOD-E00 MO-2514
4-1  R4305-HOD-E00 MO-2514 R4305-HOE-E00 MO-2414 R4305-HOF-E00 MO-2514	4-2  R4205-JOE-E00 MO-3914	4-3  R4305-JOD-E00 MO-3914 R4305-JOE-E00 MO-3916 R4305-JOF-E00 MO-3914	4-4  R4205-J6E-E00 MO-6714	4-5  R4305-J6E-E00 MO-6700 MO-6900	4-6  R4308-J6F-E0B MO-6700









1-1  S4305-JOB-E00 MO-6700	1-2  S4305-JOG-E00 MO-6700 S4305-J6D-E00 MO-6714	1-3  R4305-LOE-E00 MO-3314E-BE6-40H R4305-LOE-E0A MO-3314E-BE6-42H	1-4  R4508-EOD-C00 MO-816	1-5  R4508-HOD-D00 MO-2516 R4508-HOF-D00 MO-2516	1-6  R4608-HOD-F00 MO-2516 R4608-HOF-G00 MO-2516
2-1  R4612-HOF-G00 MO-2516 R4612-HOF-B0A MO-2514	2-2  R4508-JOE-D00 MO-3916	2-3  R4508-JOD-D00 MO-3916 R4508-JOF-D00 MO-3916	2-4  R4612-JOF-D0A MO-3916	2-5  R4612-JOF-F00 MO-3916 R4612-JOF-D00 MO-3916 R4612-JOF-G00 MO-3916	2-6  R4608-JOE-D00 MO-3916
3-1  R4608-JOF-D00 MO-3916 R4608-JOF-D0A MO-3916	3-2  R4508-J6E-D00 MO-6700 MO-6900 R4508-J6E-D0C MO-6700 R4612-J6F-D00 MO-6716	3-3  R4608-J6E-D00 MO-6716	3-4  R4612-J6H-K00 MO-6700-5/FH6	3-5  R4612-J6F-D00 MO-6716 R4612-J6F-K00 MO-6700/6500	3-6  R4508-LOE-G00 MO-3316E-DE4-40H
4-1  R4608-LOE-G00 MO-3316E-DE6-40H	4-2  R4608-LOE-G0A MO-3316E	4-3  R4612-LOF-L00 MO-3316-FF6-60H	4-4  R4612-LOF-G00 MO-3316E-FF6-40H	4-5  R4612-LOH-G00 MO-3316E-FH6-50H R4612-LOH-L00 MO-3316E-FH6-60H	4-6  R4612-HOD-E01 MO-2543 R4612-JOD-E01 MO-3943 R4612-J6D-E01 MO-6743



FOR INDUSTRIAL SEWING MACHINES

<p>1-1</p>  <p>R4612-LOD-E01 MO-3343</p>	<p>1-2</p>  <p>R4253-FOH-GOP MF-8600 (2x5.6)</p>	<p>1-3</p>  <p>R4354-FOH-GOB MF-8700 (3x6.4)</p>	<p>1-4</p>  <p>B2402-761-000 LBH-761</p>  <p>B2402-762-000 LBH-762</p>	<p>1-5</p>  <p>B2402-771-000 LBH-780</p>	<p>1-6</p>  <p>B2402-772-K00 LBH-772</p>
<p>2-1</p>  <p>400-27553 LBH-1790 400-27554 LBH-1790</p>	<p>2-2</p>  <p>400-04350 LBH-1790 400-04352 LBH-1790</p>	<p>2-3</p>  <p>B2529-373-000 MB-372/373</p>	<p>2-4</p>  <p>B2426-210-00A AMS-220C/210D (1.6 mm)</p>  <p>B2426-210-00B</p>  <p>B2426-210-00C</p>  <p>B2426-210-00F AMS-215C/220C/210D (2.0 mm/1.6 mm/3.0 mm)</p>	<p>2-5</p>  <p>B2426-280-000 LK-1850 (1.6 mm)</p>  <p>B2426-280-00B LK-1850 (2.0 mm)</p>	<p>2-6</p>  <p>B2426-280-00C LK-1850 (2.4 mm)</p>
<p>3-1</p>  <p>D8.15-11 LK-1850 (2.8 mm)</p>	<p>3-2</p>  <p>D2426-282-C00 LK-1900 (1.6 mm) LK-1903A (1.6 mm)</p>	<p>3-3</p>  <p>MAZ-15501000 LK-1903 (1.6 mm)</p>	<p>3-4</p>  <p>MAZ-15601000 LK-1903 (2.0 mm)</p>	<p>3-5</p>  <p>MAZ-15801000 LK-1903 (1.6 mm)</p>	<p>3-6</p>  <p>225-58407 LZ-2290</p>
<p>4-1</p>  <p>225-58308 LZ-2290</p>	<p>4-2</p>  <p>B2425-210-000 AMS-205C AMS-206C AMS-210D</p>	<p>4-3</p>  <p>400-30934 AMS-210E AMS-221E AMS-224E</p>			

FOR INDUSTRIAL SEWING MACHINES

<p>1-1</p>  <p>135-15564 LK-1850</p>	<p>1-2</p>  <p>135-15507 LK-1900</p>	
<p>2-1</p>  <p>400-06721 LK-1900A</p>	<p>2-2</p>  <p>142-13003 LK-1910 LK-1920</p>	
<p>3-1</p>  <p>B2401-761-0A0 LBH-760</p>	<p>3-2</p>  <p>B2401-771-0B0 LBH-780</p>	<p>3-3</p>  <p>400-04301 LBH-1790</p>
<p>4-1</p>  <p>B1241-373-000 MB-373</p>	<p>4-2</p>  <p>B1241-377-000 MB-377</p>	



<p>1-1</p>  <p>14-724 DWK-1802D (2x3.2) 14-734 DWK-1802D (2x4.0) 14-744 DWK-1802D (2x4.8) 14-754 DWK-1802D (2x5.6)</p>	<p>1-2</p>  <p>14-763 DWK-1802D (2x6.4) 14-764 DWK-1802D (2x6.4)</p>	<p>1-3</p>  <p>14-725 DWK-1802D (2x3.2) 14-735 DWK-1802D (2x4.0)</p>	<p>1-4</p>  <p>14-745 DWK-1802DE (2x4.8) 14-755 DWK-1802DE (2x5.6) 14-765 DWK-1802DE (2x6.4)</p>	<p>1-5</p>  <p>14-566 VT02-IS (2x6.4)</p>	<p>1-6</p>  <p>14-887 WX/RX-D (2x5.6)</p>
<p>2-1</p>  <p>14-888 WX/RX-D (2x6.4)</p>	<p>2-2</p>  <p>14-884 WX-D (2x3.2) 14-885 WX-D (2x4.0) 14-886 WX-D (2x4.8)</p>	<p>2-3</p>  <p>14-760 B2000C (2x6.4) DVK-1702BK (2x6.4)</p>	<p>2-4</p>  <p>14-806 WX-880 (2x3.2) 14-807 WX-880 (2x4.0) 14-808 WX-880 (2x4.8)</p>	<p>2-5</p>  <p>14-873 RX-P (2x4.0) 14-874 RX-P (2x4.8)</p>	<p>2-6</p>  <p>14-843 RX/C (2x4.8) 14-844 RX/C (2x5.6) 14-845 RX/C (2x6.4)</p>
<p>3-1</p>  <p>14-883 VW-C (2x4.8)</p>	<p>3-2</p>  <p>14-854 DWK-1803D (3x5.6) 14-864 DWK-1803D (3x6.4)</p>	<p>3-3</p>  <p>14-855 DWK-1803E (3x5.6) 14-865 DWK-1803E (3x6.4)</p>	<p>3-4</p>  <p>14-818 WX-8800 (3x5.6) 14-819 WX-8800 (3x6.4) 14-820 WX-8800 (3x5.6)</p>	<p>3-5</p>  <p>14-889 RX, WX (3x4.8)</p>	<p>3-6</p>  <p>14-890 RX, WX (3x5.6) 14-890H RX, WX (3x5.6)</p>
<p>4-1</p>  <p>14-891 RX, WX (3x6.4)</p>	<p>4-2</p>  <p>14-871 WX/DW (3x5.6)</p>	<p>4-3</p>  <p>14-880 WX/DX</p>	<p>4-4</p>  <p>14-876 RX-P (3x6.4)</p>	<p>4-5</p>  <p>14-896 RX, WX-CL (3x5.6) 14-897 RX, WX (3x6.4)</p>	<p>4-6</p>  <p>14-3010-1 DPW-1302W</p>

<p>1-1</p>  <p>14-3330</p>	<p>1-2</p>  <p>14-3320</p>	<p>1-3</p>  <p>14-3310</p>	<p>1-4</p>  <p>10400147</p>	<p>1-5</p>  <p>14-619 MZ-CL (3x5.6)</p>	<p>1-6</p>  <p>14-859 W8103E (3x5.6)</p>
<p>2-1</p>  <p>14-864B W8103D (3x6.4)</p>	<p>2-2</p>  <p>14-875 RX-P (3x5.6)</p>	<p>2-3</p>  <p>14-892 WX/AH (3x6.4)</p>	<p>2-4</p>  <p>14-801 W8103C (3x5.6) 14-802 W8103C (3x6.4)</p>	<p>2-5</p>  <p>14-846 RX/C (3x5.6) 14-847 RX/C (3x6.4)</p>	<p>2-6</p>  <p>14-860 WX-8800 (3x5.6) 14-861 WX-8800 (3x5.6) 14-862 WX-8800 (3x6.4)</p>
<p>3-1</p>  <p>14-854C W8103D (3x5.6)</p>	<p>3-2</p>  <p>14-854D W8103D (3x5.6)</p>	<p>3-3</p>  <p>14-8780-1 WX-CLW (3x5.6)</p>	<p>3-4</p>  <p>14-8790-1 RX/CL (3x5.6)</p>	<p>3-5</p>  <p>14-882 VW-C (3x5.6)</p>	<p>3-6</p>  <p>14-881 VW-C (3x6.4)</p>
<p>4-1</p>  <p>14-186 NW/NR/F (2x3.2) 14-187 NW/NR/F (2x4.0)</p>	<p>4-2</p>  <p>14-726 DWK1802F (2x3.2) 14-736 DWK1802F (2x4.0)</p>	<p>4-3</p>  <p>14-728 DWK1802EMK (2x3.2) 14-748 DWK1802EMK (2x4.8) 14-758 DWK1802EMK (2x5.6) 14-768 DWK1802EMK (2x6.4)</p>	<p>4-4</p>  <p>14-746 DWK1802F (2x4.8) 14-756 DWK1802F (2x5.6) 14-766 DWK1802F (2x6.4)</p>	<p>4-5</p>  <p>14-771 WX-EMK (2x3.2) 14-772 WX-EMK (2x4.0) 14-773 WX-EMK (2x4.8) 14-774 WX-EMK (2x5.6) 14-775 WX-EMK (2x6.4)</p>	<p>4-6</p>  <p>14-784 WX-EMK (2x3.2) 14-785 WX-EMK (2x4.0)</p>









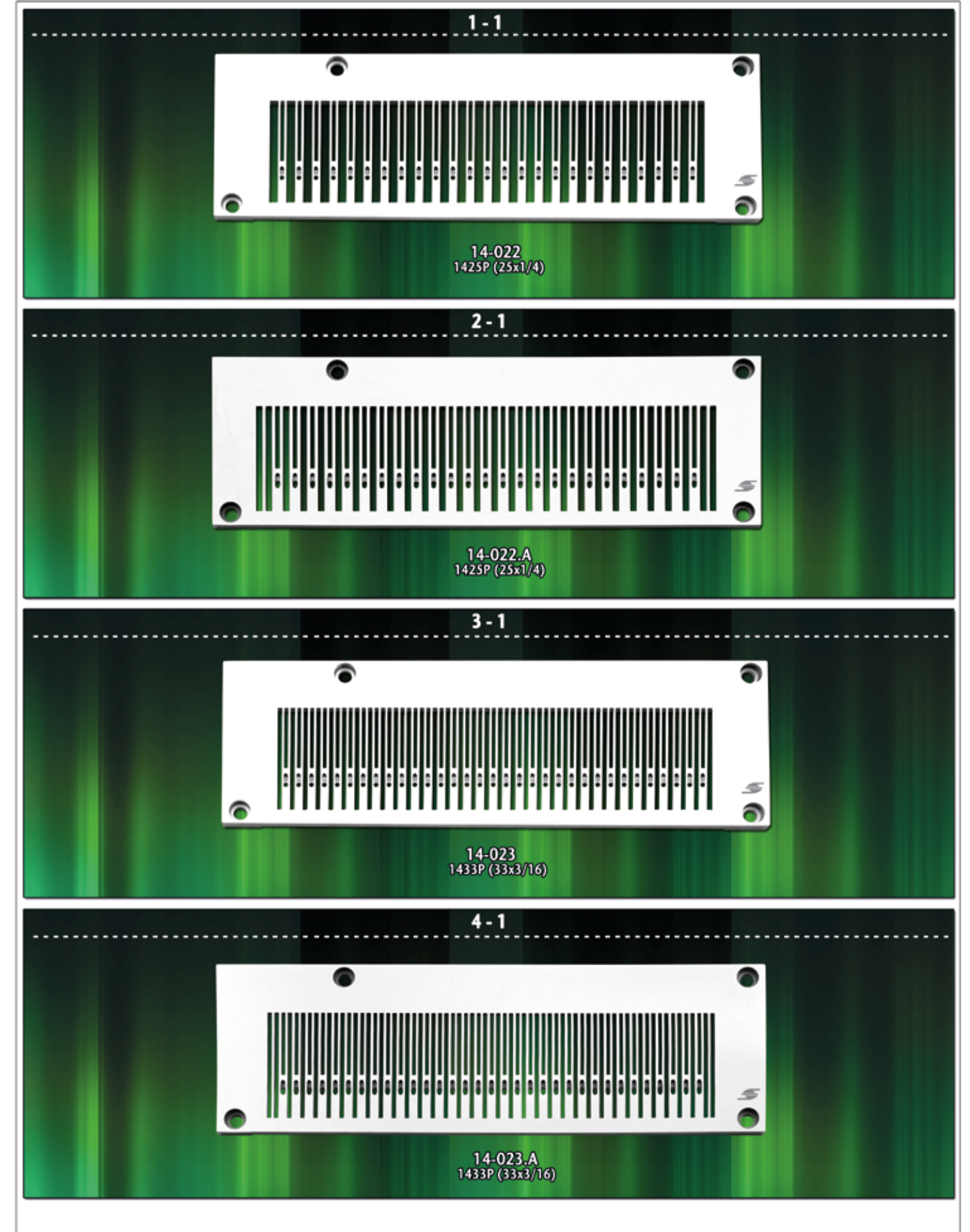
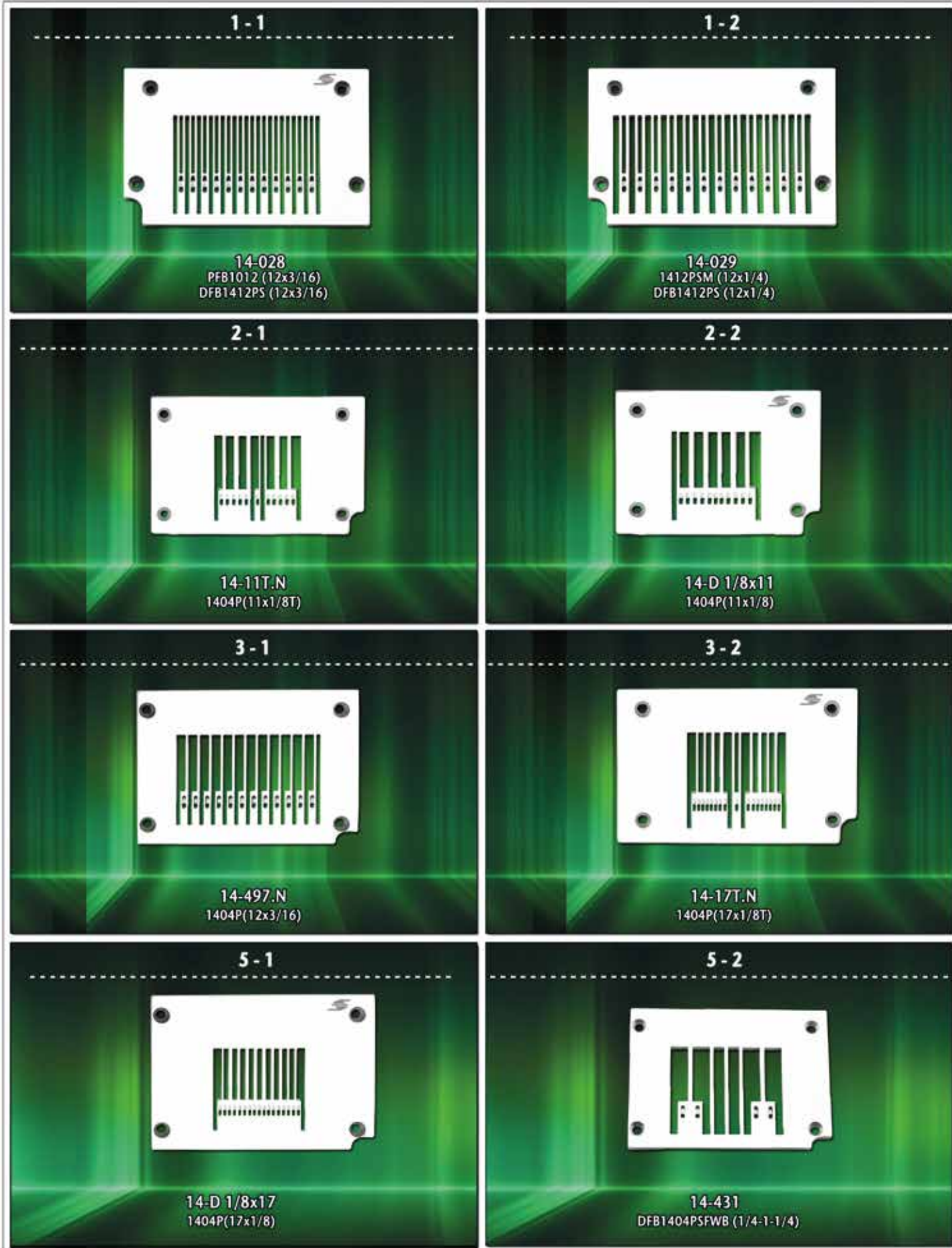

















1-1  14-786 8013-1S (2x4.8)	1-2  14-811 RX (2x4.0) 14-814 RX (2x4.8)	1-3  14-176 WX/UF-F (3x5.6) 14-177 WX/UF-F (3x6.4)	1-4  14-192 NW/NR/F (3x5.6)	1-5  14-856B W803F (3x5.6)	1-6  14-857 WX-F (3x4.8)
2-1  14-856 W8103F (3x5.6) 14-866 W8103F (3x6.4)	2-2  14-858 W8103EMK (3x5.6) 14-868 W8103EMK (3x6.4)	2-3  14-776 WX-EMK (3x5.6) 14-777 WX-EMK (3x6.4)	2-4  14-779 WX-EMK (3x4.8)	2-5  14-790 WX-EMK (3x5.6) 14-791 WX-EMK (3x6.4)	2-6  14-866B W8103F (3x6.4)
3-1  14-929 RX (3x5.6)	3-2  14-930 RX/PHK (3x6.4)	3-3  14-870 RX-XLK (3x4.8)	3-4  14-812 RX (3x5.6) 14-813 RX (3x6.4)	3-5  14-3170-1 PX	3-6  14-183 MZ/UF-A (2x4.8)
4-1  14-184 MZ/UF-A (3x5.6) 14-185 MZ/UF-A (3x6.4)	4-2  14-611 MZ-A (2x4.0) 14-612 MZ-A (2x4.8)	4-3  14-613 MZ-A (3x5.6) 14-614 MZ-A (3x6.4)	4-4  14-615 MZ-C (3x4.0)	4-5  14-616 MZ-C/UF (2x4.8)	4-6  14-617 MZ-C/UF (3x5.6) 14-618 MZ-C/UF (3x6.4)

1-1  57-011 KX1-3-505M12 (0x3)	1-2  57-021 UK11165-01H (5x5)	1-3  57-002 UK11165-01M/02M	1-4  57-012 UK11165-01H	1-5  57-022 UK1116H-03X	1-6  57-032 UK1116H-03X
2-1  57-042 UK11165-30M	2-2  57-052 KX1-6-516M71	2-3  14-800 RX/J	2-4  LX-045 LX5802 (2x8)	2-5  14-563 LX5802 (2x6.4)	2-6  14-553 1503PTF (3x6.4) 14-554 1503PTF (3x7.2)
3-1  14-581 DLR (1/4-1-1/4) 14-582 DLR (3/16-1-3/16) 14-583 DLR (1/4-3/4-1/4)	3-2  14-4180-0 140P (4x3/4)	3-3  14-421 DFB1404P (4x1)	3-4  14-443 1406P (6x1/4) 14-442 1406P (6x3/16)		
4-1  14-465 DFB1408P (8x1/4)	4-2  14-496 DFB1412P (12x1/4)	4-3  14-497 DFB1412P (12x3/16) 14-580 DFB1404P (12x1/8)			







1-1  TP2120014 UH80B3021L04	1-2  TP6B3022 SH60B3	1-3  TP6B30221 SH60B3	1-4  TP603032 SH6003	1-5  TP603053A SH6000	1-6  TP624A43 SH6024-A43-M14
2-1  TP604A32 SH6004-A32-M14	2-2  TP604A33 SH6004-A33-M14	2-3  TP604A42 SH6004-A42-M14	2-4  TP604A43 SH6004 TP604A53 SH6004	2-5  TP604B33 SH6004-B33-M14	2-6  TP604B53 SH6004-B53-M12
3-1  5210TP04A63 SH6004-A63-M14	3-2  5212TP0015 UH8004-243-M14	3-3  TP605C32 SH6005-C32 TP605C52 SH6005-C52	3-4  TP645C53 SH6045-C53-M16	3-5  TP675C53 SH6075-C53-M16	3-6  5212TP0035 UH8005
4-1  5210TP05C52 SH6005-C52	4-2  TP605C53 SH6005 TP605D53 SH6005	4-3  TP645D53 SH6045-D53-M16	4-4  5212TP0033 SH6000	4-5  GTP605D53 SH6005 GTP605D63 SH6005	4-6  TP634D03 SH6034

1-1  TP606CA3 SH6006	1-2  TP606DA3 SH6006-DA3-M43	1-3  TPC00561 FT6500 (3x5.6) TPC00641 FT6500 (3x6.4)	1-4  TPC13564 CT6213 (3x5.6)	1-5  5220TP00568 CT6500-L (3x5.6) 5220TP00646 CT6500-L (3x6.4)	1-6  5220TP00564 5220TP00566 FT7039-1-56M (3x5.6)	
2-1  5222TP11480 FT7001-0-48M (3x4.8) 5222TP11560 FT7001-0-56M (3x5.6)	2-2  TPF60600 FT6760 (4x6.0)	2-3  5220TP03560 KZ (3x5.6) 5222TP03400 KZ (3x4.0) 5222TP03480 KZ (3x4.8) 5222TP03640 KZ (3x6.4)	2-4  5220TP03563 CT4703 (3x5.6) 5220TP85641 CT6585 (3x6.4)	2-5  TPC42562 CT6542 (3x5.6)	2-6  5220TP85560 CT8556 (3x5.6) 5220TP85561 CT8556 (3x6.4)	
3-1  5222TPL1400 CT9311 (2x4.0) 5222TPL1480 CT9311 (2x4.8)	3-2  5222TPL1560 CT9311 (3x5.6) 5222TPL1640 CT9311 (3x6.4)	3-3  TPCL11561 CTL6511 (3x5.6)	3-4  5222TP13562 CT9013-2(3x5.6)	3-5  5222TP11400 FT7011-0-40M(2x4.0)	3-6  5220TP85400 CTD9085(2x4.0) 5220TP85480 CTD9085(2x4.8)	
4-1  5220TP42562 CT6542(3x5.6) CT9042(3x5.6) 5220TP42642 CT6542(3x6.4) CT9042(3x6.4)	PEGASUS 		4-2  202403 DCR-942	4-3  200954 DCM-204 140135 DCM-204	4-4  205465 L52-16 2054651 M852-1652	4-5  205773 L52-01 2057731 M852-01























1-1  202617 L52-01 202618 L52-01	1-2  202546E L52-17 202546E1 M852-17	1-3  202618A M752-180	1-4  205321 M752-53A/54A	1-5  204731A L52-17	1-6  209732 M752-181
2-1  210783 E52-211 210784 E52-211	2-2  210796 E52-130 210797 E52-130	2-3  210799 E52-130 210800 E52-130	2-4  277502P15 EX5204-32R2 277512P15 EX5204-32R2	2-5  277500P30 EX5204-01 277500P40 EX5204-01 277511S7000 EX5214-24/45S(K)	2-6  277504R30 EX5204-02 277504R40 EX5204-02 277504R50 EX5204-02 277504R60 EX5204-02
3-1  213111-60 EX5104	3-2  205255 L52-13	3-3  205243 L52-34	3-4  202554E L52-13 M852-13 202554E-H M752-13H (2x4)	3-5  202702 R57-05 202675 R57-05	3-6  209508-45 M752-23B
4-1  202983 M752-55A	4-2  210804 E52-132 210805 E52-132	4-3  210806 E32 E52	4-4  210809 E52-131 210810 E52-131	4-5  277505R30 EX5212 277505R40 EX5214 277505R50 EX5214 277505R60 EX5214-03/333K	4-6  204294B L32-30 204039B L32-30

1-1  204360A L32-70 204361A L32-70 204360A1 M832-70	1-2  204366 L32-38 204367 L32-38 204368 L32-38	1-3  204380 L32-76 (5x5)	1-4  204528 L32-86 204529 L32-86 2045291 M832-86	1-5  204939 L32-48 204940 L32-48 204941 L32-48	1-6  204943 L32-80 204944 L32-80 204945 L32-80
2-1  210837 E32-420 210838 E32-420 210839 E32-420 210840 E32-420	2-2  210845 E32-430 210846 E32-430 210847 E32-430 210848 E32-430	2-3  210868 E32-451	2-4  210980 E32-542 210981 E32-542 210982 E32-542	2-5  210987 E32-542 210986 E32-542	2-6  277513R40 EX3216 277513R50 EX3216
3-1  277513R50-N EX3216#2	3-2  277517R40 EX3216 277517R50 EX3216	3-3  277516R50 EX3216 277516R60 EX3216	3-4  277524T50 EX3216H 277524T60 EX3216H	3-5  277518R40 EX3244-03	3-6  277519R40 EX3244-03
4-1  208648 L32-355	4-2  257015B32 W562-01 (2x3.2) W664-01CB (2x3.2) 257015B40 W562-01 (2x4.0) W664-01CB (2x4.0) 257015B48 W562-01 (2x4.8) W664-01CB (2x4.8)	4-3  257111C48 W664-81AC (2x4.8)	4-4  257016B48 W562-01 (3x4.8)	4-5  257016B56 W562-01 (3x5.6) 259620B56 EX5204 (3x5.6) 259620B5601 WT2600 (3x5.6) 259620B6401 WT26002HENB (3x6.4)	4-6  257018B56H W562-01(3x5.6)



<p>1-1</p>  <p>257018A56 W562-01 (3x5.6) 257018B56 W562-01 (3x5.6) 257018B64 W562-01 (3x6.4) 257018B5601 W500/UT (3x5.6)</p>	<p>1-2</p>  <p>206276 W61-01 (3x5.6) 257001B56 W562-01 (3x5.6)</p>	<p>1-3</p>  <p>257082B56 W762L-01CB (3x5.6)</p>	<p>1-4</p>  <p>257018B56-N W664-01 (3x5.6)</p>	<p>1-5</p>  <p>257018C56 W562-01CC (3x5.6) 257018C64 W562-01CC (3x6.4)</p>	<p>1-6</p>  <p>257018D56 W562-01 (3x5.6)</p>
<p>2-1</p>  <p>257090B56 W562-03 (3x5.6) 257090B64 W562-03 (3x6.4)</p>	<p>2-2</p>  <p>257090C56 W542-03DC (3x5.6)</p>	<p>2-3</p>  <p>257097B56 W664-03 (3x5.6) 257097B64 W664-03 (3x6.4)</p>	<p>2-4</p>  <p>257105B56 W664-03GB (3x5.6) 257105B64 W664-03GB (3x6.4)</p>	<p>2-5</p>  <p>257108B56 W664-08 (3x5.6) 257108B64 W664-08 (3x6.4)</p>	<p>2-6</p>  <p>236035B56 W603 (3x5.6)</p>
<p>3-1</p>  <p>257020-60 W561 W562-01DB (4x6.0)</p>	<p>3-2</p>  <p>257023B32 W562-025B (2x3.2) 257024B40 W562-025B (2x4.0)</p>	<p>3-3</p>  <p>257029B32 W562-02 (2x3.2) 257030B40 W562-02 (2x4.0) 257030B48 W562-02 (2x4.8) 257032B56 W541-02BB (2x5.6)</p>	<p>3-4</p>  <p>206455 W562-02 (3x5.6)</p>	<p>3-5</p>  <p>257031B56 W541-02BB (3x5.6) W542-02BB (3x5.6)</p>	<p>3-6</p>  <p>257033A56 W562-02CA (3x5.6) 257033A64 W562-02CA (3x6.4)</p>
<p>4-1</p>  <p>257033B56 W562-02 (3x5.6) 257033B64 W562-02 (3x6.4)</p>	<p>4-2</p>  <p>257033C56-18 W562-02 (3x5.6)</p>	<p>4-3</p>  <p>257033C56-20 W562-02</p>	<p>4-4</p>  <p>257067B56 W756-202EB (3x5.6)</p>	<p>4-5</p>  <p>257049B32 W562-05 (2x3.2) 257050B40 W562-05 (2x4.0) 257050B48 W562-05 (2x4.8)</p>	<p>4-6</p>  <p>257051B48 W541-05BB (3x4.8) 257053B56 W562-05 (3x5.6) 257053B64 W562-05 (3x6.4)</p>

<p>1-1</p>  <p>257102B56 W664-35 (3x5.6) 257102B64 W664-35 (3x6.4)</p>	<p>1-2</p>  <p>257102C56 W664-35C (3x5.6) W664-35AB (3x5.6) 257012C64 W664-35AB (3x6.4)</p>	<p>1-3</p>  <p>257100B40 W664-34AB (2x4.0) 257100B48 W664-34AB (2x4.8)</p>	<p>1-4</p>  <p>2Q0018B56D0 W1662-32B (3x5.6) 2Q0018B64D0 W1662-32B (3x6.4)</p>	<p>1-5</p>  <p>259608B56 W562-01 (3x5.6)</p>	<p>1-6</p>  <p>259614B56 WT-200 (3x5.6)</p>
<p>2-1</p>  <p>SIRUBA</p> <p>E934 737-504M1-15</p>	<p>2-2</p>  <p>E783 E784 737-505F1-04 737-505F1-04</p>	<p>2-3</p>  <p>E796 E797 737-504M3-04 737-504M3-05</p>	<p>2-4</p>  <p>E800 E800C 737-504M2-04 737-504M2</p>	<p>2-5</p>  <p>E800D 737-504H4-04</p>	
<p>3-1</p>  <p>E589F 737-504M5-04</p>	<p>3-2</p>  <p>E590 737E-504M2/BK</p>	<p>3-3</p>  <p>E591E 747-203BK</p>	<p>3-4</p>  <p>E591F 747F-514/BK</p>	<p>3-5</p>  <p>E591B 747-203BK</p>	<p>3-6</p>  <p>E804 E804A E805 E805A 747-514M4-23 747-512M8-23 747-514M4-24 747-512M8-24</p>
<p>4-1</p>  <p>E809 E809A E919 E919A 747-514M2-24 747-514M7-24 747-514M2-24 747-514M7-24</p>	<p>4-2</p>  <p>E810 E810A E920 E920A 747-512M1-25 747-512M8-25 747-512M1-25 747-512M8-25</p>	<p>4-3</p>  <p>E810L 747</p>	<p>4-4</p>  <p>E839 757-516L1-35</p>	<p>4-5</p>  <p>E982 757-516M2-35</p>	<p>4-6</p>  <p>E986 757-516M2-55</p>



1-1  E868 757-516H2-56	1-2  E870 757-56	1-3  E871 757FX-56	1-4  E871C 757	1-5  E988 767-516M2	1-6  E989 767-516M2
2-1  E232 737-504MS-04-BK	2-2  E1524 F007E-W122 (2x4.0) E3525P C007F-W122 (2x4.8) E1525 F007E-W122 (2x4.8)	2-3  E1535 F007E-W123 F007E-UTG (2x4.8)	2-4  E3524P C007E-W122 (2x4.0)	2-5  E3525P C007E-W122 (2x4.8)	2-6  E1836L F007E-U613 (2x5.6) E1837L F007E-U613 (2x6.4)
3-1  E2324P C007E-WS42 (2x4.0) E2325P C007E-WS42 (2x4.8)	3-2  E3524R C007E-U122/CH (2x4.0)	3-3  E8148 (2x4.8)	3-4  E8801 (2x4.8)	3-5  E8811 (3x5.6) E8821 (3x6.4)	3-6  E2625P C007E-U322/CF (2x4.8)
4-1  E1816 (3x5.6) E1817 (3x6.4)	4-2  E1826 F007E (3x5.6) E1827 F007E (3x6.4)	4-3  E1826H (3x5.6)	4-4  E1846 F007E-W162 (3x5.6) E1847 F007E-W162 (3x6.4)	4-5  E3816P (3x5.6) E3817P (3x6.4)	4-6  E3826 C007D (3x5.6) E3826P C007/CH (3x5.6) E3827 C007 (3x6.4) E3827P C007E/CH (3x6.4)



1-1  E3826-H C007E-US12/FE-FFC (3x5.6)	1-2  E3836 C007D-W121 (3x5.6) E3837 C007D-W121 (3x6.4)	1-3  E3846 C007H-W162/UP (3x5.6) E3847 C007H-W162/UP (3x6.4)	1-4  E3826R C007E-U122/CH (3x5.6) E3827R C007E-U122/CH (3x6.4)	1-5  E2326P C007J-W132/CHE (3x5.6)	1-6  E4826 F007 (3x5.6)
2-1  E4836M F007E/FDE (3x5.6)	2-2  E2626P C007E/CE (3x5.6) E2627P C007E/CE (3x6.4)	2-3  E2826P C007-U322/CC (3x5.6) E2827P C007-U322/CC (3x6.4)	2-4  E3626P C007E/CD (3x5.6) E3627P C007E/CD (3x6.4)	2-5  E1828 F007E-W922/FW (4x6.0)	2-6  E5827 U712,UT12/FSR (2x6.4)
3-1  E6828 WT22/FY (3x8.8)	3-2  E3024 F007E-W222 (2x4.0) E3025 F007E-W222 (2x4.8)	3-3  E4124P C007E-W222/CQ (2x4.0)	3-4  E3727 F007J-W272/FSM (3x6.4)	3-5  E3326 F007/FQ (3x5.6) E3326P F007E/FQ (3x5.6) E3327 F007/FQ (3x6.4) E3327P F007E/FQ (3x6.4)	3-6  E4326 C007D/CQ (3x5.6) E4326P C007E-W152/U152 (3x5.6) E4327 C007D/CQ (3x6.4) E4327P C007E-W152/U152 (3x6.4)
4-1  E6024 F007E-WS22/FE (2x4.0)	4-2  E6426R C007J-WS22 (3x5.6) E6427R C007J-WS22 (3x6.4)	4-3  E4426 C007E/CQ (3x5.6) E4426P C007E/U222/CQ (3x5.6) E4427 C007E/CQ (3x6.4) E4427P C007E/U222/CQ (3x6.4)	4-4  E6326 F007E-WS22 FE(FFC)/FR (3x5.6) E6327 F007E-WS22 FE(FFC)/FR (3x6.4)	4-5  E6426 C007E-WS32/CRA/UTP CL/RCP/CX (3x5.6)	4-6  E6427P C007J-U532/CRA (3x6.4)



1-1  E0215R (2x4.8)	1-2  E0225Q C007J-W812A (2x4.8) E0225R C007J-W822 (2x4.8)	1-3  E0235 C007J-W813A (2x4.8)	1-4  E0216R (3x5.6) E0217R (3x6.4)	1-5  E0226P C007J-W812/CRL/RL (3x5.6)	1-6  E0226Q C007J-W812A (3x5.6) E0227Q C007J-W812A (3x6.4)
2-1  E3966P (3x5.6)	2-2  E3967 (3x6.4)	2-3  E705Q L818F-RM (1/8) E705R L818F-RM (5/32) E705 L818F-RM (3/16) E705P L818F-RM (3/32)	2-4  E705T L818F-RM (3/8) E705S L818F-RM (1/4)	2-5  E137 (2.2 mm)	2-6  E137P (2.2 mm)
3-1  E138 (2.6 mm)	3-2  E139 (1.6 mm)	3-3  E139P (1.6 mm)	3-4  E140 (1.6 mm)	3-5  E141 (2.0 mm)	
4-1  E9104D VC008-04085P	4-2  E9012 VC008-06048P	4-3  E9112 VC008-06064P	4-4  E9113 VC008-133P (1/4x1/8x1/8xx1/4)x3		

1-1  E9313 VC008-13-032P (13x1/8)	1-2  E9117A VC008-17 (17x1/8)	1-3  E9123A VC008-23 (23x1/8)			
	2-1  34893 DCZ-200-D1 34894 DCZ-200-D1 36279 DCZ-703	2-2  32671 DCZ-203 (2.5 mm) 32672 DCZ-203 (3.5 mm) 32673 DCZ-203 (4.5 mm)	2-3  34566 DCZ-503-D3	2-4  37289 DC-12 37483 DCY-114	2-5  32666 DCY-114 32667 DCZ-200-D2
	3-1  2108017 AZ-8016	3-2  2108000 AZ-6000H-04	3-3  2108002 AZ-6003H-03 (0x3) AZ-8000H-03 (0x3)	3-4  2108003 AZ-6003H-04 (0x4) AZ-8003H-04 (0x4)	3-5  2108008 AZ-6000H/AZ-8000H /AZ-8000G
	3-6  2108100 AZ800H-5				
4-1  21787 Z5020-Y6	4-2  33353 (32678) DCZ-220W-D1	4-3  33353A (4 mm) DCZ-220-D1 33353A (5 mm) DCZ-220-D1	4-4  34598 DCZ-520-D1	4-5  36304 DCZ-724Y	4-6  2108004 AZ8020H-Y5 2108005 AZ8020H-Y6



<p>1-1</p>  <p>620800 CZ6000(2.4x5) 620802 CZ6000(2.4x6)</p>	<p>1-2</p>  <p>2108006 AZ-6020H/AZ-6020H-4 /AZ-8020H/AZ-8000G</p>	<p>1-3</p>  <p>2158003</p>	<p>1-4</p>  <p>2158011</p>	<p>1-5</p>  <p>2108062 AZ8032H-Y5</p>	<p>1-6</p>  <p>2108064 AZ8032H-Y7</p>
<p>2-1</p>  <p>27002 ZF-1500-X 27004 ZF-1500-X</p>	<p>2-2</p>  <p>33541 DCZ-361A-D2 DCZ-365A/DCZ-367A</p>	<p>2-3</p>  <p>33545 DCZ-361C</p>	<p>2-4</p>  <p>35334 DCZ-341</p>	<p>2-5</p>  <p>2108050 AZ-8500-A4</p>	<p>2-6</p>  <p>2108052 AZ-8500-C5 2108076 AZ8500H-C5</p>
<p>3-1</p>  <p>93170 VF-2400 (2x3.2) 93171 VF-2400 (2x4.0) 93172 VF-2400 (2x4.8)</p>	<p>3-2</p>  <p>3508000 VG2700 (2x3.2) 3508001 VG2700 (2x4.0)</p>	<p>3-3</p>  <p>3108130 VF-2200 (2x3.2) 3108131 VF-2200 (2x4.0) 3108132 VF-2200 (2x4.8)</p>	<p>3-4</p>  <p>93410 DV1250-M (12x4.0) 93417 DV1266/VC2700 VG2700-M (2x4.8)</p>	<p>3-5</p>  <p>94801-L-DC (4.0) DW-1350 (2x4.0) 94801-L5 DW-1350 (2x5.6)</p>	<p>3-6</p>  <p>94800 DW1350-MC (3x4.8) 95493 VF-2500L (3x5.6)</p>
<p>4-1</p>  <p>90166 DW-100 (3x5.6) 90167 DW-100 (3x6.4) 94801 DW-1350 (3x5.6) 94801-L-DC(5.6) DW-1350 (3x5.6) 94802 DW-1350 (3x6.4)</p>	<p>4-2</p>  <p>3108133 VF2300-156M (3x4.8) 3108134 VC-2700 (3x5.6) 3108135 VC-2700 (3x6.4)</p>	<p>4-3</p>  <p>3108134.H VF2300-156M (3x5.6) 3108134 VC-2700 (3x5.6)</p>	<p>4-4</p>  <p>3108134D VF-2300 (3x5.6) 3108134.N VF2300-156M (3x5.6)</p>	<p>4-5</p>  <p>94801-L2 VF-2500 (3x5.6)</p>	<p>4-6</p>  <p>94801-L2-05 VF-2500 (3x5.6)</p>

<p>1-1</p>  <p>94801-LC VF-2500 (3x5.6)</p>	<p>1-2</p>  <p>94801C 94801C-L5 VF-2500 (3x5.6)</p>	<p>1-3</p>  <p>94801D DW-1350 (3x5.6) 94801D-L5 DW-1350 (3x5.6)</p>	<p>1-4</p>  <p>94801-N VF-2500 (3x5.6) 94801-N-2 VF-2500 (3x5.6) 94801-N-5 VF-2500 (3x5.6) 94801-FS VC-2613 (3x5.6)</p>	<p>1-5</p>  <p>94801B VC2700C (3x5.6)</p>	<p>1-6</p>  <p>94802-L5 DW1350/DW1500/DW1700 (3x6.4)</p>
<p>2-1</p>  <p>3508002 VG-2700 (3x4.8)</p>	<p>2-2</p>  <p>3508003 VG-2700 (3x5.6)</p>	<p>2-3</p>  <p>3508004 VG-2700 (3x6.4)</p>	<p>2-4</p>  <p>3008021 VC-2700 (3x5.6)</p>	<p>2-5</p>  <p>3508087 VG2713(P)-156KM-KM VG2713-156M</p>	<p>2-6</p>  <p>3108141-N 3108140-NS VF-2300 (3x5.6)</p>
<p>3-1</p>  <p>3508008 VC2700 (3x5.6)</p>	<p>3-2</p>  <p>3158006 VE-2713-156L (3x5.6) 3158082 VE-2713-156L (3x5.6)</p>	<p>3-3</p>  <p>3158012 VE-2713-156S (3x5.6) 3158094 VE-2713-156S (3x5.6)</p>	<p>3-4</p>  <p>3108136 (4x6.0)</p>	<p>3-5</p>  <p>94281 VF-2403 (2x3.2)</p>	<p>3-6</p>  <p>94283 VF-2403 (2x4.8)</p>
<p>4-1</p>  <p>95234 VF-1403 (2x4.0)</p>	<p>4-2</p>  <p>94210 DV-1253MA (2x3.2) 94211 DV-1253MA (2x4.0) 94212 DV-1253MA (2x4.8)</p>	<p>4-3</p>  <p>95260 DV-1409 (2x3.2)</p>	<p>4-4</p>  <p>95261 DV-1409 (2x4.0) 95262 DV-1409 (2x4.8)</p>	<p>4-5</p>  <p>3208097 VF-2539 (2x3.2) 3208096 VF-2539 (2x4.0)</p>	<p>4-6</p>  <p>90556 DW-303 (3x5.6) 90557 DW-303 (3x6.4)</p>



FOR INDUSTRIAL SEWING MACHINES













1-1  91764 DW-103 (3x5.6) 91765 DW-103 (3x6.4) 94901 DW-1353 (3x5.6) 94902 DW-1353 (3x6.4)	1-2  95085 VF-2503 (3x5.6)	1-3  3108002 VG2735-D (3x5.6) 3108003 VG2735-164M (3x6.4)	1-4  3268014 VFS-2511 (3x6.4)	1-5  3008025 VF-2503-11 (3x6.4)	1-6  3208026 VF-2503 (3x4.8)
2-1  3208108 VF-2303 (3x5.6)	2-2  3208093 VF-2539 (3x5.6) 3208094 VF-2539 (3x6.4)	2-3  95278 DW-1509 (3x5.6) 95279 DW-1509 (3x6.4)	2-4  3118023 VC-3711 (2x5.6)	2-5  3118025 VC-3711 (3x5.6) 3118026 VC-3711 (3x6.4)	2-6  3508098 VG3721-140S (2x4.0)
3-1  3508099 VG-3721 (3x4.8) 3508100 VG-3721 (3x5.6) 3508101 VG-3721 (3x6.4)	3-2  68490 FD-62 (4x6.0)	3-3  6508023 VT-1500 (3x5.6)	3-4  68491	3-5  004182	3-6  MITSUBISHI
4-1  MS02A1-101 PLK-2010.A1710 (1.6/2.2/3.0/3.2 mm)	4-2  MS14A0472 PLK-1006/0604				

FOR INDUSTRIAL SEWING MACHINES





















1-1  241372 10FE	1-2  164178 246-D	1-3  282188 457U	SUN STAR 1-4  GP-001320-00 SC7300 (3x5.6)		1-5  GP-006766-00 SC7300 (3x6.4)
2-1  GP-012184-00 SF75001BN (3x5.6) GP-012185-00 SF75001BN (3x6.4)	2-2  GP-009973-00 SC7310 (3x5.6) GP-010244-00 SC7310 (3x6.4)	2-3  10-140A-120H SPS/A-B1201 GP-021183-00 SPS/A-1306-HS			
3-1  10-143A-120K SPS/A-B120 (1.6 mm) 10-041A-120H SPS/B-B1201H (2.3 mm)	3-2  10-043A-120M SPS/B-B1201M (2.0 mm)	3-3  12000410B000 B-1306HS (2.0 mm) 12000510B000 B-1306HS (2.3 mm)	3-4  12000610B000 B1306H (2.5 mm)		
4-1  UNION SPECIAL 36210 36200		4-2  36224A 362	4-3  PFAFF 91-150868-24 91-150876-93		4-4  91-150882-25 91-150877-91











FOR INDUSTRIAL SEWING MACHINES

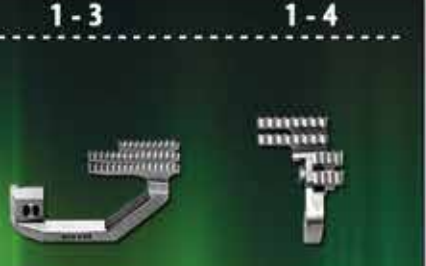
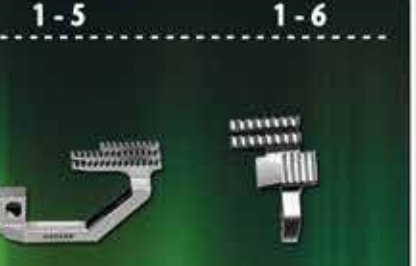

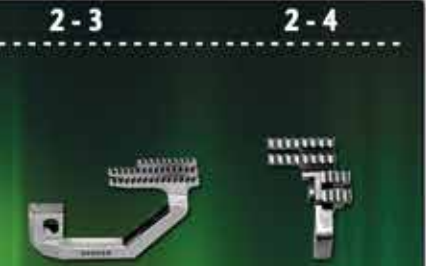

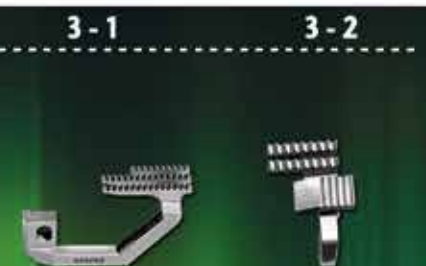
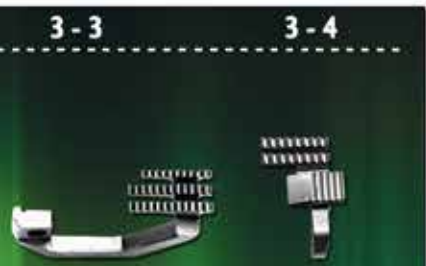











<p><b>1-1</b></p>  <p>91-150882-25</p>  <p>91-150880-91</p>	<p><b>1-2</b></p>  <p>91-150868-24</p>  <p>91-150879-91</p>
<p><b>2-1</b></p>  <p>91-150625-24</p>  <p>91-150728-23/004</p>	<p><b>2-2</b></p>  <p>91-150625-24/007</p>  <p>91-150728-23/007</p>
<p><b>3-1</b></p>  <p>91-150913-04-002</p>	<p><b>3-2</b></p>  <p>91-150913-04-001</p>
<p><b>4-1</b></p>  <p>91-012609-XP</p>	<p><b>4-2</b></p>  <p>91-141518-25</p>

FOR INDUSTRIAL SEWING MACHINES

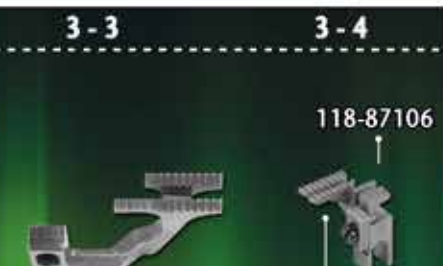
<p><b>1-1</b></p>  <p>149675-001 LT2-B845-UT (1/2) LT2-B872-UT (1/2) LT2-B875-UT (1/2)</p>	<p><b>1-2</b></p>  <p>149948-001 LT2-B845-UT (1/8) LT2-B872-UT (1/8) LT2-B875-UT (1/8)</p>	<p><b>1-3</b></p>  <p>149691-001 LT2-B845-UT (5/16) LT2-B872-UT (5/16) LT2-B875-UT (5/16)</p>	<p><b>1-4</b></p>  <p>149938-001 LT2-B845-UT (3/8) LT2-B872-UT (3/8) LT2-B875-UT (3/8)</p>	<p><b>1-5</b></p>  <p>148699-001 LT2-B845-UT (1/8) LT2-B872-UT (1/8) LT2-B875-UT (1/8)</p>	<p><b>1-6</b></p>  <p>148703-001 LT2-B845-UT (3/16) LT2-B872-UT (3/16) LT2-B875-UT (3/16)</p>
<p><b>2-1</b></p>  <p>148705-001 LT2-B845-UT (3/16) LT2-B872-UT (3/16) LT2-B875-UT (3/16)</p>	<p><b>2-2</b></p>  <p>S40370-001 DT6-B927 6.4 mm (1/4)</p>	<p><b>2-3</b></p>  <p>150673-001 DT6-B928 6.4 mm (1/4)</p>	<p><b>2-4</b></p>  <p>148867-101 DT6-B928-6 DT6-B928-7 (3.2 mm x 2) (1/8 x 2)</p>	<p><b>2-5</b></p>  <p>150675-101 DT6-B928-6 DT6-B928-8A (3.2 mm x 2) (1/8 x 2)</p>	<p><b>2-6</b></p>  <p>S40369-001 DT6-B927-8-4.8 mm (3/16) DT6-B927-8 (4.8 mm x 2) (3/16 x 2)</p>
<p><b>3-1</b></p>  <p>148932-101 DT6-B928-6 (4.8 mm x 2) (3/16 x 2)</p>	<p><b>3-2</b></p>    <p>146748-001 146744-001 146577-001 EF4-B511-01 (0x3) (0x4) (0x5)</p>		<p><b>3-4</b></p>    <p>156036-001 146744-001 146577-001 EF4-B531-022 (0x3) (2.2x5) EF4-B531-023 (0x3) (2.2x6)</p>		
<p><b>4-1</b></p>  <p>S49030-001</p>	<p><b>4-2</b></p>  <p>S49029-001</p>	<p><b>4-3</b></p>    <p>146572-001 146567-001 146577-001 MA4-B551-063 (3x3) (3x4) (3x5) MA4-B551-064 (3x3) (3x4) (3x5)</p>		<p><b>4-5</b></p>    <p>146573-001 146568-001 146577-001 MA4-B551-065 (5x5)</p>	













<p>1-1 1-2</p>  <p>146574-001 146569-001 146577-001</p> <p>MA4-B551-087 (5x5) MA4-B551-092 (5x5)</p>	<p>1-3 1-4</p>  <p>S19236-001 S19199-001</p> <p>EF4-N11-01-4 (0x4) EF4-N11-01-5 (0x5) EF4-N11-01-6 (0x5)</p>	<p>1-5 1-6</p>  <p>S19240-001 S19212-001</p> <p>EF4-N11-01-4 (B) (C) (0x4) EF4-N11-01-5 (B) (C) (0x5) EF4-N11-01-6 (B) (C) (0x6)</p>
<p>2-1 2-2</p>  <p>S25574-001 S19210-001</p> <p>EF4-N11 (07-2)</p>	<p>2-3 2-4</p>  <p>S19240-001 S19217-001</p> <p>EF4-N21-22-4 (2.2x4) EF4-N21-22-5 (2.2x5)</p>	<p>2-5 2-6</p>  <p>S19237-001 S19202-001</p> <p>EF4-N21-27-5 (2.2x5)</p>
<p>3-1 3-2</p>  <p>S19240-001 S19212-001</p> <p>EF4-N21-41-5 (2.2x5)</p>	<p>3-3 3-4</p>  <p>S19244-101 S19219-001</p> <p>EF4-N21-45-5 (2.2x5)</p>	<p>3-5 3-6</p>  <p>S20243-001 S20242-001 S20245-001 S20241-101</p> <p>MA4-N31-63-3 (3x3) MA4-N31-63-4 (3x4) MA4-N31-63-5 (3x5)</p>
<p>4-1 4-2</p>  <p>S20244-001 S20239-001 S19223-101 S20240-001</p> <p>MA4-N31-65-5 (5x5) MA4-N31-65-6 (5x6)</p>	<p>4-3 4-4</p>  <p>S19247-001 S19228-001 S19223-101 S19229-001</p> <p>MA4-N31-5050-55-E3W (5x5)/(5x6) FB-N310-5050-55-E3W (5x5)/(5x6)</p>	<p>4-5 4-6</p>  <p>S38597-001 S38595-001 S19223-101 S38596-001</p> <p>MA4-N31-4050-55-E3W (5x5)/(5x6) FB-N310-4050-55-E3W (5x5)/(5x6)</p>





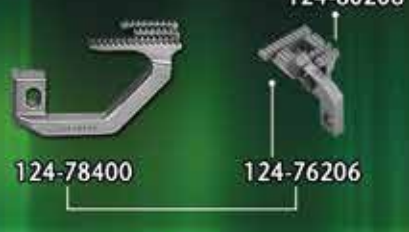





<p>1-1</p>  <p>B1613-380-B00 MH-380-1/8 (2x1/8)</p>	<p>1-2</p>  <p>B1613-380-D00 MH-380-3/6 (2x3/16)</p>	<p>1-3</p>  <p>B1613-380-F00 MH-380-1/4 (2x1/4)</p>	<p>1-4</p>  <p>B1613-380-K00 MH-380-3/8 (2x3/8)</p>	<p>1-5</p>  <p>129-32307 MS-1190 (2x3/16)</p>	<p>1-6</p>  <p>22548119A LZ-2280</p>
<p>2-1</p>  <p>22581508A LZ-2280</p>	<p>2-2 2-3</p>  <p>118-85100 118-82206 118-87106</p> <p>MO-2504-OD6-300 (0x3.2)</p>	<p>2-4 2-5</p>  <p>118-86504 118-82404 118-87106</p> <p>MO-2514-BO6-340 (2x3.2) MO-2414-BE6 (2x4)</p>			
<p>3-1</p>  <p>B1657-804-00T MO-2504-OD4-FG (0x3.2) MO-2504-OE4-300 (0x4.0) (0x3.2) MO-3094-OE4-FG (0x4.0)</p>	<p>3-2</p>  <p>118-87106 118-82107</p>	<p>3-3 3-4</p>  <p>B1657-814-B0E 115-97101 118-87106</p> <p>MO-2514-BD4-200 MO-2514-BD4-200-FG MO-2514-BD4 (2.0x3.2) MO-2514-BD4-FG</p>	<p>3-5 3-6</p>  <p>118-85209 118-82800 118-87403</p> <p>MO-2516-DD4-300 (3.2x3.2) (3.2x4.8)</p>		
<p>4-1</p>  <p>118-85407 MO-2516-FF6-500 (4.8x4.8)</p>	<p>4-2</p>  <p>118-87304 118-83006</p>	<p>4-3 4-4</p>  <p>118-86009 118-84004 118-87403</p> <p>MO-2543-FBD6-300 MO-2543-FBD6-300-FG (4.8x2.0x3.2)</p>	<p>4-5 4-6</p>  <p>124-78004 124-76008 124-80000</p> <p>124-760A6 MO-3304E-OE4-40H (0x3.6)</p>		





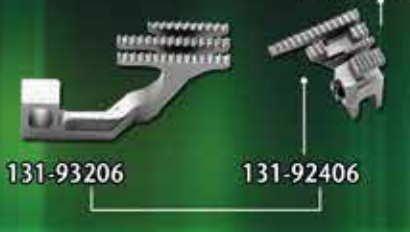

FOR INDUSTRIAL SEWING MACHINES









<p>1-1 1-2</p>  <p>124-78806 124-76701</p> <p>124-767A9 MO-3304E-OF6-50H (0x4.8)</p>	<p>1-3 1-4</p>  <p>124-79101 124-76800</p> <p>124-768A8 MO-3304E-DE4-40H (0x3.1) MO-3304E-DE4-Z192 (0x3.1)</p>	<p>1-5 1-6</p>  <p>124-78301 124-76305</p> <p>124-763A3 MO-3305E-OE4-41H (0x3.4) MO-3305E-OE4-L121 (0x3.4)</p>
<p>2-1 2-2</p>  <p>B1657-804-00T 118-82107</p> <p>MO-3904E-OE4(0x4.0) MO-3904E-OE4-FG(0x4.0)</p>	<p>2-3 2-4</p>  <p>124-78103 124-76107</p> <p>124-761A5 MO-3314E-BE6-44H/G41/Q148(2.2x3.6) MO-3314E-BE6-40H(2.2x3.6)</p>	<p>2-5 2-6</p>  <p>124-78707 124-76602</p> <p>124-766A0 MO-3314E-BE6-42H(2.2x3.6) MO-3314E-BE6-S170(2.2x3.6)</p>
<p>3-1 3-2</p>  <p>124-78202 124-76206</p> <p>124-762A4 MO-3316E-DE4-40H (3x3.8)</p>	<p>3-3 3-4</p>  <p>124-78905 124-76206</p> <p>124-762B2 MO-3316E-DE6-40H (3x3.8) MO-3343 (4.8x2.2x3.2)</p>	<p>3-5 3-6</p>  <p>124-78608 124-76503</p> <p>124-765A1 MO-3316E-DE6-42H (3x3.8) MO-3316E-DE6-S169 (3x3.8)</p>
<p>4-1 4-2</p>  <p>124-78400 124-76206</p> <p>124-762C0 MO-3316E-FF6-40H (4.8x4.8)</p>	<p>4-3 4-4</p>  <p>124-78509 124-76404</p> <p>124-764A2 MO-3316E-FF6-60H (4.8x4.8) MO-3316E-FF6-50H (4.8x6) MO-3316E-FF6-60H (4.8x6)</p>	<p>4-5 4-6</p>  <p>B1657-804-00T 118-82107</p> <p>MO-3604/MO-3616 MO-3704/MO-3716 MO-3714/MO-3904</p>

FOR INDUSTRIAL SEWING MACHINES















<p>1-1 1-2</p>  <p>121-73407 121-70908</p> <p>MO-3716-FF6-320-42H</p>	<p>1-3 1-4</p>  <p>119-49906 119-49807</p> <p>118-87106</p> <p>MO-3914-BE6 (2.0x4.0) MO-3914-BE6-FG (2.0x4.0)</p>	<p>1-5 1-6</p>  <p>121-72805 118-82800</p> <p>118-87403</p> <p>MO-3916-OE4 (3.2x4.0) MO-3916-OE4-FG (3.2x4.0)</p>
<p>2-1 2-2</p>  <p>121-73209 118-82909</p> <p>118-87403</p> <p>MO-3916-DE6 (3.2x4.0)</p>	<p>2-3 2-4</p>  <p>121-73308 118-84004</p> <p>118-87403</p> <p>MO-3916-FF6 (4.8x4.8) MO-3916-FF6-FG (4.8x4.8) MO-3943-FBD6-347/G07/Q141 (4.8x2x3.2) MO-6716-FF6-40H (4.8x4.8) MO-6743-ID6-40H (4.8x2x3.2)</p>	<p>2-5 2-6</p>  <p>131-92802 131-91606</p> <p>131-91309</p> <p>MO-6704-OE4-40H (0x4.0)</p>
<p>3-1 3-2</p>  <p>121-72003 121-71500</p> <p>118-87106</p> <p>MO-6714-BE6-20H (2x4.0)</p>	<p>3-3 3-4</p>  <p>121-73209 118-82909</p> <p>118-87403</p> <p>MO-6716-DE6-40H (3.2x4.0)</p>	<p>3-5 3-6</p>  <p>B1657-804-00C B1656-804-000</p> <p>B1658-804-000</p> <p>MO-804-OD4 (0x3.2)</p>
<p>4-1 4-2</p>  <p>131-93206 131-92406</p> <p>131-91408</p> <p>MO-6000</p>	<p>4-3 4-4</p>  <p>15-870 15-875</p> <p>KANSAI SPECIAL</p> <p>WX/DW CW CLW</p>	<p>4-5 4-6</p>  <p>15-823 15-808</p> <p>WX8803C-7/32" (3x5.6) WX8803C-1/4" (3x6.4)</p>





<p>1-1 1-2</p>  <p>15-807 15-808</p> <p>WX8703D-7/32" (3x5.6) WX8803D-1/4" (3x6.4)</p>	<p>1-3 1-4</p>  <p>15-805 15-806</p> <p>WX8802D (2x3.2) WX8802D (2x4.0) WX8802D (2x4.8)</p>	<p>1-5 1-6</p>  <p>15-723 15-724 15-753 15-755</p> <p>DVK1702D/V7002D/ DVK1702DE/V7002DE 1/8" (2x3.2) 5/32" (2x4.0) DWK1802D/W8002D/ DWK1802DE/W8002DE 3/16" (2x4.8) 7/32" (2x5.6) 1/4" (2x6.4) DVK1703D/DVK1703DE V7003D/V7003DE DWK1803D/DWK1803E 7/32" (3x5.6) 1/4" (3x6.4)</p>
<p>2-1 2-2</p>  <p>15-880 15-881</p> <p>RX9000DW/CLW</p>	<p>2-3 2-4</p>  <p>15-809 15-867</p> <p>RX9000AHD</p>	<p>2-5 2-6</p>  <p>57-201 57-105 57-106 57-1010-1</p> <p>UK2004S-01M (0x4) UK2014H-01M (2x4) UK2014H-01M (2x5)</p>
<p>3-1 3-2</p>  <p>57-211 57-115 57-126 57-1210-1</p> <p>UK2004S-20F (0x1.5)</p>	<p>3-3 3-4</p>  <p>57-211 57-115 57-116 57-1110-1</p> <p>UK2005S-10M (0x3) UK2005S-10M (0x4)</p>	<p>3-5 3-6</p>  <p>57-201 57-105 57-116 57-1310-1</p> <p>UK2014H-40M (2x4) UK2014H-40M (2x5)</p>
<p>4-1 4-2</p>  <p>57-202 57-107 57-108 57-1020-1</p> <p>UK216S-01M (3x4) UK216S-02M (3x5)</p>	<p>4-3 4-4</p>  <p>57-222 57-127 57-118 57-1220-1</p> <p>UK2116H-03X (5x5) UK2116H-03X (5x6)</p>	<p>4-5 4-6</p>  <p>57-212 57-117 57-108 57-1120-1</p> <p>UK2116S-01H (5x5)</p>

<p>1-1 1-2</p>  <p>57-232 57-137 57-108 57-1320-1</p> <p>UK2116S-30M (3x4)</p>	<p>1-3 1-4</p>  <p>57-232 57-147 57-108 57-1420-1</p> <p>UK2116S-30M (5x5)</p>	<p>1-5 1-6</p>  <p>57-242 57-117 57-108 57-1120-1</p> <p>UK2143H-90M (3x2x4)</p>
<p>2-1 2-2</p>  <p>15-805 15-843</p> <p>WX-D (3x5.6)</p>	<p>2-3 2-4</p>  <p>15-807 15-844</p> <p>WX-D (3x6.4)</p>	<p>2-5 2-6</p>  <p>15-811 15-812</p> <p>WX-F (3x5.6)</p>
<p>3-1 3-2</p>  <p>15-855 15-856</p> <p>RX-A (3x5.6) RX-D (3x5.6)</p>	<p>3-3 3-4</p>  <p>15-857 15-858</p> <p>RX-1144</p>	<p>3-5 3-6</p>  <p>15-853 15-854</p> <p>RX-ALK/PLK</p>
<p>4-1 4-2</p>  <p>15-860 15-859</p> <p>RX-C (2x4.8)</p>	<p>4-3 4-4</p>  <p>15-862 15-861</p> <p>RX/C (2x5.6) (2x6.4)</p>	<p>4-5 4-6</p>  <p>15-836 15-837</p> <p>WX8842-1</p>

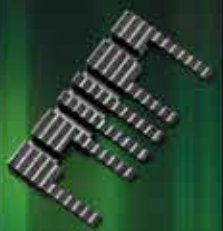
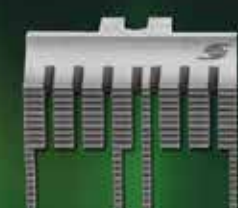
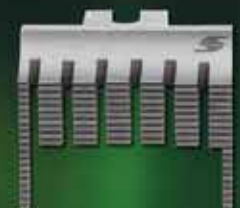
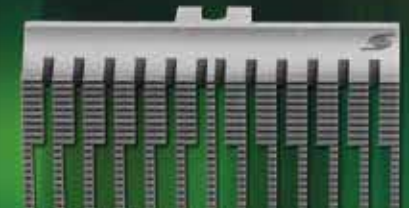

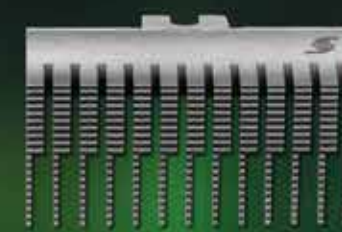
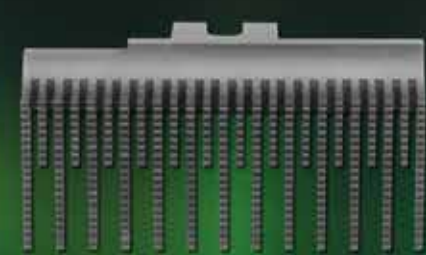
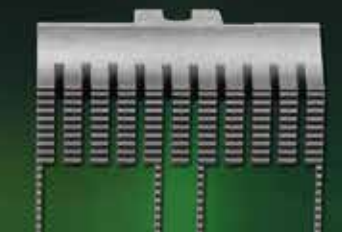
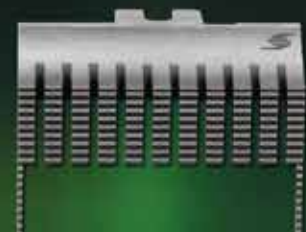
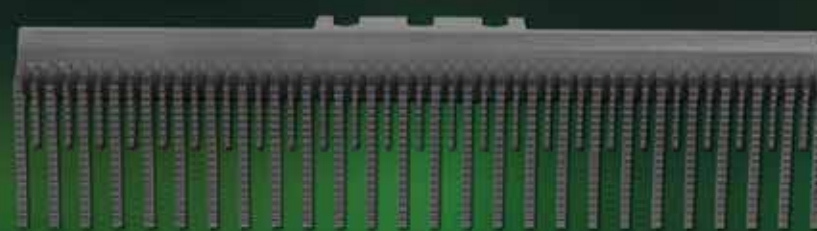
<p>1-1</p>  <p>15-566</p>		<p>1-2</p>  <p>15-565</p>		<p>1-3</p>  <p>15-615</p>		<p>1-4</p>  <p>15-614</p>		<p>1-5</p>  <p>15-536</p>		<p>1-6</p>  <p>15-535</p>	
LX5802		MX-158		LX-582							
<p>2-1</p>  <p>15-361</p>		<p>2-2</p>  <p>15-301</p>		<p>2-3</p>  <p>15-315</p>		<p>2-4</p>  <p>15-318</p>		<p>2-5</p>  <p>15-704</p> <p>DVK1702E-3/16" (2x4.8)                  DVK1702E-1/4" (2x6.4)                  DVK1702E-7/32" (2x5.6)                  DVK1703E-1/4" (3x6.4)                  DVK1703E-7/32" (3x5.6)                  B2000-1/4 (2x6.4)                  1702BK (2x6.4)</p>			
PX302-4W		PX302-5W									
<p>3-1</p>  <p>15-760</p> <p>B2000C</p>		<p>3-2</p>  <p>15-553</p> <p>1503PHD</p>		<p>3-3</p>  <p>15-421</p> <p>1404P (1)</p>		<p>3-4</p>  <p>15-418</p> <p>1404P (3/4)</p>		<p>3-5</p>  <p>15-442</p> <p>1406P (6x3/16)</p> <p>15-443</p> <p>1406P (6x1/4)</p>		<p>3-6</p>  <p>15-581</p> <p>DLR1508P-E (1/4x1x1/4)</p>	
<p>4-1</p>  <p>15-11T</p> <p>KS1404P (11x1/8T)(1/8x4)x1/4x1/4x(1/8x4)                  KS1404P (11x1/8)</p>		<p>4-2</p>  <p>15-D 1/8x11</p> <p>KS1404P (11x1/8T)(1/8x4)x1/4x1/4x(1/8x4)                  KS1404P (11x1/8)</p>		<p>4-3</p>  <p>15-496</p> <p>DFB1412P (12x1/4)</p>							

<p>1-1</p>  <p>15-497</p> <p>DFB1472P (12x3/16) KS1404P (12x1/8) KS1404P (12x3/16)</p>		<p>1-2</p>  <p>15-046</p> <p>DFB1412/PFB1012 (12x3/16)</p>		<p>15-047</p> <p>1412PSM (12x1/4)</p>	
<p>2-1</p>  <p>15-17T</p> <p>KS1404P (17x1/8T)(1/8x7)x1/4x1/4(1/8x7)                  KS1404P (17x1/8)</p>		<p>2-2</p>  <p>15-D 1/8x17</p> <p>KS1404P (17x1/8T)(1/8x7)x1/4x1/4(1/8x7)                  KS1404P (17x1/8)</p>			
<p>3-1</p>  <p>15-024</p> <p>1425PL (25x1/4)</p>					
<p>4-1</p>  <p>15-024.A</p> <p>1425PL (25x1/4)</p>					



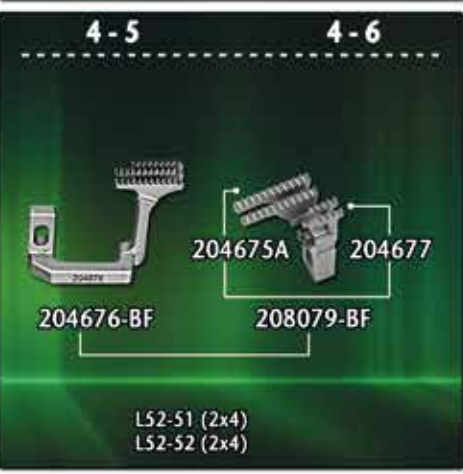
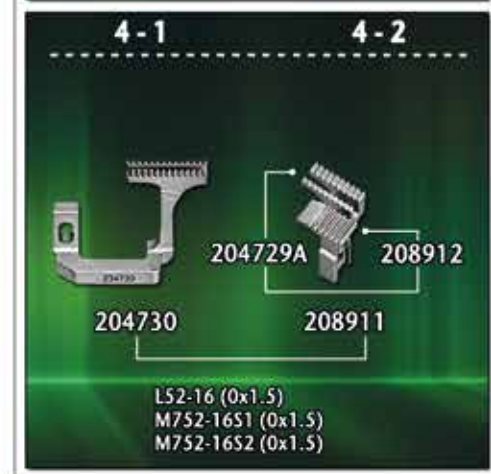
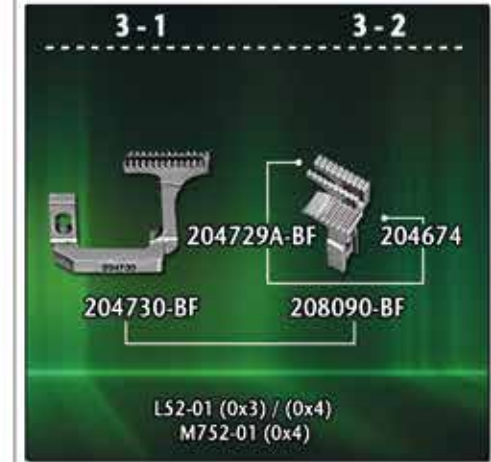
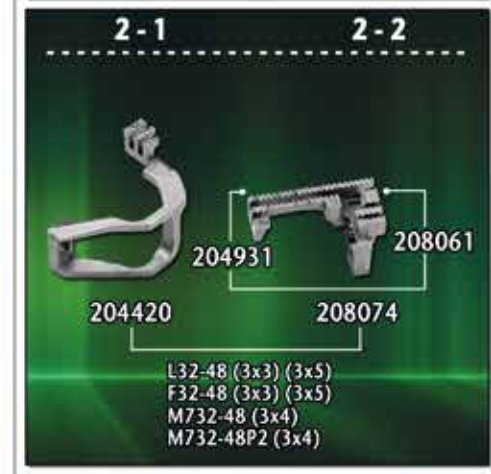
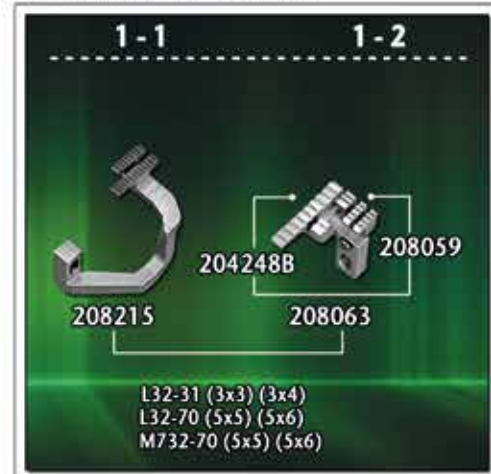
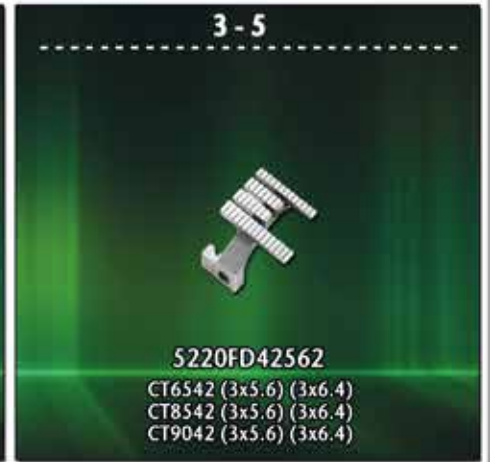
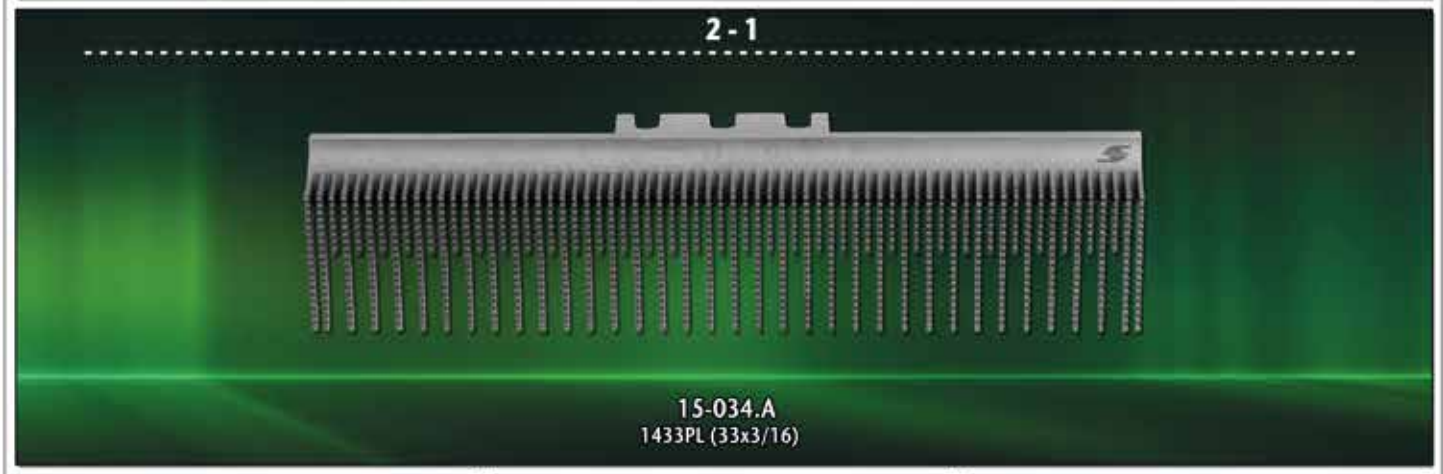
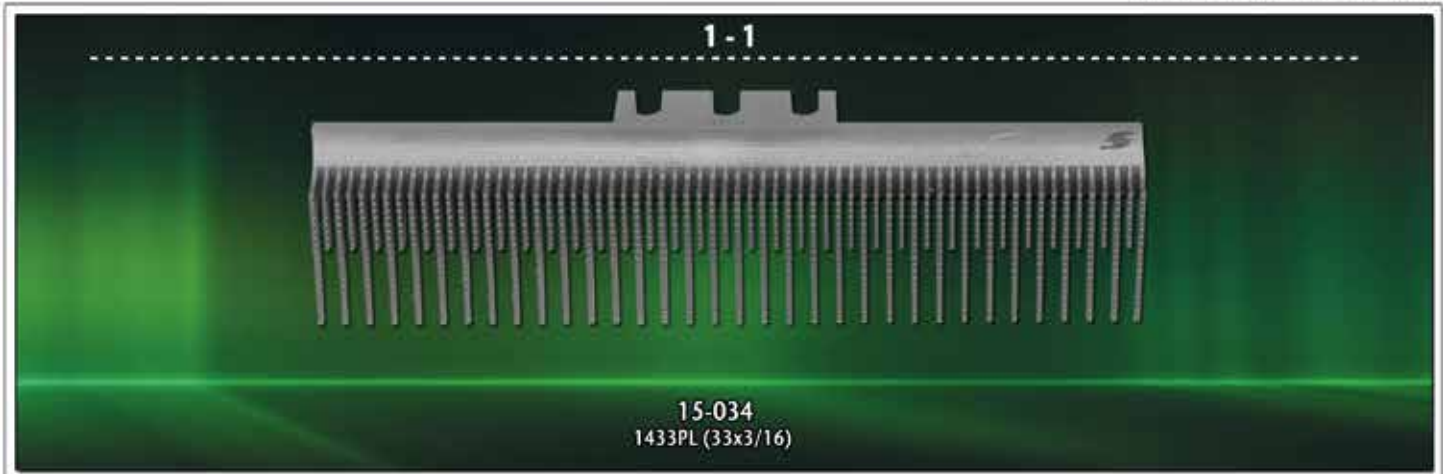



























<p>1-1 1-2</p> <p>208218 204395 204425 208065</p> <p>M732-36 (3x3) (3x4) (3x5)</p>	<p>1-3 1-4</p> <p>204730A16F 204729B-16F 204674 208090A16F</p> <p>M752-180 (0x4)</p>	<p>1-5 1-6</p> <p>209742-16F 209741-16F 204677 209740-16F</p> <p>M752-181 (2x4)</p>
<p>2-1 2-2</p> <p>209417A25F 209416-25F 204674 209509-25F</p> <p>M752-23B (2.5x4.5)</p>	<p>2-3 2-4</p> <p>204693 204692A 204677 208083</p> <p>M752-53A (0x4) M752-54A (0x4)</p>	<p>2-5 2-6</p> <p>204693-BF 204692ABF 204677 208083-BF</p> <p>M752-55A (2x4)</p>
<p>3-1 3-2</p> <p>2082190 2043960 2080600 2080660</p> <p>M832-38 (3x4)</p>	<p>3-3 3-4</p> <p>2082150 204248B0 2080590 2080630</p> <p>M832-70 (5x5)</p>	<p>3-5 3-6</p> <p>2082170 2043940 2080590 2080640</p> <p>M832-86 (5x5)</p>
<p>4-1 4-2</p> <p>204730 204729ABF0 2046740 208090-BF0</p> <p>M852-01 (0x4)</p>	<p>4-3 4-4</p> <p>204676-BF0 204675A0 2046740 208078-BF0</p> <p>M852-13 (2x4) (2x5) M852-17 (0x4)</p>	<p>4-5 4-6</p> <p>2047300 204729A0 2089120 2089110</p> <p>M852-1652 (0x1.5)</p>

<p>1-1 1-2</p> <p>202734 202733</p> <p>DCR-942</p>	<p>1-3 1-4</p> <p>277302-16F 277301-16F 277318-13 277300-16F</p> <p>EX5204-01/223K (0x3) (0x4) EX5205-12/233K (0x3) (0x4) EX5203-12/233K (0x3) (0x4)</p>	<p>1-5 1-6</p> <p>277305-16F 277304-16F 277318-13 277303-16F</p> <p>EX5204-02/223K (2x3) (2x4) (2x5) EX5212-02/333K (2x3) (2x4) (2x5) EX5214-53C3/333K (2x4) (2x5)</p>
<p>2-1 2-2</p> <p>277305-16F 277304-16F 277318-13 277303-16F</p> <p>EX5204-02/223K (2x3)(2x4)(2x5) EX5212-02/333K (2x3)(2x4)(2x5) EX5214-53C3/333K (2x3)(2x4)(2x5)</p>	<p>2-3 2-4</p> <p>277305-16F0 277304-16F0 277318-130 277303-16F0</p> <p>EXT5204-02/233(K) 0x4 EXT5214-43/333(K) 2x4</p>	<p>2-5 2-6</p> <p>277305-16F 277304-16F 277318-13 277303-16F</p> <p>EX5203-22/233K (0x5) EX5203-22/233K (0x6)</p>
<p>3-1 3-2</p> <p>277339-25 277338-25 277318-13 277337-25</p> <p>EX3215-04/435K (5x5) (5x6) EX3216-04/435K (5x5) (5x6)</p>	<p>3-3 3-4</p> <p>277302-16F 277301-16F 277309-13 277315-16F</p> <p>EX5204-32R2/223L(K) (0x1.5) EX5204-32R2/223(K) (0x1.5)</p>	<p>3-5 3-6</p> <p>277325-16 277324-16 277318-13 277323-16</p> <p>EX3216-02/223K (3x4) (3x5)</p>
<p>4-1 4-2</p> <p>277325-160 277324-160 277318-130 277323-160</p> <p>EXT3215-02/233(K) (3x4)</p>	<p>4-3 4-4</p> <p>277330-16 277328-16 277318-13 277327-16</p> <p>EX3216-03/233K (3x4) (3x5)</p>	<p>4-5 4-6</p> <p>277329-16 277328-16 277318-13 277327-16</p> <p>EX3216-03/233K (5x5) (5x6)</p>





















<p>1-1</p>  <p>257258-16F</p> <p>1-2</p>  <p>257206-16F</p> <p>W561 (2x3.2) (2x4.0) (2x4.8) (3x4.8) W562-01-CB/CC (2x3.2) (2x4.0) (2x4.8) (3x4.8)</p>	<p>1-3</p>  <p>257259-16F</p> <p>1-4</p>  <p>257207-16F</p> <p>W561 (3x5.6) (3x6.4) W562-01CA/CB/CC (3x5.6) (3x6.4)</p>	<p>1-5</p>  <p>257253-16F</p> <p>1-6</p>  <p>257207-16F</p> <p>W561-03 DB (3x5.6) (3x6.4) W562-03 DB (3x5.6) (3x6.4) W664-02BA (3x5.6) (3x6.4)</p>
<p>2-1</p>  <p>257256-16F</p> <p>2-2</p>  <p>257203A16F</p> <p>W561 (4x6) W562-01 DB (4x6)</p>	<p>2-3</p>  <p>257260-16F</p> <p>2-4</p>  <p>257214-16F</p> <p>W561 (2x3.2) W562-02 BB/BC (2x3.2)</p>	<p>2-5</p>  <p>257261-16F</p> <p>2-6</p>  <p>257215-16F</p> <p>W561 (2x4.0) (2x4.8) W562-02 BB/BC (2x4.0) (2x4.8)</p>
<p>3-1</p>  <p>257262-16F</p> <p>3-2</p>  <p>257216-16F</p> <p>W561 (3x5.6) (3x6.4) W562-02 BB/BC (3x5.6) (3x6.4)</p>	<p>3-3</p>  <p>259128-16F0</p> <p>3-4</p>  <p>259234-16F0</p> <p>W562-02PB (2x3.2)</p>	<p>3-5</p>  <p>257266-16F</p> <p>3-6</p>  <p>257220-16F</p> <p>W562-05 BB (2x3.2) W562-05 BB (2x4.0) W562-05 BB (2x4.8)</p>
<p>4-1</p>  <p>257268-16F</p> <p>4-2</p>  <p>257222-16F</p> <p>W562-05BB (3x5.6) W562-05BB (3x6.4)</p>	<p>4-3</p>  <p>257289-16F</p> <p>4-4</p>  <p>257242-16F</p> <p>W664-01CB (2x3.2) W664-01CB (2x4.0) W664-01CB (2x4.8)</p>	<p>4-5</p>  <p>257290-16F</p> <p>4-6</p>  <p>257243-16F</p> <p>W664-01CB (3x5.6) W664-01CB (3x6.4)</p>

<p>1-1</p>  <p>257291-16F</p> <p>1-2</p>  <p>257244-16F</p> <p>W664-02BB (2x3.2) W664-02BB (2x4.0) W664-02BB (2x4.8)</p>	<p>1-3</p>  <p>257293-16F</p> <p>1-4</p>  <p>257246-16F</p> <p>W664-02BB (3x5.6) W664-02BB (3x6.4)</p>	<p>1-5</p>  <p>259215-16F</p> <p>1-6</p>  <p>259103-16F</p> <p>W664-03FB (3x5.6) W664-03FB (3x6.4)</p>	
<p>2-1</p>  <p>259202-16F</p> <p>2-2</p>  <p>259100-16F</p> <p>W664-34AB (2x4.0) W664-34AB (2x4.8)</p>	<p>2-3</p>  <p>259203-16F</p> <p>2-4</p>  <p>259101-16F</p> <p>W664-35BB (3x5.6) W664-35BB (3x6.4)</p>	<p>2-5</p>  <p>259110-16F</p> <p>2-6</p>  <p>3G-007016F</p> <p>W1662-32B (3x5.6) W1662-32B (3x6.4)</p>	
<p>3-1</p>  <p>259106-16F</p> <p>3-2</p>  <p>259218A16F</p> <p>W2664H-33A (3x5.6)(3x6.4)</p>	<p><b>SIRUBA</b></p>  <p>H974 D969 D675 D390</p> <p>737-S04M-04,05</p>		<p>3-5</p>  <p>H445</p> <p>3-6</p>  <p>D440 D095 D575</p> <p>737-S04M2-04 (0x4) 747-S12M1-24 (2x4) (2x5) 747-S14M2-24CF-B (2x4)</p>
<p>4-1</p>  <p>H442</p> <p>4-2</p>  <p>D438 D912 D290</p> <p>737-S04M1-15 (0x4)</p>	<p>4-3</p>  <p>H442</p> <p>4-4</p>  <p>D438 D674 D569</p> <p>737-S05F1-03 (0x3) 737-S05F1-04 (0x4)</p>	<p>4-5</p>  <p>H497</p> <p>4-6</p>  <p>D489 D502 D581</p> <p>757-S16M2-35 (3x5)</p>	











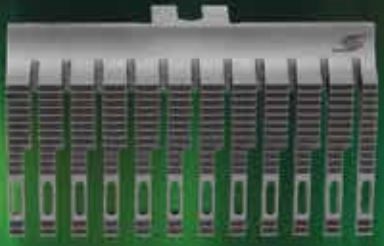

<p>1-1</p>  <p>H500</p> <p>D489</p> <p>1-2</p>  <p>D581</p> <p>D502</p> <p>757-516M2-55 (5x5)</p>	<p>1-3</p>  <p>H501</p> <p>D490</p> <p>1-4</p>  <p>D582</p> <p>D502</p> <p>757-516X2-56 (5x6)</p>	<p>1-5</p>  <p>H497</p> <p>D971</p> <p>1-6</p>  <p>D502</p> <p>767-516M2-324 (3x2x4)</p>
<p>2-1</p>  <p>H500</p> <p>D972</p> <p>2-2</p>  <p>D502</p> <p>767-516M2-524 (5x2x4)</p>	<p>2-3</p>  <p>H3362</p> <p>2-4</p>  <p>D3216</p> <p>C007E-U222/CQ (3x5.6) C007E-W222/CQ (2x4.0) C007H-W222/CQ (2x4.0) (2x4.8)</p>	<p>2-5</p>  <p>H4258 H4259</p> <p>2-6</p>  <p>D4206 D4207</p> <p>C007E-W122/CH (2x4.0) (3x5.6) (3x6.4) C007H-W122/CH (3x5.6) (3x6.4) C007H-W162 (2x4.0) (3x5.6) (3x6.4) C007H-U162 (2x4.0) (3x5.6) (3x6.4)</p>
<p>3-1</p>  <p>H3262</p> <p>3-2</p>  <p>D3216</p> <p>C007E-W152/CZ (3x5.6) C007E-W152/CZ/UTP/RLO (3x5.6)</p>	<p>3-3</p>  <p>H4158</p> <p>3-4</p>  <p>D4206</p> <p>C007E-W332/CD (3x5.6)</p>	<p>3-5</p>  <p>H3159</p> <p>3-6</p>  <p>D2107</p> <p>C007E-W332/CE (3x5.6)</p>
<p>4-1</p>  <p>H3268</p> <p>4-2</p>  <p>D3222</p> <p>C007J-W522 (3x5.6) (3x6.4)</p>	<p>4-3</p>  <p>H2203R</p> <p>4-4</p>  <p>D2101R</p> <p>C007J-W822 (3x4.8) (3x5.6) (3x6.4)</p>	<p>4-5</p>  <p>H4458 H4459</p> <p>4-6</p>  <p>D4206 D4207</p> <p>C007JD-W121/CH (3x5.6) C007JD-W121/CH (3x6.4)</p>

<p>1-1</p>  <p>H3362 H3363</p> <p>1-2</p>  <p>D3216 D3217</p> <p>C007H-W222/CQ (3x5.6) C007H-W222/CQ (3x6.4)</p>	<p>1-3</p>  <p>H1258</p> <p>1-4</p>  <p>D1206</p> <p>F007E-W122/UTG (2x4.0) F007E-W122/UTG (2x4.8)</p>	<p>1-5</p>  <p>H1259</p> <p>1-6</p>  <p>D1207</p> <p>F007H-W222/FQ (3x5.6) (3x6.4) F007E-W922/FW (4x6.0)</p>
<p>2-1</p>  <p>H1261</p> <p>2-2</p>  <p>D1215</p> <p>W222-240 (2x4.0) W222-248 (2x4.8)</p>	<p>2-3</p>  <p>H1262</p> <p>2-4</p>  <p>D1216</p> <p>F007E-W222/FQ (3x5.6) F007E-W222/FQ (3x6.4)</p>	<p>2-5</p>  <p>H1359</p> <p>2-6</p>  <p>D1207</p> <p>F007H-W322/FDC (3x5.6)</p>
<p>3-1</p>  <p>D9104</p> <p>VC008-04085P (4x1)</p>	<p>3-2</p>  <p>D9108</p> <p>VC008-08064P (8x1/4)</p>	<p>3-3</p>  <p>D9012</p> <p>VC008-12048P VC008-06048P (12x3/16)</p>
<p>4-1</p>  <p>D9112</p> <p>VC008-12064P VC008-06064P (12x1/4)</p>	<p>4-2</p>  <p>D9113</p> <p>VC008-1332-032P (1/4x1/8x1/8x1/4)x3</p>	<p>4-3</p>  <p>D9313</p> <p>VC008-13064P (13x1/8)</p>



FOR INDUSTRIAL SEWING MACHINES

<p>1-1</p>  <p>D9117A VC008-17 VC008-17 (17x1/8)</p>	<p>1-2</p>  <p>D9123A VC008-23 (23x1/8)</p>	<p>1-3</p> <p><b>SUN STAR</b></p>  <p>GP-001356-00 GP-001357-00 SC7300 (3x5.6)</p>	<p>1-4</p>		
<p>2-1</p>  <p>GP-006770-00 GP-006769-00 SC7300 (3x6.4)</p>	<p>2-2</p>	<p>2-3</p>  <p>GP-009971-00 GP-009972-00 SC7310 (3x5.6) SC7310 (3x6.4)</p>	<p>2-4</p>	<p>2-5</p>  <p>GP-012180-00 GP-012179-00 SF-7500BN (3x5.6)</p>	<p>2-6</p>
<p>3-1</p>  <p>GP-012986-00 GP-012985-00 SF-7500BN (3x6.4)</p>	<p>3-2</p>	<p>3-3</p> <p><b>YAMATO</b></p>  <p>2109000 2109001 2109067 AZ8000H-04 (0x4)</p>	<p>3-4</p>	<p>3-5</p>  <p>2109007 2109006 2109067 AZ8003H-03 (0x3)</p>	<p>3-6</p>
<p>4-1</p>  <p>2109005 2109006 2109067 AZ8003H-04 (0x4) AZ8020HY5 (2.4x5) AZ8020HY6 (2.4x6) AZ8020G (2.4x5) (2.4x6) AZ6020H (2.4x5) (2.4x6)</p>	<p>4-2</p>	<p>4-3</p>  <p>2109005 2109006 2109052 AZ-8020G (0x4)</p>	<p>4-4</p>	<p>4-5</p>  <p>2119002 2119000/2119015 AZ-8451</p>	<p>4-6</p>

FOR INDUSTRIAL SEWING MACHINES

<p>1-1</p>  <p>2109000 2109001/2109052 AZ8000G (0x4) AZ6000H (0x4) AZ8500G-A4 (3.2x4) AZ6500H-A4 (3.2x4)</p>	<p>1-2</p>	<p>1-3</p>  <p>2109050 2109051/2109052 AZ6500H-A4 (3.2x4) AZ8500H-A4 (3.2x4) AZ8500G-A4 (3.2x4)</p>	<p>1-4</p>	<p>1-5</p>  <p>3109000 3109001 VC2600-132M (2x3.2) VC2600-140M (2x4.0) VC2600-148M (2x4.8) VC2600-156M (3x5.6)</p>	<p>1-6</p>
<p>2-1</p>  <p>3109000 3106000 VC2600/VC2700</p>	<p>2-2</p>	<p>2-3</p>  <p>3109002 3109003 VC2700-164M (3x6.4)</p>	<p>2-4</p>	<p>2-5</p>  <p>3109020 3109022 3109021 VC2603-140M-11 (2x4.0) VC2703-156M-11 (3x5.6) VC2703-164M (3x6.4)</p>	<p>2-6</p>
<p>3-1</p>  <p>3119020 3119021 VC3611-156M (3x5.6) VC3611-164M (3x6.4)</p>	<p>3-2</p>  <p>3209001 3209080 VF2200-132M (2x3.2) VF2200-140M (2x4.0) VF2200-148M (2x4.8) VF2300-156M (3x5.6)</p>	<p>3-3</p>  <p>3209001 3209000 VF2400-132M (2x3.2) VF2400-140M (2x4.0) VF2400-148M (2x4.8) VF2500-156M (3x5.6)</p>	<p>3-3</p>	<p>3-3</p>	<p>3-3</p>
<p>4-1</p>  <p>3209003 3209002 VF2400</p>	<p>4-2</p>  <p>3209009 3209008 VF2403-140M-11 (2x4.0) VF2503-156M-11 (3x5.6)</p>	<p>4-3</p>  <p>3209005 3209004 VF2403-148M (2x4.8)</p>	<p>4-3</p>	<p>4-3</p>	<p>4-3</p>



FOR INDUSTRIAL SEWING MACHINES

<p><b>1-1</b></p>  <p>3209007 3209006</p> <p>VF2503 VF2303M-140M</p>	<p><b>1-2</b></p>  <p>3209065 3209064</p> <p>VF2503-21-156M (3x5.6) VF2503-21-164M (3x6.4)</p>	<p><b>1-3</b></p>  <p>3159019 3159034</p> <p>VE2713-156S-2-K4N (3x5.6)</p>	<p><b>1-4</b></p>  <p>3159037</p>
<p><b>2-1</b></p>  <p>3509004 3509005</p> <p>VG-2700-132M (2x3.2) VG-2700-140M (2x4.0) VG-2700-148M (3x4.8) VG-2700-156M (3x5.6) VG-2700-164M (3x6.4)</p>	<p><b>2-2</b></p>  <p>3159034 3159012</p> <p>VE2716-156L-2-TIN (3x5.6) VE2716-156L-TIN (3x5.6)</p>	<p><b>2-3</b></p>  <p>3109024 3109025</p> <p>VG2735 (3x5.6) (3x6.4)</p>	<p><b>2-4</b></p>  <p>3159037</p>
<p><b>3-1</b></p>  <p>3509039 3509037</p> <p>VG3721-140S1 (2X4.0)</p>	<p><b>3-2</b></p>  <p>3509036 3509037</p> <p>VG-3721-148S1 (3x4.8) VG-3721-156S1 (3x5.6)</p>	<p><b>3-3</b></p>  <p>93394 93395</p> <p>DV1250-MA (2x3.2) DV1250-MB (2x4.0) DV1250-MC (2x4.8) DW1350-MD (3x5.6)</p>	<p><b>3-4</b></p>  <p>93395</p>
<p><b>4-1</b></p>  <p>93396 93397</p> <p>DW1350 (3x6.4)</p>	<p><b>4-2</b></p>  <p>68095 68096</p> <p>FD-62-01</p>		

FOR INDUSTRIAL SEWING MACHINES

<p><b>1-1</b></p>  <p>S36562-001 S36562-001.D0.8 LT2-B875-UT LT2-B872-UT (2x1/8)</p> <p>159575-101</p> <p>LT2-B875-UT LT2-B872-UT (2x5/8)</p>	<p><b>1-2</b></p>  <p>S36564-001</p> <p>LT2-B875-UT LT2-B872-UT (2x3/16)</p> <p>101491-101</p> <p>DT6-B926 (2x3/16)</p>	<p><b>1-3</b></p>  <p>S36566-001 S36566-001.D0.8 LT2-B875-UT LT2-B872-UT (2x1/4)</p> <p>106160-101</p> <p>DT6-B927 (2x1/4)</p>	<p><b>1-4</b></p>  <p>155459-001</p> <p>LT2-B875-UT LT2-B872-UT (2x5/16)</p> <p>S40355-101</p> <p>DT6-B927 (2x3/16)</p>	<p><b>1-5</b></p>  <p>155461-001</p> <p>LT2-B875-UT LT2-B872-UT (2x3/8)</p> <p>150668-101</p> <p>DT6-B928 (2x1/4)</p>	<p><b>1-6</b></p>  <p>S09367-101</p> <p>LT2-B875-UT LT2-B872-UT (2x1/2)</p> <p>148865-201</p> <p>DT6-B928-7 (3x1/8)</p>
<p><b>2-1</b></p>  <p>150672-101</p> <p>DT6-B928-6 (3x1/8)</p>	<p><b>2-2</b></p>  <p>146884-001</p> <p>EF4-B511-01 (0x3) EF4-B511-01 (0x4) EF4-B511-01 (0x5) EF4-B511-01 (0x6)</p>	<p><b>2-3</b></p>  <p>146902-001</p> <p>EF4-B531-5 (2.2x5) EF4-B531-5 (2.2x6) EF4-B531-6 (2.2x5) EF4-B531-6 (2.2x6)</p>	<p><b>2-4</b></p>  <p>S40355-101</p> <p>DT6-B927 (2x3/16)</p> <p>146871-101</p> <p>MA4-B551-063/064 (3x3) MA4-B551-063/064 (3x4) MA4-B551-063/064 (3x5)</p>	<p><b>2-5</b></p>  <p>150668-101</p> <p>DT6-B928 (2x1/4)</p> <p>146874-101</p> <p>MA4-B551-065 (5x5)</p>	<p><b>2-6</b></p>  <p>148865-201</p> <p>DT6-B928-7 (3x1/8)</p> <p>148013-101</p> <p>MA4-B551-087 (5x5) MA4-B551-092 (5x5)</p>
<p><b>3-1</b></p>  <p>S20494-001</p> <p>S19260-001</p> <p>EF4-N11-01-4 (B) (0x4) EF4-N11-01-5 (B) (0x5)</p>	<p><b>3-2</b></p>  <p>S20494-001</p> <p>S29948-001</p> <p>EF4-N11-01-4 (C) (0x4) EF4-N11-01-5 (C) (0x5)</p>	<p><b>3-3</b></p>  <p>S20494-001</p> <p>S19271-001</p> <p>EF4-N11-07-2</p>	<p><b>3-4</b></p>  <p>S20494-001</p> <p>S19255-001</p> <p>EF-N11-01-3 (0x3)</p>	<p><b>3-5</b></p>  <p>S20494-001</p> <p>S25543-001 S19280-001</p> <p>EF4-N21-22-4 (2.2x4) EF4-N21-22-5 (2.2x5)</p>	<p><b>3-6</b></p>  <p>S20494-001</p> <p>S19287-201</p> <p>EF4-N21-27-5 (2.2x5)</p>























<p>1-1</p>  <p>S19293-001 EF4-N21-41-5 (2.2x5)</p>	<p>1-2</p>  <p>S19297-001 EF4-N21-45-5 (2.2x5)</p>	<p>1-3</p>  <p>S19313-201 MA4-N31-63-3 (3x3) MA4-N31-63-4 (3x4) MA4-N31-63-5 (3x5)</p>	<p>1-4</p>  <p>S19317-101 MA4-N31-65-5 (5x5) MA4-N31-65-6 (5x6)</p>	<p>1-5</p>  <p>S19334-001 MA4-N31-5050-55-E3W (5x5) MA4-N31-5050-56-E3W (5x6) MA4-N31-5050-57-E3W (5x7) FB-N310-5050-55-E3W (5x5) FB-N310-5050-56-E3W (5x6) FB-N310-5050-57-E3W (5x7)</p>	<p>1-6</p>  <p>S30525-001 MA4-N31-4050-55-E3W (5x5) MA4-N31-4050-56-E3W (5x6) MA4-N31-4050-57-E3W (5x7) FB-N310-4050-55-E3W (5x5) FB-N310-4050-56-E3W (5x6) FB-N310-4050-57-E3W (5x7)</p>
<p>2-1</p>  <p>144629-001 LH4-B814-2 (25 mm)</p>	<p>2-2</p>  <p>144497-001 LH4-B814-2 (25 mm)</p>	<p>JUKI</p>	<p>2-3</p>  <p>B1509-038-DB0 MH-380 (2x3/16)</p>	<p>2-4</p>  <p>B1509-038-FB0 MH-380 (2x1/4)</p>	<p>2-5</p>  <p>B1509-038-KB0 MH-380 (2x3/8)</p>
<p>3-1</p>  <p>B1509-038-BB0 MH-380 (2x1/8)</p>	<p>3-2</p>  <p>129-27760 MS-1190 (2x3/16)</p>	<p>3-3</p>  <p>B1525-241-HA0 DNU-241H</p>	<p>3-4</p>  <p>118-76364 MO-2504-OD6-300 (0x3.2)</p>	<p>3-5</p>  <p>118-76059 MO-2504-OA4-150 (0x1.6) MO-2504-OA4-150-FG (0x1.6)</p>	<p>3-6</p>  <p>118-76067 MO-2504-OA4-150 (0x1.6) MO-2504-OA4-150-FG (0x1.6)</p>
<p>4-1</p>  <p>118-76158 MO-2504-OD4-FG (3.2) MO-2504-OE4-300 (0x4.0) MO-3904-OE4 (0x4.0) MO-3904-OE4-FG (0x4.0) MO-6704-OE4-40H (0x4.0)</p>	<p>4-2</p>  <p>118-76166 MO-2504-OE4-300 (0x4.0) MO-3904-OE4 (0x4.0) MO-3904-OE4-FG (0x4.0) MO-6704-OE4-40H (0x4.0)</p>	<p>4-3</p>  <p>118-81455 MO-2504-OD4-200 (0x3.2)</p>	<p>4-4</p>  <p>118-81471 MO-2504-OD4-200 (0x3.2)</p>	<p>4-5</p>  <p>118-76356 MO-2504-OD6-300 (0x3.2)</p>	<p>4-6</p>  <p>118-76869 MO-2414N-BE6 (2x4) MO-2514-BD6 (2.0x3.2) MO-6714-BE6-20H (2x4.0) MO-6714-BE4-40H (2x4.0)</p>

























<p>1-1</p>  <p>118-77156 MO-2512-DD6-500 (3.2x3.2) MO-2512-DD6-600 (3.2x4.8)</p>	<p>1-2</p>  <p>118-77164 MO-2512-DD6-500 (3.2x3.2) MO-2512-DD6-600 (3.2x4.8)</p>	<p>1-3</p>  <p>118-79251 MO-2514-BO6-340 (2x3.2)</p>	<p>1-4</p>  <p>118-79269 MO-2514-BO6-340 (2x3.2)</p>	<p>1-5</p>  <p>118-81554 MO-2514-BD4-200 (2x3.2) MO-2514-BD4-200-FG (2x3.2)</p>	<p>1-6</p>  <p>118-81570 MO-2514-BD4-200 (2x3.2) MO-2514-BD4-200-FG (2x3.2)</p>
<p>2-1</p>  <p>118-76851 MO-2514-BD4 (2.0x3.2) MO-6714-BE6-20H (2x4.0) MO-6714-BE4-40H (2x4.0)</p>	<p>2-2</p>  <p>118-77552 MO-2516-DD4-300 (3.2x3.2) MO-2516-DF4-300 (3.2x4.8)</p>	<p>2-3</p>  <p>118-77578 MO-2516-DD4-300 (3.2x3.2) MO-2516-DF4-300 (3.2x4.8)</p>	<p>2-4</p>  <p>118-77750 MO-2516-FF6-500 (4.8x4.8)</p>	<p>2-5</p>  <p>118-77768 MO-2516-FF6-500 (4.8x4.8)</p>	<p>2-6</p>  <p>118-78055 MO-2543-FBD6-300-FG (4.8x2.0x3.2) MO-6743-ID6-40H (4.8x2x3.2)</p>
<p>3-1</p>  <p>118-78063 MO-2543-FBD6-300-FG (4.8x2.0x3.2) MO-6743-ID6-40H (4.8x2x3.2)</p>	<p>3-2</p>  <p>12466058 MO-3304E-OE4-4 (0x3) MO-3304E-OF6-50H (0x4.8)</p>	<p>3-3</p>  <p>12466157 MO-3305E-OE4-41H (0x3.4) MO-3305E-OE-L121 (0x3.4)</p>	<p>3-4</p>  <p>12466850 MO-3314E-BE6-44H (2.2x3.6) MO-3314E-BE6-G41 (2.2x3.6) MO-3314E-BE6-Q148 (2.2x3.6) MO-3314E-BE6-40H (2.2x3.6)</p>	<p>3-5</p>  <p>12466553 MO-3314E-BE6-44H (2.2x3.6) MO-3314E-BE6-G41 (2.2x3.6) MO-3314E-BE6-Q148 (2.2x3.6) MO-3314E-BE6-40H (2.2x3.6)</p>	<p>3-6</p>  <p>12466751 MO-3314E-BE6-42H (2.2x3.6) MO-3314E-BE6-S170 (2.2x3.6)</p>
<p>4-1</p>  <p>12470050 MO-3316E-DE4-40H (3x3.8) MO-3316E-DE6-40H (3x3.8)</p>	<p>4-2</p>  <p>12470357 MO-3316E-DE6-42H (3x3.8) MO-3316E-DE6-S169 (4.8x4.8)</p>	<p>4-3</p>  <p>12470159 MO-3316E-FF6-40H (4.8x4.8)</p>	<p>4-4</p>  <p>12470258 MO-3316E-FF6-60H (4.8x4.8) MO-3316E-FH6-60H (4.8x6) MO-3316E-FH6-50H (4.8x6)</p>	<p>4-5</p>  <p>12473153 MO-3343 (4.8x2.2x3.2)</p>	<p>4-6</p>  <p>121-52450 MO-3914-BE6 (2.0x4.0) MO-3914-BE6-FG (2.0x4.0)</p>











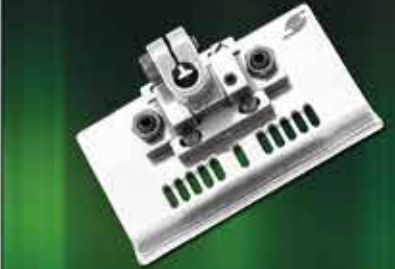

<p><b>1-1</b></p>  <p>121-52468 MO-3914-BE6 (2.0x4.0) MO-3914-BE6-FG (2.0x4.0)</p>	<p><b>1-2</b></p>  <p>121-52451 MO-3914-BE6</p>	<p><b>1-3</b></p>  <p>121-52955 MO-3916-BE (2x3.2)</p>	<p><b>1-4</b></p>  <p>121-52963 MO-3916-BE (2x3.2)</p>	<p><b>1-5</b></p>  <p>121-53755 MO-3916-DE6 (3.2x4.0) MO-3916-DE4-FG (3.2x4.0) MO-6716-DE6-40H (3.2x4.0)</p>	<p><b>1-6</b></p>  <p>121-53763 MO-3916-DE6 (3.2x4.0) MO-3916-DE4-FG (3.2x4.0) MO-6716-DE6-40H (3.2x4.0)</p>
<p><b>2-1</b></p>  <p>121-54258 MO-3916-FF6 (4.8x4.8) MO-3916-FF6-FG (4.8x4.8) MO-6716-FF6-40H (4.8x4.8)</p>	<p><b>2-2</b></p>  <p>121-54266 MO-3916-FF6 (4.8x4.8) MO-3916-FF6-FG (4.8x4.8) MO-6716-FF6-40H (4.8x4.8)</p>	<p><b>2-3</b></p>  <p>118-81257 MO-3943-FBD6-347 MO-3943-FBD6-G07 MO-3943-FBD6-Q141 (4.8x2x3.2)</p>	<p><b>2-4</b></p>  <p>118-81265 MO-3943-FBD6-347 MO-3943-FBD6-G07 MO-3943-FBD6-Q141 (4.8x2x3.2)</p>	<p><b>2-5</b></p>  <p>121-55552 MO-3914-FH6-60H (0x4.8)</p>	<p><b>2-6</b></p>  <p>121-55560 MO-3914-FH6-60H (0x4.8)</p>
<p><b>3-1</b></p>  <p>B1507-814-0A0 MO-804-OD4 (0x3.2)</p>	<p><b>3-2</b></p>  <p>135-18600 135-18659 LK-1850 (20x4.5)</p>	<p><b>3-3</b></p>  <p>135-18709</p>	<p><b>3-4</b></p>  <p>135-54308 135-54357 LK1850G (20x8-1)</p>	<p><b>3-5</b></p>  <p>135-54407</p>	
<p><b>4-1</b></p>  <p>135-72003 LK1900</p>	<p><b>4-2</b></p>  <p>135-71906 135-71955 LK1900A</p>	<p><b>4-3</b></p>  <p>135-48201 LK1900 (27x5)</p>	<p><b>4-4</b></p>  <p>135-48102 135-48151 LK1900A (27x5)</p>		

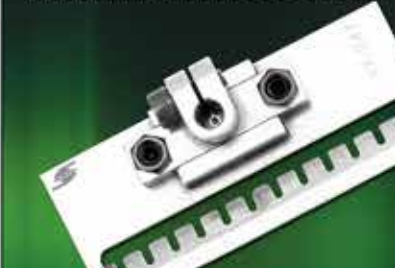





















<p><b>1-1</b></p>  <p>D1511-771-KA0-A</p>	<p><b>1-2</b></p>  <p>D1511-772-KA0-A</p>	<p><b>1-3</b></p>  <p>D1511-772-KA0</p>	<p><b>1-4</b></p>  <p>D1511-773-KA0-A</p>	<p><b>1-5</b></p>  <p>400-08646</p>
<p><b>TE424</b></p> 	<p><b>TE424</b></p> 	<p><b>TE424</b></p> 	<p><b>TE424</b></p> 	<p><b>TE424</b></p> 
<p><b>B1552-781-000A</b></p> 	<p><b>B1552-782-000</b></p> 	<p><b>D1508-772-K00</b></p> 	<p><b>B1552-783-000</b></p> 	<p><b>400-08658</b></p> 
<p><b>B1552-781-0A0-A</b> LBH-781 (16 mm)</p> 	<p><b>B1552-782-0A0-A</b> LBH-782 (25 mm)</p> 	<p><b>B1552-782-0A0-A (K)</b> LBH-782-K (25 mm)</p> 	<p><b>B1552-783-0A0-A</b> LBH-783 (30 mm)</p> 	<p><b>PE040</b> LBH-1790</p> 



<p>1-1</p>  <p>57-3010-1 UK2004S-01M (0x4)</p>	<p>1-2</p>  <p>57-3210-1 UK2004S-20F (0x1.5)</p>	<p>1-3</p>  <p>57-3110-1 UK2005S-10M (0x3) UK2005S-10M (0x4)</p>	<p>1-4</p>  <p>57-3310-1 UK2014H-01M (2x3) UK2014H-01M (2x4)</p>	<p>1-5</p>  <p>57-3410-1 UK2014H-40M (2x4) UK2014H-40M (2x5)</p>	<p>1-6</p>  <p>57-3020-1 UK2116S-01M (3x4)</p>
<p>2-1</p>  <p>57-3120-1 UK2116S-02M (3x4)</p>	<p>2-2</p>  <p>57-3320-1 UK2116H-03X (5x5)</p>	<p>2-3</p>  <p>57-3220-1 UK2116S-01H (5x5)</p>	<p>2-4</p>  <p>57-3420-1 UK2116S-30M (5x5)</p>	<p>2-5</p>  <p>57-3520-1 UK2116S-30M (5x5)</p>	<p>2-6</p>  <p>57-3620-1 UK2143H-90M</p>
<p>3-1</p>  <p>17-7680-1 WX8800 (3x5.6)</p>	<p>3-2</p>  <p>17-7690-1 WX8800 (3x6.4)</p>	<p>3-3</p>  <p>17-3010-1 PX302-4W</p>	<p>3-4</p>  <p>17-3610-1 PX302-4W</p>	<p>3-5</p>  <p>17-5630-1 LX-5802M (2x1/4)</p>	<p>3-6</p>  <p>17-7620-1 B2000 (2x1/4)</p>
<p>4-1</p>  <p>17-760-1 DVK1702BK (2x1/4)</p>	<p>4-2</p>  <p>17-5810-1 DLR1508P-E (4x1/4x1x1/4)</p>	<p>4-3</p>  <p>17-3750-1 DFB1404P (4x3/4) 17-3710-1 DFB1404P (4x1)</p>	<p>4-4</p>  <p>17-3890-1 DFB1406P (6x3/16) 17-3900-1 DFB1406P (6x1/4)</p>	<p>4-5</p>  <p>17-3930-1 DFB1408 (8x1/4)</p>	<p>4-6</p>  <p>17-D 1/8x11 1404P (11x1/8)</p>

<p>1-1</p>  <p>17-11T 1404P (11x1/8T)</p>	<p>1-2</p>  <p>17-3960-1 DFB-1412P (12x1/4)</p>  <p>17-3970-1 DFB-1412P (12x3/16)</p>	<p>1-3</p>  <p>17-4780-1 1404P (12x1/8)</p>
<p>2-1</p>  <p>17-0460-1 DFB1412PSSM (12x3/16)</p>	<p>2-2</p>  <p>17-0470-1 DFB1412PSSM (12x1/4)</p>	<p>2-3</p>  <p>17-D 1/8x17 KS1404P (17x1/8)</p>  <p>17-17T KS1404P (17x1/8T)</p>
<p>3-1</p>  <p>10-0250-0 1425P (25x1/4)</p>		
<p>4-1</p>  <p>10-0300-0 1433 (33x3/16)</p>		



<p>1-1</p>  <p>PF60SC32 SH6005-CS2-M16 (3.2x3.2)</p>	<p>1-2</p>  <p>PF634D03 SH6034-D03-M45 (2x4.8)</p>	<p>1-3</p>  <p>5220PF42561 CT9042 (3x5.6) 5220PF42641 CT9042 (3x6.4)</p>	<p>1-4</p>  <p>5222PF85560 CT8556 (3x5.6) 5222PF85641 CT8556 (3x6.4)</p>	<p>1-5</p>  <p>5222PF85400 CTD-9085 (2x4.0) 5222PF85480 CTD-9085 (2x4.8)</p>	<p>1-6</p>  <p>5222PF85560 CTD-9085 (3x5.6) 5222PF85640 CTD-9085 (3x6.4)</p>
<p>2-1</p>  <p>5222PFL1400 CTD-9311 (2x4.0)</p>	<p>2-2</p>  <p>5222PFL1480 CTD-9311 (2x4.8)</p>	<p>2-3</p>  <p>5222PFL1560 CTD-9311 (3x5.6)</p>	<p>2-4</p>  <p>5222PFL1640 CTD-9311 (3x6.4)</p>	<p>PEGASUS</p>	
<p>3-1</p>  <p>208508 M732-48 (3x4)</p>	<p>3-2</p>  <p>208649 L32-359 (3x2x4) M732-354 (3x2x4) M732-355 (3x2x4)</p>	<p>3-3</p>  <p>208501 L32-34 (3x3) (3x4) (3x5) M732-36 (3x3) (3x4) (3x5)</p>	<p>3-4</p>  <p>208504 L32-38 (3x3) (3x4) (3x5) M732-38 (3x3) (3x4) (3x5)</p>	<p>3-5</p>  <p>208502 L32-70 (5x5) / (5x6) M732-70 (5x5) / (5x6)</p>	<p>3-6</p>  <p>208506 208955 L32-86 (5x5)/(5x6) M732-86 (5x5)/(5x6)</p>
<p>4-1</p>  <p>208506S L32-86 (5x6)</p>	<p>4-2</p>  <p>208525 208525 201152E/201155C L52-01 (0x4) M752-01 (0x4)</p>	<p>4-3</p>  <p>208525 201473B/301433 M752-180 (0x4)</p>	<p>4-4</p>  <p>208525 201230C/201224B L52-17 (0x4) M752-17 (0x4)</p>	<p>4-5</p>  <p>208525 208730/208731 208730/208732 L52-13 (2x3)/(2x4) M752-13 (2x3)/(2x4)</p>	<p>4-6</p>  <p>208525 205253/209734 M752-181 (2x4)</p>















<p>1-1</p>  <p>208525 205253/201310A L52-51 (2x4)</p>	<p>1-2</p>  <p>208525 201230C/201396B L52-11 (2x4)</p>	<p>1-3</p>  <p>208525 201230C/205525 M752-16S1 (0x1.5) M752-16S2 (0x1.5)</p>	<p>1-4</p>  <p>208525 201230C/208050A M752-23B (2.5x4.5)</p>	<p>1-5</p>  <p>208525 212182/210371 M752-53A (0x4) M752-54A (0x4)</p>	<p>1-6</p>  <p>208525 212182/201310A M752-55A (2x4)</p>
<p>2-1</p>  <p>274018-92B0 201152E0/201155C0 M852-01 (0x4)</p>	<p>2-2</p>  <p>274018-92B0 201230C0/2055250 M852-16S2 (0x1.5)</p>	<p>2-3</p>  <p>274018-92B0 201230C0/2103710 M852-17 (0x4)</p>	<p>2-4</p>  <p>274018-92B0 2087300/2087321 M852-13 (2x4) M852-13 (2x5)</p>	<p>2-5</p>  <p>2771180 M832-3B (3x4)</p>	<p>2-6</p>  <p>277118A0 M832-85S (3x2x4)</p>
<p>3-1</p>  <p>2771190 M832-70 (5x5)</p>	<p>3-2</p>  <p>2771220 M832-86 (5x5)</p>	<p>3-3</p>  <p>274018-92B 201230C/210370 201230C/210371 EX5204-01/223K (0x3) EX5204-01/223K (0x4) EX5204-02/223K (0x3) EX5204-02/223K (0x4)</p>	<p>3-4</p>  <p>274018-92B 202799/210371 202799/210372 EX5203-22/223K (0x5) EX5203-22/223K (0x6)</p>	<p>3-5</p>  <p>274018-92B 201152E/277115 201152E/277103 EX5203-12/233K (0x3) EX5203-12/233K (0x4) EX5205-12/233K (0x3) EX5205-12/233K (0x4)</p>	<p>3-6</p>  <p>274018-92B 202799/205525 EX5204-32R2/223L(K) (0x1.5) EX5204-32R2/223(K) (0x1.5)</p>
<p>4-1</p>  <p>274018-92B 201230C/210503 201230C/210371 201230C/210374 EX5212-02/333K(2x3) EX5212-02/333K(2x4) EX5212-02/333K(2x5)</p>	<p>4-2</p>  <p>274018-92B 277112/208651 EX5214-53/333K(2x4) EX5214-53/333K(2x5) EX5214-53C3/333K(2x4) EX5214-53C3/333K(2x5)</p>	<p>4-3</p>  <p>277118 EX3216-02/223K(3x4) EX3216-02/223K(3x5) EX3216-03/233K(3x4) EX3216-03/233K(3x5)</p>	<p>4-4</p>  <p>277119 EX3216-03/233K(5x5) EX3216-03/233K(5x6)</p>	<p>4-5</p>  <p>277122 EX3215-04/435 (5x5) EX3215-04/435 (5x6) EX3216-04/435 (5x5) EX3216-04/435 (5x6)</p>	<p>4-6</p>  <p>277149-400 EXT5204-02/233(K) (0x4)</p>

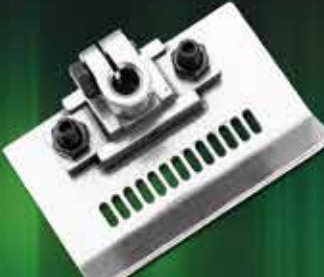
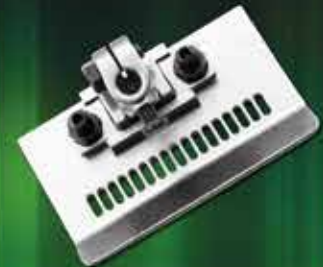

<p>1-1</p>  <p>277151-400</p> <p>EXT5214-43/333(K) (2x4)</p>	<p>1-2</p>  <p>277153-400</p> <p>EXT3215-02/233(K) (3x4)</p>	<p>1-3</p>  <p>257460-32 257460-40 257460-48</p> <p>WS61/WS62-01-CB/ WS62-01-CC/W664-01-CB (2x3.2) (2x4.0) (2x4.8)</p>	<p>1-4</p>  <p>257461-48 257461-56 257461-64</p> <p>WS61/WS62-01-CB/ WS62-01-CC/W664-01-CB (3x4.8) (3x5.6) (3x6.4)</p>	<p>1-5</p>  <p>257468-48 257468-56 257468-64</p> <p>WS61-03DB/WS62-03DB /W664-03FB (3x4.8) (3x5.6) (3x6.4)</p>	<p>1-6</p>  <p>257491-60</p> <p>WS61 (4x6) WS62-01DB (4x6)</p>
<p>2-1</p>  <p>257317A32</p> <p>WS61 (2x3.2) WS62-02BB (2x3.2) WS62-02BC (2x3.2) W664-02BB (2x3.2)</p>	<p>2-2</p>  <p>257350-32</p> <p>WS62-02HB(2x3.2)</p>	<p>2-3</p>  <p>257318A40 257318A48</p> <p>WS61/WS62-02BB /WS62-02BC (2x4.0) (2x4.8)</p>	<p>2-4</p>  <p>257321A56 257321A64</p> <p>WS61/WS62-02-BB WS62-02-BC/W664-02BB (3x5.6) (3x6.4)</p>	<p>2-5</p>  <p>257327A32</p> <p>WS62-05 (2x3.2)</p>	<p>2-6</p>  <p>257330A48</p> <p>WS61-05BB (3x4.8)</p>
<p>3-1</p>  <p>257331A56 257331A64</p> <p>WS62-05BB (3x5.6) WS62-05BB (3x6.4)</p>	<p>3-2</p>  <p>257485-40 257485-48</p> <p>W664-34-AB (2x4.0) W664-34-AB (2x4.8)</p>	<p>3-3</p>  <p>257486-56 257486-64</p> <p>W664-35BB (3x5.6) W664-35BB (3x6.4)</p>	<p>3-4</p>  <p>257499-3200</p> <p>WS62-02DB (2x3.2)</p>	<p>3-5</p>  <p>3Q003903560</p> <p>W2664-35A (3x5.6) W2664-35B (3x5.6)</p>	<p>3-6</p>  <p>3Q003903640</p> <p>W2664-35A (3x5.6) W2664-35B (3x5.6)</p>
<p>4-1</p>  <p>P101/F371</p> <p>P101-3 737-504M2 (0x4)</p>	<p>4-2</p>  <p>P101/F374</p> <p>P101-4 747-514M2 (2x4)</p>	<p>4-3</p>  <p>P103/F371</p> <p>P103-3 737-504M2 (0x4)</p>	<p>4-4</p>  <p>P103/F374</p> <p>P103-4 737-504M2 (2x4)</p>	<p>4-5</p>  <p>P152D/F155</p> <p>P152D-3 737-505F1-03 (0x3) (0x4)</p>	<p>4-6</p>  <p>P2765-A P2766-A P2767-A</p> <p>C007JD-W811/822 (3x4.8) (3x5.6) (3x6.4)</p>

<p>1-1</p>  <p>P152D/F525</p> <p>P152D-A 737-504M1-15 (0x4)</p>	<p>1-2</p>  <p>P975/F380</p> <p>P975-3 M737-514M5 (2x4)</p>	<p>1-3</p>  <p>P975/F381</p> <p>P975-4 M747-514M5 (2x4)</p>	<p>1-4</p>  <p>P253E/F371</p> <p>P253E-3 737-504M2-04 (0x4)</p>	<p>1-5</p>  <p>P253E/F374</p> <p>P253E-4 747-512M1-24 (2x4) 747-512M1-24 (2x5)</p>	<p>1-6</p>  <p>P254G/F504G</p> <p>P254G-4 747-514M2 24TG-B (2x4)</p>
<p>2-1</p>  <p>P253E/F525</p> <p>P253E-5 747F-512M1 (0x3)</p>	<p>2-2</p>  <p>P502-A</p> <p>757-516M2-55 (5x5)</p>	<p>2-3</p>  <p>P504-A</p> <p>757-516M2-35 (3x5)</p>	<p>2-4</p>  <p>P955-A</p> <p>757-56 (5x6)</p>	<p>2-5</p>  <p>P0024-A</p> <p>C007E-W122/CH (2x4.0) F007E-W122/UTG (2x4.0)</p>	<p>2-6</p>  <p>P0025-A</p> <p>C007-W122/CH (2x4.8) F007E-W122/UTG (2x4.8)</p>
<p>3-1</p>  <p>P0226-A</p> <p>F007E-W162-356 (3x5.6)</p>	<p>3-2</p>  <p>P0227-A</p> <p>F007E-W162-364CCTG (3x6.4)</p>	<p>3-3</p>  <p>P1406-A</p> <p>C007E-W322/CE (3x5.6) C007E-W332/CD (3x5.6)</p>	<p>3-4</p>  <p>P0216-A P0217-A</p> <p>C007E-W122/CH (3x5.6) C007E-W122/CH (3x6.4) F007E-W222/FQ (3x5.6) F007E-W222/FQ (3x6.4)</p>	<p>3-5</p>  <p>P2116-A P2117-A</p> <p>C007E-W222/FQ (3x5.6) F007E-W222/FQ (3x6.4)</p>	<p>3-6</p>  <p>P2408-A</p> <p>F007E-W922/FW (4x6)</p>
<p>4-1</p>  <p>P2436-A</p> <p>F007/C007K (3x5.6)</p>	<p>4-2</p>  <p>P2438Q-A</p> <p>F007 (4x6)</p>	<p>4-3</p>  <p>P1814-A</p> <p>F007-W222 (2x4.0)</p>	<p>4-4</p>  <p>P2446-A P2447-A</p> <p>C007JD-W121/CH (3x5.6) (3x6.4)</p>	<p>4-5</p>  <p>P2457-A</p> <p>C007JD-W322/CC(3x6.4)</p>	<p>4-6</p>  <p>P2765-A P2766-A P2767-A</p> <p>C007JD-W811/822 (3x4.8) (3x5.6) (3x6.4)</p>















<p>1-1</p>  <p>P0416-A C007E-UT22/CH/UTQ (2x5.6) (3x6.4)</p>	<p>1-2</p>  <p>P1815-A F007-W222 (2x4.8)</p>	<p>1-3</p>  <p>P3816R-A P3817-A C007J-W522 (3x5.6) (3x6.4)</p>	<p>1-4</p>  <p>P9104-A VC008-04085P (4Nx1)</p>	<p>1-5</p>  <p>P9512D-A VC008-06064P (6Nx1/4)</p>	
<p>2-1</p>  <p>P9412D-A VC008-06048P (6Nx3/16)</p>	<p>2-2</p>  <p>P9108-A VC008-08064P (8Nx1/4)</p>	<p>2-3</p>  <p>P9112D-A VC008-12064P (12Nx1/4)</p>			
<p>3-1</p>  <p>P9012D-A VC008-12048P (12Nx3/16)</p>	<p>3-2</p>  <p>P9113D-A VC008-1332-032P (1/4x1/8x1/8x1/4)x3</p>	<p>3-3</p>  <p>P9313-A VC008-13064P (13x1/8)</p>	<p>3-4</p>  <p>P9117-A VC008-17 (17x1/8)</p>		
<p>4-1</p>  <p>P9123-A VC008-23 (23x1/8)</p>	<p><b>SUN STAR</b></p>	<p>4-2</p>  <p>AS-002970-00 AS-003073-00 SC7310-156L (3x5.6) SC7310-156L (3x5.6)</p>	<p>4-3</p>  <p>AS-000288-00 AS-001705-00 SC7500-156M (3x5.6) SC7500-164M (3x6.4)</p>	<p>4-4</p>  <p>AS-003712-00 AS-003713-00 SF-7500BN (3x5.6) SF-7500BN (3x6.4)</p>	

<p>1-1</p>  <p>2107032 AZ8000H-04 (0x4)</p>	<p>1-2</p>  <p>2157086 AZ6000H (0x4) AZ8000G (0x4)</p>	<p>1-3</p>  <p>2107300 AZ8000H-03 (0x3)</p>	<p>1-4</p>  <p>2107301 AZ8003H-04 (0x4)</p>	<p>1-5</p>  <p>2107310 2107311 AZ8020H-Y5 (2.4x5) AZ8020H-Y6 (2.4x6)</p>	<p>1-6</p>  <p>2107308 2107309 AZ8020H-Y5 (2.4x5) AZ8020H-Y6 (2.4x6)</p>
<p>2-1</p>  <p>2157057 2157058 AZ8020G (2.4x5)/(2.4x6) AZ6020H (2.4x5)/(2.4x6)</p>	<p>2-2</p>  <p>2157116 2157118 AZ8020G (2.4x5)/(2.4x6) AZ6020H (2.4x5)/(2.4x6)</p>	<p>2-3</p>  <p>2107100 AZ8500H-A4 (3.2x4)</p>	<p>2-4</p>  <p>2107102 AZ8500H-CS (5x5)</p>	<p>2-5</p>  <p>2157310 AZ8500G-A4 (3.2x4) AZ6500H-A4 (3.2x4)</p>	<p>2-6</p>  <p>2157315 AZ8500G-CS (5x5) AZ6500H-CS (5x5)</p>
<p>3-1</p>  <p>26135 ZF-125</p>	<p>3-2</p>  <p>37496 DCY104 / DCY114</p>	<p>3-3</p>  <p>95580 95581 95582 VF2400-132M (2x3.2) VF2400-140M (2x4.0) VF2400-148M (2x4.8)</p>	<p>3-4</p>  <p>95587 VF2500-156M (3x5.6)</p>	<p>3-5</p>  <p>95238 VF2403-140M-11 (2x4.0) VC2603-140M-11 (2x5.0)</p>	<p>3-6</p>  <p>94217 VF2403-148M (2x4.8)</p>
<p>4-1</p>  <p>3207156 3207157 VF2503-21-156M (3x5.6) VF2503-21-164M (3x6.4)</p>	<p>4-2</p>  <p>63318 63319 63320 VC2600-132M (2x3.2) VC2600-140M (2x4.0) VC2600-148M (2x4.8)</p>	<p>4-3</p>  <p>64041-N VF2300-156M (3x5.6) VC2700-15L (3x5.6)</p>	<p>4-4</p>  <p>64042-N VC2700-164 (3x6.4) VF2300-164 (3x6.4)</p>	<p>4-5</p>  <p>95089 94909 VC2703-156M-11 (3x5.6) VC2703-164M (3x6.4)</p>	<p>4-6</p>  <p>3507000-N VG2700-132M (2x3.2)</p>

























FOR INDUSTRIAL SEWING MACHINES















<p>1-1</p>  <p>3507002-N VG2700-140M (2x4.0)</p>	<p>1-2</p>  <p>3507060 VG3721-140S (2x4.0)</p>	<p>1-3</p>  <p>3507050-N VG2700-148M (3x4.8)</p>	<p>1-4</p>  <p>3507052-N VE2713-156S-2-K4N (3x5.6) VE2713-156L-2-TIN (3x5.6) VE2713-156-TIN (3x5.6) VG2700-156M (3x5.6)</p>	<p>1-5</p>  <p>3507054-N VG2700-164M (3x6.4)</p>	<p>1-6</p>  <p>3117124 3117126 VC3611-156M (3x5.6) VC3611-164M (3x6.4) VG3711 (3x5.6) VG3711 (3x6.4)</p>	
<p>2-1</p>  <p>3507108 3507111 VG2735 (3x5.6) (3x6.4)</p>	<p>2-2</p>  <p>6507003 VT1500 (3x5.6)</p>	<p>2-3</p>  <p>3027092 FD-62G-12MR (5.2)</p>	<p>2-4</p>  <p>3027140 FD-62G-12MR (5.2)</p>	<p>2-5</p>  <p>3507064 VG3721-148S1 (3x4.8)</p>	<p>2-6</p>  <p>3107273 VG3721-156S1 (3x5.6)</p>	<p>2-7</p>  <p>3107274 VG3721 (3x6.4)</p>

FOR INDUSTRIAL SEWING MACHINES























<p>1-1</p>  <p>146487-001 MA4-B551-061 (2x3) MA4-B551-062 (2x3)</p>	<p>1-2</p>  <p>146489-001 MA4-551-063 (3x3) MA4-551-063 (3x4) MA4-551-063 (3x5)</p>	<p>1-3</p>  <p>146491-001 MA4-B551-065 (5x5) MA4-B551-087 (5x5) MA4-B551-092 (5x5)</p>	<p>1-4</p>  <p>146773-001 EF4-B531-5 (2.2x5) EF4-B531-5 (2.2x6)</p>	<p>1-5</p>  <p>S20398-001 EF4-N21-22-4 (2.2x4) EF4-N21-22-5 (2.2x5)</p>	<p>1-6</p>  <p>S02404-001 MA4-N31-63-3 (3x3) MA4-N31-63-4 (3x4) MA4-N31-63-5 (3x5)</p>	
<p>2-1</p>  <p>S20406-001 MA4-N31-65-5 (5x5) MA4-N31-65-6 (5x6)</p>	<p>2-2</p>  <p>S21104-001 MA4-N31-5050-55-E3W (5x5) MA4-N31-5050-56-E3W (5x6) MA4-N31-5050-57-E3W (5x7) FB-N310-5050-55-E3W (5x5) FB-N310-5050-56-E3W (5x6) FB-N310-5050-57-E3W (5x7)</p>	<p>2-3</p>  <p>183954-001 DT6-B927-8 (3/16)</p>	<p>2-4</p>  <p>183978-001 DT6-B927 (1/4) DT6-B928 (1/4)</p>	<p>2-5</p>  <p>181716-001 DT6-6926-6 (2x3.2) DT6-928-7 (2x3.2) DT6-928-6 (2x3.2)</p>	<p>2-6</p>  <p>181722-001 DT-B928-6 (2x4.8) DT6-B928-8 (2x4.8)</p>	
<p>3-1</p>  <p>S08709-001 FD4-B272-011-6 (3x4.8) FD4-B272-021-6 (3x4.8)</p>	<p>3-2</p>  <p>S08711-001 FD4-B272-011-7 (3x5.6) FD4-B272-021-7 (3x5.6)</p>	<p>3-3</p>  <p>S08713-001 FD4-B272-011-8 (3x6.4) FD4-B272-021-8 (3x6.4)</p>	<p><b>JUKI</b></p>		<p>3-4</p>  <p>118-69005 M2504-OA4-150 M2504-OD4 M2504-OD4-FG (3.2) M2504-OD4-200 (3.2)</p>	<p>3-5</p>  <p>118-69658 MO-2414N-BF-E6 (2x4) MO-2514-BD4 (2x3.2)</p>
<p>4-1</p>  <p>118-69955 MO-2512 (3.2x3.2)</p>	<p>4-2</p>  <p>118-70359 MO-2516-DD4300 (3.2x3.2) MO-2516-DF4-300 (3.2x4.8)</p>	<p>4-3</p>  <p>118-70458 MO-2516-FF6-500 (4.8x4.8)</p>	<p>4-4</p>  <p>118-70854 MO-2543-FBD6-300-FG (4.8x2.0x3.2)</p>	<p>4-5</p>  <p>124-65001 MO-3304E-OE4-40H (0x3.6) MO-3304E-OF6-50H (0x4.8) MO-3304E-DE4-40H (0x3.1)</p>	<p>4-6</p>  <p>124-65100 MO-3314E-BE6-44H G41/Q148 (2.2x3.6) MO-3314E-BE6-40H (2.2x3.6)</p>	

























<p>1-1</p>  <p>124-65407</p> <p>MO-3316E-DE4-40H (3x3.8) MO-3316E-DE6-40H (3x3.8)</p>	<p>1-2</p>  <p>124-65506</p> <p>MO-3316E-FF6-40H (4.8x4.8) MO-3316E-FF6-60H (4.8x4.8)</p>	<p>1-3</p>  <p>124-65605</p> <p>MO-3343 (4.8x2.2x3.2)</p>	<p>1-4</p>  <p>121-48607</p> <p>MO-3904</p>	<p>1-5</p>  <p>121-48706</p> <p>MO-3914 (2x2.0)</p>	<p>1-6</p>  <p>121-49803</p> <p>MO-3916 (2x3.2)</p>
<p>2-1</p>  <p>121-50306</p> <p>MO-3916 (2x4.8)</p>	<p>2-2</p>  <p>121-50603</p> <p>MO-3943 (2x2x4.8)</p>	<p>2-3</p>  <p>B1406-019-BA0</p> <p>MH-380-1/8 (2x1/8)</p>	<p>2-4</p>  <p>B1406-019-DA0</p> <p>MH-380-3/16 (2x3/6)</p>	<p>2-5</p>  <p>B1420-714-B00</p> <p>MO-804-OD4 (0x3.2)</p>	<p>2-6</p>  <p>B1420-716-D00</p> <p>MO-816</p>
<p>3-1</p>  <p>B1406-019-FA0</p> <p>MH-380-1/4 (2x1/4)</p>	<p>3-2</p>  <p>B1406-038-KA0</p> <p>MH-380-3/8 (2x3/8)</p>	<p>3-3</p>  <p>B1409-890-GA0</p> <p>MF-890-GEM (3x5.6)</p>	<p>3-4</p>  <p>B1409-890-HA0</p> <p>MF-890HBM (3x6.4) MF-890HEM (3x6.4)</p>	<p>3-5</p>  <p>129-25954</p> <p>MS-1190 (3x3/16) MS-1190M (2x3/16)</p>	<p><b>KANSAI SPECIAL</b></p>
<p>4-1</p>  <p>12-2200-1</p> <p>1702 (2x6.4)</p>	<p>4-2</p>  <p>12-2290-1</p> <p>B2000 B2000C</p>	<p>4-3</p>  <p>12-3150-1</p> <p>PX302-4W</p>	<p>4-4</p>  <p>12-8010-1</p> <p>V7003D-7/32" (3x5.6) V8003C-7/32" (3x5.6) V7003F-7/32" (3x5.6)</p>	<p>4-5</p>  <p>12-8020-1</p> <p>V7003D-1/4" (3x5.6) V8003C-1/4" (3x5.6) V7003DE-1/4" (3x5.6)</p>	<p>4-6</p>  <p>12-8290-1</p> <p>WX/DW (3x1/4) WX8800 (2x5.6)</p>

<p>1-1</p>  <p>57-504</p> <p>UK-1165-01M (3x4) UK-1165-02M (3x5) UK-1165-30M (3x4)</p>	<p>1-2</p>  <p>57-505</p> <p>UK-1014H-01M (2x4) UK-1014H-01M (2x5)</p>	<p>1-3</p>  <p>57-506</p> <p>UK-11165-01H (5x5)</p>	<p>1-4</p>  <p>12-4180-1 1404P (4x3/4) 12-4210-1 1404P (4x1)</p>	<p>1-5</p>  <p>12-4420-1 1406P (6x1/4) 12-4430-1 1406P (6x3/16)</p>	<p>1-6</p>  <p>12-5810-1</p> <p>DLR1508P-E (1/4x1x1/4)</p>
<p>2-1</p>  <p>12-D 1/8x11 KS1404P 1/8x11</p>	<p>2-2</p>  <p>12-11T KS1404P (11x1/8)</p>	<p>2-3</p>  <p>12-4980-1 12-4990-1 DFB1412P (12x1/4) DFB1412P (12x3/16)</p>			
<p>3-1</p>  <p>12-4780-1 1404P (12x1/8) 12-4490-1.A 1404P (12x3/16)</p>	<p>3-2</p>  <p>12-D 1/8x17 KS1404P (17x1/8)</p>	<p>3-3</p>  <p>17-17T KS1404P (17x1/8T)</p>			
<p>4-1</p>  <p>12-0250-1 1425PL- (25x1/4)</p>	<p>4-2</p>  <p>12-0330-1 1433PL- (33x3/16)</p>				



<p>1-1</p>  <p>NC603033</p> <p>SH6002-032-M02 SH6003-032-M04 SH6043-032-M04</p>	<p>1-2</p>  <p>NC604022</p> <p>SH6004-A32-M14 SH6004-A42-M14 SH6004-A33-M14</p>	<p>1-3</p>  <p>NC605032 NC605048</p> <p>SHF6005-C32-M16 (2x5) SHF6005-D53-L16 (0x5)</p>	<p>1-4</p>  <p>5220NC00400 5220NC00480</p> <p>CTD-9085 (2x4.0) CTD-9311 (2x4.8) CT-9042</p>	<p>1-5</p>  <p>5220NC00561 5220NC00641</p> <p>CTD-9058 (3x5.6) CTD-9311 (3x6.4) CT-9042</p>	<p>PEGASUS</p>
<p>2-1</p>  <p>209670</p> <p>M752-180 (0x4)</p>	<p>2-2</p>  <p>208905</p> <p>L52-13 (2x3) (2x4) M752-13 (2x3) (2x4)</p>	<p>2-3</p>  <p>208909</p> <p>L32-31 (3x3) (3x4) L32-34 (3x3) (3x4) L32-38 (3x3) (3x4) (3x5)</p>	<p>2-4</p>  <p>208910</p> <p>L32-70 (5x5) (5x6) L32-86 (5x5) (5x6)</p>	<p>2-5</p>  <p>208914</p> <p>L32</p>	<p>2-6</p>  <p>208965</p> <p>L32-359 (3x2x4)</p>
<p>3-1</p>  <p>209670-92</p> <p>L52-01 (0x4) L52-17 (0x4) M752-01 (0x4) M752-17 (0x4)</p>	<p>3-2</p>  <p>208905A92</p> <p>M752-181 (2x4)</p>	<p>3-3</p>  <p>208906A92</p> <p>M752-238 (2.5x4.5)</p>	<p>3-4</p>  <p>208909B92</p> <p>M752-238 (2.5x4.5)</p>	<p>3-5</p>  <p>208910B92</p> <p>M732-70 (5x5) (5x6) M732-86 (5x5) (5x6)</p>	<p>3-6</p>  <p>208965B92</p> <p>M732-354 (3x2x4) M732-355 (3x2x4)</p>
<p>4-1</p>  <p>179630-92</p> <p>EX5204-01/223K (0x3) (0x4) EX5204-22/223K (0x3) (0x4) (0x5)</p>	<p>4-2</p>  <p>277022-92</p> <p>EX5212-02/333K (2x3) (2x4) (2x5)</p>	<p>4-3</p>  <p>277027-92</p> <p>EX3216-02/223K (3x4) (3x5) EX3216-03/233K (3x4) (3x5)</p>	<p>4-4</p>  <p>277028-92</p> <p>EX3216-03/233K (5x5) (5x6)</p>	<p>4-5</p>  <p>277029-92</p> <p>EX3216-04/435K (5x5) (5x6)</p>	<p>4-6</p>  <p>277031-92</p> <p>EX3244-03/333K (5x2x4)</p>

<p>1-1</p>  <p>179630-920</p> <p>M852-01 (0x4) M852-1652 (0x1.5) M852-17 (0x4)</p>	<p>1-2</p>  <p>277022-920</p> <p>M852-13 (2x4) (2x5)</p>	<p>1-3</p>  <p>277027-921</p> <p>M832-38 (3x4)</p>	<p>1-4</p>  <p>277029-920</p> <p>M832-70 (5x5) M832-86 (5x5)</p>	<p>1-5</p>  <p>257500-40 257500-48</p> <p>W500 (2x4.0) W600 (2x4.8)</p>	<p>1-6</p>  <p>257501-64 257501-56</p> <p>W500 (3x5.6) W600 (3x6.4)</p>
<p>2-1</p>  <p>257542-561 257542-641</p> <p>W1612-32B (3x5.6) W1612-32B (3x6.4)</p>	<p>2-2</p>  <p>236631-56</p> <p>FW603AF</p>	<p>2-3</p>  <p>257517-32</p> <p>W562-02BB/BC W664-02BB (2x3.2)</p>	<p>2-4</p>  <p>257517-40</p> <p>W562-02BB/BC W664-02BB (2x4.0)</p>	<p>2-5</p>  <p>257517-48</p> <p>W562-02BB/BC W664-02BB (2x4.8)</p>	<p>2-6</p>  <p>257518-48</p> <p>W562-02BB/BC W664-02BB (3x4.8)</p>
<p>3-1</p>  <p>257518-56</p> <p>W562-02BB/BC W664-02BB (3x5.6)</p>	<p>3-2</p>  <p>257518-64</p> <p>W562-02BB/BC W664-02BB (3x6.4)</p>	<p>3-3</p>  <p>91-164726-93/003</p>	<p>3-4</p>  <p>91-164727-X4</p>	<p>3-5</p>  <p>91-710004-04/002</p>	<p>PFAFF</p>
<p>4-1</p>  <p>91-710004-04</p>	<p>4-2</p>  <p>91-710004-04/005</p>	<p>4-3</p>  <p>91-710004-04/006</p>	<p>4-4</p>  <p>KG131</p> <p>737-504M2 737-505F1 737-504M1 747-514M2 747-514H4 (0x3) (0x4)</p>	<p>4-5</p>  <p>KG142</p> <p>747-512M1 747-514M2 747-514H4 (0x4) (2x4) (2x5)</p>	<p>SIRUBA</p>







<p>1-1</p>  <p>KG153</p> <p>757-516M2 757-516H4 (3x5)</p>	<p>1-2</p>  <p>KG155</p> <p>757-516M2 757-516H4 757-516x2 (5x5) (5x6)</p>	<p>1-3</p>  <p>KG333</p> <p>767-516M2 (3x2x4)</p>	<p>1-4</p>  <p>KG355</p> <p>767-516M2 (5x2x4)</p>	<p>1-5</p>  <p>KG231K-E</p> <p>737K-504M1 737K-504M2 (0x3) (0x4)</p>	<p>1-6</p>  <p>KG242K-E</p> <p>747-512M1 747-514M2 (2x4)</p>
<p>2-1</p>  <p>KG253K-E</p> <p>757K (5x5) (5x6)</p>	<p>2-2</p>  <p>KG255K-E</p> <p>757K-516M2 (5x5)</p>	<p>2-3</p>  <p>KG433K-E</p> <p>767K-516M2 (3x2x4)</p>	<p>2-4</p>  <p>KG455K-E</p> <p>767K-516M2 (3x2x4)</p>	<p>2-5</p>  <p>M4232 M4240 M4248</p> <p>F007-U22/FP (2x3.2) C007E-W122/CH (2x4.0) C007H-W222/CQ (2x4.8)</p>	<p>2-6</p>  <p>M5232 M5240 M5248</p> <p>F007-U22/FP (2x3.2) C007H-W122/CQ (2x4.0) C007H-W122/CH (2x4.8)</p>
<p>3-1</p>  <p>M4348 M4356 M4364</p> <p>C007-U322/CF (3x4.8) C007E-W152/CZ (3x5.6) C007E-W122/CH (3x6.4)</p>	<p>3-2</p>  <p>M4460</p> <p>F007E-W222/FW (4x6.0)</p>	<p>3-3</p>  <p>M5348 M5356 M5364</p> <p>C007-U322/CF (3x4.8) F007H-W222/CQ (3x5.6) C007H-U162 (3x6.4)</p>	<p>3-4</p>  <p>M9104</p> <p>VC008-04085P (4x1)</p>	<p>3-5</p>  <p>M9108</p> <p>VC008-0864P (8x1/4)</p>	<p>3-6</p>  <p>M9113</p> <p>VC008-1332-032P (1/4x1/8x1/8x1/4)x3</p>
<p>4-1</p>  <p>M9313</p> <p>VC008-13064P 13x1/8</p>	<p>4-2</p>  <p>M9012</p> <p>VC008-12048P (12x3/16)</p>	<p>4-3</p>  <p>M9112</p> <p>VC008-12064P (12x1/4)</p>	<p>4-4</p>  <p>M9117</p> <p>VC008-17 (17x1/8)</p>		

<p>1-1</p>  <p>M9123 VC008-23 (23x1/8)</p>	<p>SUN STAR</p>  <p>GP-001295-00 GP-006765-00</p> <p>SC7300-156M (3x5.6) SC7310-156L (3x5.6) SC7300-164M (3x6.4) SC7310-164L (3x6.4)</p>	<p>1-2</p>  <p>GP-031183-00</p> <p>SC7300H-156M (3x5.6)</p>	<p>1-3</p>  <p>GP-006802-00</p> <p>SC7200-148M (3x4.8) SC7210H-148L (3x4.8)</p>		
<p>2-1</p> <p>SHING LING</p>  <p>FC240 FC248</p> <p>FW777 (2x4.0) (2x4.8)</p>	<p>2-2</p>  <p>FC356 FC364</p> <p>FW777 (3x5.6) (3x6.4)</p>	<p>2-3</p> <p>YAMATO</p>  <p>2109100</p> <p>AZ8000H-04 (0x4) AZ80003H-03 (0x3)</p>	<p>2-4</p>  <p>2109101</p> <p>AZ8020H-Y5 (2.4x5) AZ8020H-Y56 (2.4x6)</p>		
<p>3-1</p>  <p>2109102</p> <p>AZ8020H-X4 (2x4)</p>	<p>3-2</p>  <p>2109110</p> <p>AZ8500H-A4 (3.2x4)</p>	<p>3-3</p>  <p>2109112</p> <p>AZ8500H-CS (5x5)</p>	<p>3-4</p>  <p>2109120</p> <p>AZ6500H-A4 (3.2x4) AZ6500H-A5 (3.2x5)</p>	<p>3-5</p>  <p>2109122</p> <p>AZ6500H-CS (5x5) AZ6500H-C6 (5x6)</p>	<p>3-6</p>  <p>2109132</p> <p>AZ6003H-03 (0x3) AZ6000H-03 (0x3) AZ6016H-02</p>
<p>4-1</p>  <p>2159102</p> <p>AZ6020H (2.4x5) (2.4x6) AZ8020G (2.4x5) (2.4x6)</p>	<p>4-2</p>  <p>2159111</p> <p>AZ6500H-A4 (3.2x4) AZ8500G-A4 (3.2x4)</p>	<p>4-3</p>  <p>2159112</p> <p>AZ6500H AZ8500G (5x5)</p>	<p>4-4</p>  <p>2169113</p> <p>AZ7600G</p>	<p>4-5</p>  <p>93251 93252 93253</p> <p>DV1250-MA (2x3.2) DV1250-MB (2x4.0) DV1250-MC (2x4.8)</p>	<p>4-6</p>  <p>93257</p> <p>DW1350-MD (3x5.6)</p>













FOR INDUSTRIAL SEWING MACHINES

1-1	1-2	1-3	1-4	1-5
 93351 93352 93353 VC2600-132M (2x3.2) VC2600-140M (2x4.0) VC2600-148M (2x4.8)	 93356 93357 93358 VG2700-148M (3x4.8) VG2700-156M (3x5.6) VG2700-156M (3x6.4)	 3109111 3109112 VC2700 (3x5.6) VC2700 (3x6.4)	 3209100 3209101 3209102 VF2400-132M (2x3.2) VF2400-140M (2x4.0) VF2400-148M (2x4.8)	 3209106 3209107 3209108 VF2500-148M (3x4.8) VF2503-156M (3x5.6) VF2503-164M (3x6.4)

FOR INDUSTRIAL SEWING MACHINES

1-1	1-2	1-3	1-4	1-5	1-6
 204536 L32-31/34/36/38/48 335/359	 204521 L32-31/34/36/38/48 335/359	 204042 L32-70/M732-70/86	 204522 L32-70/86	 204634 LS2-01/17	 204659 LS2-13/M752-01/13 16S2/17/23B/54A/55A 180/181
2-1	2-2	2-3	2-4	2-5	2-6
 208053 L32-29/59	 209668 M732-36/38/48/70 355/48P2	 209009 LS2-01/12/17/M752-01 13/16S2/17/23B/54A 55A/180/181/M732-36 38/48/355/48P2	 204536 M732-36/38/48/355 48P2	 209669 M732-36/38/48/355 48P2	 209669A M732-70/86
3-1	3-2	3-3	3-4	3-5	3-6
 257568 W664-01CB/02BB/03FB 34AB/35BB	 257567 W664-01CB/02BB/03FB 34AB/35BB	 277007 EX3216	 277008 EX3216	 277006 EX3216	 277005 EX5203/5204/5205 5214
4-1	4-2		4-3	4-4	4-5
 277004 EX3216/EX5203/5204 5205/5214	 3109200 VC2600/2700		 3109201 VC2600/2700	 68218 FD 62	 68097 FD 62

























<p>1-1</p>  <p>12484002 MO-3904 MO-3914 MO-3916</p>	<p>1-2</p>  <p>12484101 MO-3304</p>	<p>1-3</p>  <p>12484200 MO-3314</p>	<p>1-4</p>  <p>12484507 MO-3316</p>	<p>1-5</p>  <p>12484606 MO-3316</p>	<p>1-6</p>  <p>12177903 MO-3616 MO-3916</p>
<p>2-1</p>  <p>12484408 MO-3616</p>	<p>2-2</p>  <p>11890308 MO-3604 MO-3904 MO-6700</p>	<p>2-3</p>  <p>11890100 MO-3604 MO-3904 MO-6700</p>	<p>2-4</p>  <p>12015301 MO-3616 MO-3916 MO-6700</p>	<p>2-5</p>  <p>12015400 MO-3616 MO-3916 MO-6700</p>	

SANAYİ KONFEKSİYON  
DİKİŞ MAKİNALARI **TAKIMLARI**

























**GAUGE SET** FOR INDUSTRIAL  
SEWING MACHINES



DT6-B927 6.4 mm (1/4) Medium Materials <b>1-1</b>  S11508-101	DT6-B928 6.4 mm (1/4) Extra Heavy Materials <b>1-2</b>  150666-001	DT6-B928-7 3.2 mm x 2 (1/8 x 2) Heavy Materials <b>1-3</b>  148864-001	DT6-B928-6 3.2 mm x 2 (1/8 x 2) Extra Heavy Materials <b>1-4</b>  150667-001	DT6-B927-8 4.8 mm (3/16) Thin Materials Medium Materials <b>1-5</b>  S05946-101
<b>2-1</b>  S40370-001	<b>2-2</b>  150673-001	<b>2-3</b>  148867-101	<b>2-4</b>  150675-101	<b>2-5</b>  S40369-001
<b>3-1</b>  106160-101	<b>3-2</b>  150668-101	<b>3-3</b>  148865-201	<b>3-4</b>  150672-101	<b>3-5</b>  S40355-101
<b>4-1</b>  183978-001	<b>4-2</b>  181716-001	<b>4-3</b>  183954-001		
<b>5-1</b>  148973-001	<b>5-2</b>  148875-001	<b>5-3</b>  S06310-001		
<b>6-1</b>  148876-001-0				
1: 111443003 2: 062671012 3: 021670102 4: 148876-001				

LT2-8875-5-UT				
1/8 <b>1-1</b>  155722-001	3/16 <b>1-2</b>  155851-001	5/16 <b>1-3</b>  155855-001	3/8 <b>1-4</b>  155857-001	1/2 <b>1-5</b>  149677-001
<b>2-1</b>  148699-001	<b>2-2</b>  148703-001	<b>2-3</b>  149691-001	<b>2-4</b>  149938-001	<b>2-5</b>  149675-001
<b>3-1</b>  S36562-001	<b>3-2</b>  S36564-001	<b>3-3</b>  155459-001	<b>3-4</b>  155461-001	<b>3-5</b>  S09367-101
<b>4-1</b>  S15711-001	<b>4-2</b>  S15723-001	<b>4-3</b>  S15747-001	<b>4-4</b>  S15753-001	<b>4-5</b>  S15765-001
<b>5-1</b>  S15712-001	<b>5-2</b>  S15724-001	<b>5-3</b>  S15748-001	<b>5-4</b>  S15754-001	<b>5-5</b>  S15766-001



























LT2-B875-5-UT	EF4-B511-01		EF4-B531		MA4-B551		
5/8	0x3 0x4	0x4 0x6	5(2.2x5) 5(2.2x6)	6(2.2x5) 6(2.2x6)	063 064	065(5x5)	
1-1  149954-001	1-2  146730-001 146732-001 146731-001 146733-001		1-3  146781-001 146782-001		1-4  146501-001 146503-001 146502-001		1-5  146504-001
2-1  149948-001	2-2  146748-001	2-3  156036-001	2-4  146572-001	2-5  146573-001			
3-1  159575-101	3-2  146744-001 146577-001		3-3  146567-001 146577-001		3-4  146568-001 146577-001		
4-1  S15771-001	4-2  146884-001	4-3  146902-001	4-4  146871-101	4-5  146874-101			
5-1  S15772-001	5-2  1Y-1012	5-3  146773-001	5-4  146489-001	5-5  146491-001			















MA4-B551		EF4-N11			
087 (5x5)	092 (5x5)	01-4	01-5	01-4(B) 01-5(B) 01-4(B) (0x4)	01-4(C) 01-5(C)
1-1  146510-001	1-2  S19145-001 S19146-001	1-3  S19155-001 S19154-001		1-4  S19155-001	
2-1  146574-001	2-2  S19236-001	2-3  S19240-001		2-4  S25574-001	
3-1  146569-001 146577-001	3-2  S19199-001	3-3  S19212-001		3-4  S19210-001	
4-1  148013-101	4-2  S19260-001	4-3  S29948-001	4-4  S20494-001 S19271-001		
5-1  146491-001					



FOR INDUSTRIAL SEWING MACHINES

EF4-N21		MA4-N31						
22-4 (2.2x4)	22-5 (2.2x5)	27-5 (2.2x5)	41-5 (2.2x5)	45-5 (2.2x5)	63-3 (3x3)	63-4 (3x4)	63-5 (3x5)	63-5 (3x7)
1-1  S25190-001/S19162-001		1-2  S19166-001		1-3  S19169-001		1-4  S20234-001 S20236-001 S20235-001 S25196-001		
2-1  S19240-001	2-2  S19237-101	2-3  S19240-001	2-4  S19244-101	2-5  S20245-001	2-1  S20244-001			
3-1  S19217-001	3-2  S19202-001	3-3  S19212-001	3-4  S19219-001	3-5  S20241-101 S20242-001 S20243-001	3-1  S20239-101 S19223-101 S20240-001			
4-1  S25543-001/S19280-001	4-2  S19287-201	4-3  S19293-001	4-4  S19297-001	4-5  S19313-201	4-1  S19317-101			
5-1  S20398-001					5-2  S20404-001			

FOR INDUSTRIAL SEWING MACHINES

MA4-N31		MA4-N31 FB-N310			MS-1190	
65-5 (5x5)	65-6 (5x6)	92-5	92-6	92-7	3/16	
1-1  S20232-001		1-2  S20233-001			1-3  S19185-001 S19186-001 S19187-001	
2-1  S20244-001		2-2  S19247-001		2-3  S38597-001		
3-1  S20239-101		3-2  S19228-101 S19229-001 S19223-101		3-3  S38595-001 S38596-001 S19223-101		
4-1  S19317-101		4-2  S19334-001		4-3  S30525-001		
5-1  S20406-001		5-2  S21104-001		5-3  129-25954		





















MO-2414N	MO-2504			
BE6 (2x4)	OA4-150 OA4-150-FG (1.6 mm)	OD4 OD4-FG (3.2) OD4-300 (4.0 mm)	OD4-200 (3.2 mm)	OD6-300 (0x3.2)
1-1  R4305-HOE-E00	1-2  R4200-HOA-C00	1-3  R4200-HOE-D00	1-4  R4200-HOD-D00	1-5  R4300-HOD-E00
2-1  118-86504	2-2  B1657-804-00T		2-3  118-85100	
3-1  118-82404 118-87106	3-2  118-82107 118-87007	3-3  118-82107 118-87106		3-4  118-82206 118-87106
4-1  118-76851	4-2  118-76059	4-3  118-76158	4-4  118-81455	4-5  118-76356
5-1  118-69658	5-2  118-69005			

MO-2514		MO-2516		
BO6-340 (2 x 3.2 mm)	BD4-200 BD4-200-FG	BD4 (2.0x3.2 mm) BD4-FG	DD4-300 (3.2x3.2 mm) DF4-300 (3.2x4.8 mm)	FF6-500 (4.8x4.8 mm)
1-1  R4305-HOD-E00	1-2  R4205-HOD-E00	1-3  R4205-HOD-EA0	1-4  R4508-HOD-D00 R4508-HOF-D00	1-5  R4612-HOF-G00
2-1  118-86504	2-2  B1657-814-B0E	2-3  118-85209	2-4  118-85407	
3-1  118-82404 118-87106	3-2  115-97101 118-87106	3-3  118-82800 118-87403	3-4  118-83006 118-87304	
4-1  118-79251	4-2  118-81554	4-3  118-76851	4-4  118-77552	4-5  118-77750
5-1  118-69658		5-2  118-70359	5-3  118-70458	



<b>MO-2543</b> FDB6-300 (4.8x2.0x3.2) FDB6-300-FG <b>1-1</b>  R4612-HOD-E01		<b>MO-3304E</b> OF6-50H (0x4.8 mm) <b>1-3</b>  R4300-LOF-E00		<b>MO-3305E</b> OE4-41H/L121 (0x3.4) <b>1-5</b>  R4200-LOE-D00	
<b>OE4-40H (0x3.6)</b> <b>1-2</b>  R4200-LOE-E00		<b>DE4-40H/Z192 (0x3.1)</b> <b>1-4</b>  R4200-LZE-E00			
<b>2-1</b>  118-86009		<b>2-2</b>  124-78004		<b>2-3</b>  124-78806	
<b>2-4</b>  124-79101		<b>2-5</b>  124-78301			
<b>3-1</b>  118-84004 118-87403		<b>3-2</b>  12476008 12480000 12478004 124760A6 12476008 12480000		<b>3-3</b>  12476701 12480109 12478806 124767A9 12476701 12480109	
<b>3-4</b>  12476800 12480000 12479101 124768A8 12476800 12480000		<b>3-5</b>  12476305 12480307 12478301 124763A3 12476305 12480307			
<b>4-1</b>  118-78055		<b>4-2</b>  124-66058		<b>4-3</b>  124-66157	
<b>5-1</b>  118-70854		<b>5-2</b>  124-65001		<b>5-3</b>  124-65100	

<b>MO-3314E</b> BE6-44H/G41/Q148 (2.2x3.6) <b>1-1</b>  R4305-LOE-E00		<b>MO-3316E</b> DE6-40H (3x3.8) <b>1-4</b>  R4608-LOE-G00		DE6-42H/S170 (2.2x3.6) <b>1-2</b>  R4305-LOE-E0A	
DE4-40H (3x3.8) <b>1-3</b>  R4508-LOE-G00		DE6-42H/S169 (3x3.8) <b>1-5</b>  R4608-LOE-G0A			
<b>2-1</b>  124-78103		<b>2-2</b>  124-78707		<b>2-3</b>  124-78202	
<b>2-4</b>  124-78905		<b>2-5</b>  124-78608			
<b>3-1</b>  12476107 12480109 12478103 124761A5 12476107 12480109		<b>3-2</b>  12476602 12480109 12478707 124766A0 12476602 12480109		<b>3-3</b>  12476206 12480208 12478202 124762A4 12476206 12480208	
<b>3-4</b>  12476503 12480406 12478608 124765A1 12476503 12480406					
<b>4-1</b>  124-66850		<b>4-2</b>  124-66553		<b>4-3</b>  124-66751	
<b>4-4</b>  124-70050		<b>4-5</b>  124-70357			
<b>5-1</b>  124-65100			<b>5-2</b>  124-65407		



MO-3316E		MO-3343	MO-3904	MO-3914
FF6-40H (4.8x4.8) 1-1	FF6-60H (4.8x4.8) FF6-60H (4.8x6) FF6-50H (4.8x6) 1-2	(4.8x2.2x3.2) 1-3	OE4 (0x4.0) OE4-FG (0x4.0) 1-4	BE6 (2.0x4.0) BE6-FG (2.0x4.0) 1-5
 R4612-LOF-G00	 R4612-LOF-L00 R4612-LOH-L00 R4612-LOH-G00	 R4612-LOD-E01	 R4200-JOE-D00	 R4305-JOE-E00
2-1	2-2	2-3	2-4	2-5
 124-78400	 124-78509	 124-78905	 B1657-804-OOT	 119-49906
3-1	3-2	3-3	3-4	3-5
 12476206 12480208 12476206 12478400 12476206 12476206 12480208 12480208	 12476404 12480208 12476404 12478509 12476404 12476404 12480208 12480208	 12476206 12480208 12476206 12478905 12476206 12476206 12480208 12480208	 118-82107 118-87106	 119-49807 118-87106
4-1	4-2	4-3	4-4	4-5
 124-70159	 124-70258	 124-73153	 118-76158	 121-52450
5-1	5-2	5-3	5-4	5-5
 124-65506	 124-65605	 118-76166	 121-52468	 118-76869
6-1	6-2	6-3	6-4	6-5
 121-48607	 121-48706	 121-50306	 121-50603	 122-75509

MO-3916		MO-3943	MO-6704	MO-6714
OE4 (3.2x4.0) OE4-FG (3.2x4.0) 1-1	DE6 (3.2x4.0) 1-2	FF6 (4.8x4.8) FF6-FG (4.8x4.8) 1-3	FBD6-347/G07/Q141 (4.8x2x3.2) 1-4	OE4-40H (0x4.0) 1-5
 R4508-JOE-D00	 R4608-JOE-D00	 R4612-JOF-D00	 R4612-JOD-E01	 R4200-J6E-D00
2-1	2-2	2-3	2-4	2-5
 121-72805	 121-73209	 121-73308	 131-92802	 121-72003
3-1	3-2	3-3	3-4	3-5
 118-82800 118-87403	 118-82909 118-87106	 118-84004 118-87403	 131-91606 131-91309	 121-71500 118-87106
4-1	4-2	4-3	4-4	4-5
 121-53755	 121-54258	 118-81257	 118-76158	 118-76851
5-1	5-2	5-3	5-4	5-5
 121-53763	 121-54266	 118-81265	 118-76166	 118-76869
6-1	6-2	6-3	6-4	6-5
 121-49803	 121-50306	 121-50603	 122-75509	 122-75509













<b>MO-6714</b> BE4-40H (2x4.0) 1-1  R4205-J6E-E00	<b>MO-6716</b> DE6-40H (3.2x4.0) 1-2  R4608-J6E-D00	<b>MO-6716</b> FF6-40H (4.8x4.8) 1-3  R4612-J6F-D00	<b>MO-6716</b> FF6-60H 1-4  R4612-J6H-K00	<b>MO-6743</b> ID6-40H (4.8x2x3.2) 1-5  R4612-J6D-E01	<b>MO-814</b> BD4 (2.0x3.2) 1-6  R4205-EOD-E00
<b>2-1</b>  B1657-814-B0E	<b>2-2</b>  121-73209	<b>2-3</b>  121-73308	<b>2-4</b>  121-74207	<b>2-5</b>  121-73308	<b>2-6</b>  B1657-804-00C
<b>3-1</b>  115-97101 118-87106	<b>3-2</b>  118-82909 118-87403	<b>3-3</b>  118-84004 118-87403	<b>3-4</b>  121-71104 118-87403	<b>3-5</b>  118-84004 118-87403	<b>3-6</b>  B1656-804-000 B1658-804-000
<b>4-1</b>  118-76851	<b>4-2</b>  121-53755	<b>4-3</b>  121-54258	<b>4-4</b>  121-55552	<b>4-5</b>  118-78055	<b>4-6</b>  B1507-814-0A0
<b>5-1</b>  118-76869	<b>5-2</b>  121-53763	<b>5-3</b>  121-54266	<b>5-4</b>  121-55560	<b>5-5</b>  118-78063	
<b>6-1</b>  122-75509	<b>6-2</b>  122-57507	<b>6-3</b>  122-57507	<b>6-4</b>  121-50702	<b>6-5</b>  122-75004	<b>6-6</b>  B1420-714-B00

<b>MH-380</b> 1/8 (3.2 mm) 1-1  B1103-380-B00	<b>MH-380</b> 3/16 (4.8 mm) 1-2  B1103-380-D00	<b>MH-380</b> 1/4 (6.4 mm) 1-3  B1103-380-F00	<b>MH-380</b> 3/8 (9.5 mm) 1-4  B1103-380-K00	<b>KANSAL SPECIAL</b> UK2004S-01M 0x4 1-5  57-001	<b>UK2014H-01M</b> 2x4 2x5 1-6  57-041 57-051
<b>2-1</b>  B1613-380-B00	<b>2-2</b>  B1613-380-D00	<b>2-3</b>  B1613-380-F00	<b>2-4</b>  B1613-380-K00	<b>2-5</b>  57-201	
				<b>3-1</b>  57-105 57-106 57-1010-1	
<b>4-1</b>  B1509-038-BB0	<b>4-2</b>  B1509-038-DB0	<b>4-3</b>  B1509-038-FB0	<b>4-4</b>  B1509-038-KB0	<b>4-5</b>  57-3010-1	<b>4-6</b>  57-3310-1
<b>5-1</b>  B1406-019-BA0	<b>5-2</b>  B1406-019-DA0	<b>5-3</b>  B1406-019-FA0	<b>5-4</b>  1406-038-KA0	<b>5-5</b>  57-503	<b>5-6</b>  57-505







UK-2005S-10M 0x3 0x4 1-1  57-011 57-021	UK-2004S-20F 0x1.5 1-2  57-031	UK-2014H-40M 2x4 2x5 1-3  57-061 57-071	UK-2116S-01M UK-2116S-02M 3x4 3x5 1-4  57-002	UK-2116S-01H 5x5 1-5  57-012	UK-2116H-03X UK-2116H-03X 5x5 5x6 1-6  57-022 57-032				
2-1  57-211		2-2  57-201		2-3  57-202		2-4  57-212		2-5  57-222	
3-1  57-115 57-116 57-1110-1	3-2  57-115 57-126 57-1210-1	3-3  57-105 57-116 57-1310-1	3-4  57-107 57-108 57-1020-1	3-5  57-117 57-108 57-1120-1	3-6  57-127 57-118 57-1220-1				
4-1  57-3110-1	4-2  57-3210-1	4-3  57-3410-1	4-4  57-3020-1 57-3120-1	4-5  57-3220-1	4-6  57-3320-1				
5-1  57-503	5-2  57-505	5-3  57-504	5-4  57-506						

UK-2116S-30M 3x4 1-1  57-042	UK-2116S-30M 5x5 1-2  57-012	UK-2143H-90M 3x2x4 1-3  57-052	DVK1702B / B2000 (2x6.4) 1-4  14-763	WX8700D / WX8800D (3x5.6) (3x6.4) 1-5  14-890 / 14-891	
2-1  57-232		2-2  57-242		2-3  15-704	2-4  15-805 15-807
3-1  57-137 57-108 57-1320-1	3-2  57-147 57-108 57-1420-1	3-3  57-117 57-108 57-1120-1	3-4  15-843 15-844		
4-1  57-3420-1	4-2  57-3520-1	4-3  57-3620-1	4-4  17-7620-1	4-5  17-7680-1 / 17-7690-1	
5-1  57-504	5-2  57-506	5-3  57-507	5-4  12-2290-1	5-5  12-8380-1 / 12-8390-1	



FOR INDUSTRIAL SEWING MACHINES

<p>RX9700D RX9800D (3x5.6) (3x6.4)</p> <p><b>1-1</b></p>  <p>14-890</p>	<p>RX9700A RX9800A (3x5.6) (3x6.4)</p> <p><b>1-1</b></p>  <p>14-891</p>	<p>WX8800DW (1/4x3N)</p> <p><b>1-2</b></p>  <p>14-880</p>	<p>PX302-4W</p> <p><b>1-3</b></p>  <p>14-3310-1 14-3010-1</p>	<p>LX5802M (2x6.4)</p> <p><b>1-4</b></p>  <p>14-563</p>	<p>1503PHD 1/4</p> <p><b>1-5</b></p>  <p>14-553</p>
<p><b>2-1</b></p>  <p>15-855 15-857</p>	<p><b>2-2</b></p>  <p>15-870</p>	<p><b>2-3</b></p>  <p>15-361</p>	<p><b>2-4</b></p>  <p>15-536</p>	<p><b>2-5</b></p>  <p>15-553 15-555</p>	
<p><b>3-1</b></p>  <p>15-856 15-858</p>	<p><b>3-2</b></p>  <p>15-875</p>	<p><b>3-3</b></p>  <p>15-301</p>	<p><b>3-4</b></p>  <p>15-535</p>	<p><b>3-1</b></p>  <p>15-755 15-753</p>	
<p><b>4-1</b></p>  <p>17-7680-1</p>	<p><b>4-2</b></p>  <p>17-7690-1</p>	<p><b>4-3</b></p>  <p>17-3610-1</p>	<p><b>4-4</b></p>  <p>17-5630-1</p>	<p><b>4-5</b></p>  <p>17-5320-1</p>	
<p><b>5-1</b></p>  <p>12-8180-1 12-8190-1</p>	<p><b>5-2</b></p>  <p>12-8190-1</p>	<p><b>5-3</b></p>  <p>12-3150-1</p>	<p><b>5-4</b></p>  <p>12-5630-1</p>	<p><b>5-5</b></p>  <p>12-5330-1</p>	

FOR INDUSTRIAL SEWING MACHINES

<p>DVK1702D V7002D 1/8" (2x3.2) 5/32" (2x3.2)</p> <p><b>1-1</b></p>  <p>14-724 14-734</p>	<p>DWK1802D V8002D 3/16" (2x4.8) 7/32" (2x5.6) 1/4" (2x6.4)</p> <p><b>1-1</b></p>  <p>14-744 14-764</p>	<p>DVK1703D/V7003D DWK1803D/W8003D 7/32" (3x5.6) 1/4" (3x6.4)</p> <p><b>1-2</b></p>  <p>14-854 14-864</p>	<p>DVK1702DE V7002DE 1/8" (2x3.2) 5/32" (2x4.0)</p> <p><b>1-3</b></p>  <p>14-725 14-735</p>	<p>DWK1802DE W8002DE 3/16" (2x4.8) 7/32" (2x5.6) 1/4" (2x6.4)</p> <p><b>1-3</b></p>  <p>14-745 14-765</p>	<p>DVK1703DE/V7003DE DWK1803E/W8003DE 7/32" (3x5.6) 1/4" (3x6.4)</p> <p><b>1-4</b></p>  <p>14-855 14-865</p>
<p><b>2-1</b></p>  <p>15-724 15-723</p>					
<p><b>3-1</b></p>  <p>15-755 15-753</p>					
<p>DVK1702F V7002F 1/8" (2x3.2) 5/32" (2x3.2)</p> <p><b>4-1</b></p>  <p>14-726 14-736</p>	<p>DVK1703F V7003F 3/16" (2x4.8) 7/32" (2x5.6) 1/4" (2x6.4)</p> <p><b>4-2</b></p>  <p>14-746 14-766</p>	<p>DVK1703F V7003F DWK1803F W8003F 7/32" (3x5.6) 1/4" (3x6.4)</p> <p><b>4-3</b></p>  <p>14-856 14-866</p>	<p>WX8802F 1/8" (2x3.2) 5/32" (2x4.0)</p> <p><b>4-4</b></p>  <p>14-726 14-736</p>	<p>WX8802F 3/16" (2x4.8) 7/32" (2x5.6) 1/4" (2x6.4)</p> <p><b>4-5</b></p>  <p>14-746 14-766</p>	<p>WX8803F 7/32" (3x5.6) 1/4" (3x6.4)</p> <p><b>4-6</b></p>  <p>14-856 14-866</p>
<p><b>5-1</b></p>  <p>15-729</p>	<p><b>5-2</b></p>  <p>15-726 15-727</p>		<p><b>5-3</b></p>  <p>15-813 15-811</p>		
<p><b>6-1</b></p>  <p>15-758</p>	<p><b>6-2</b></p>  <p>15-756</p>		<p><b>6-3</b></p>  <p>15-814</p>	<p><b>6-4</b></p>  <p>15-812</p>	







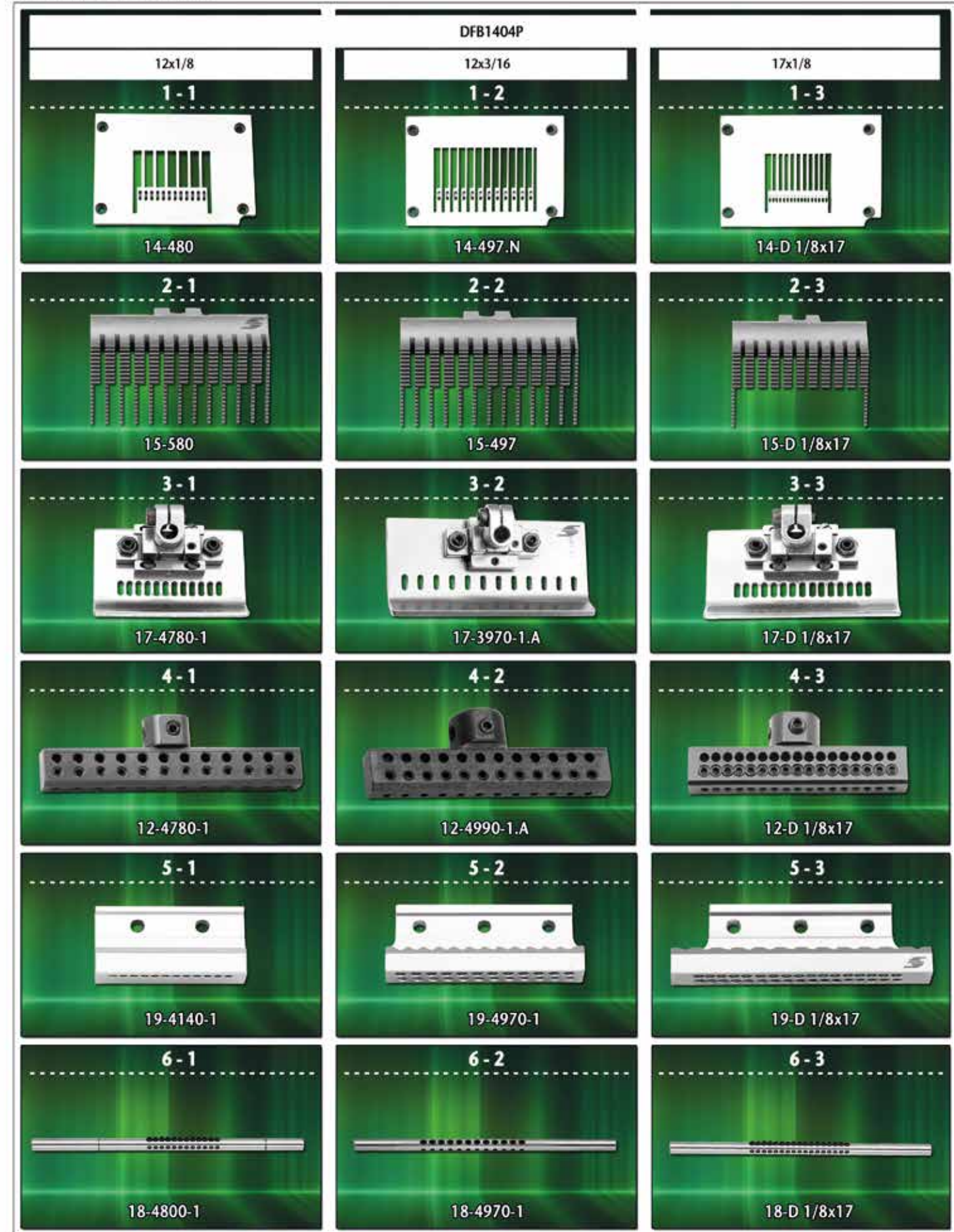
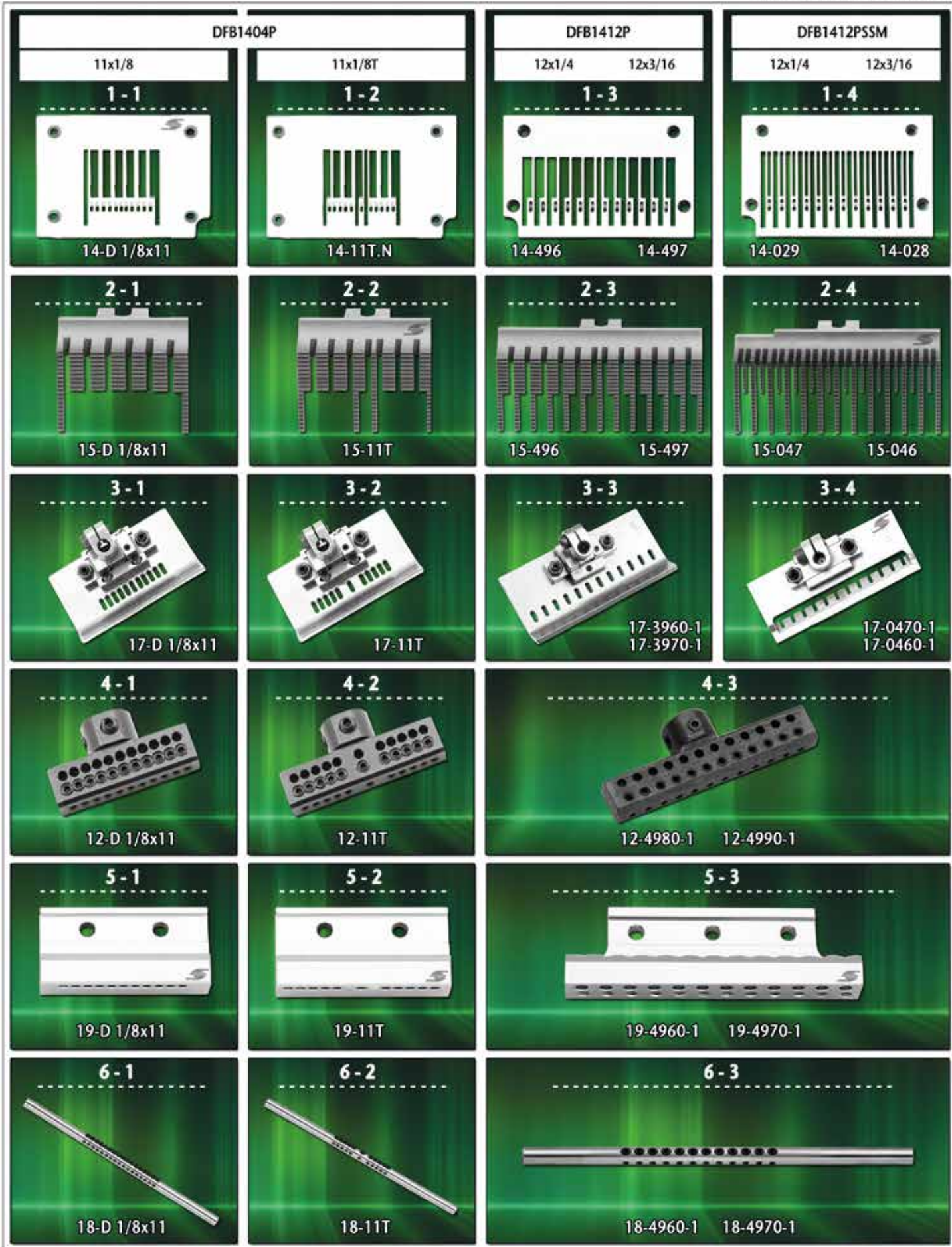



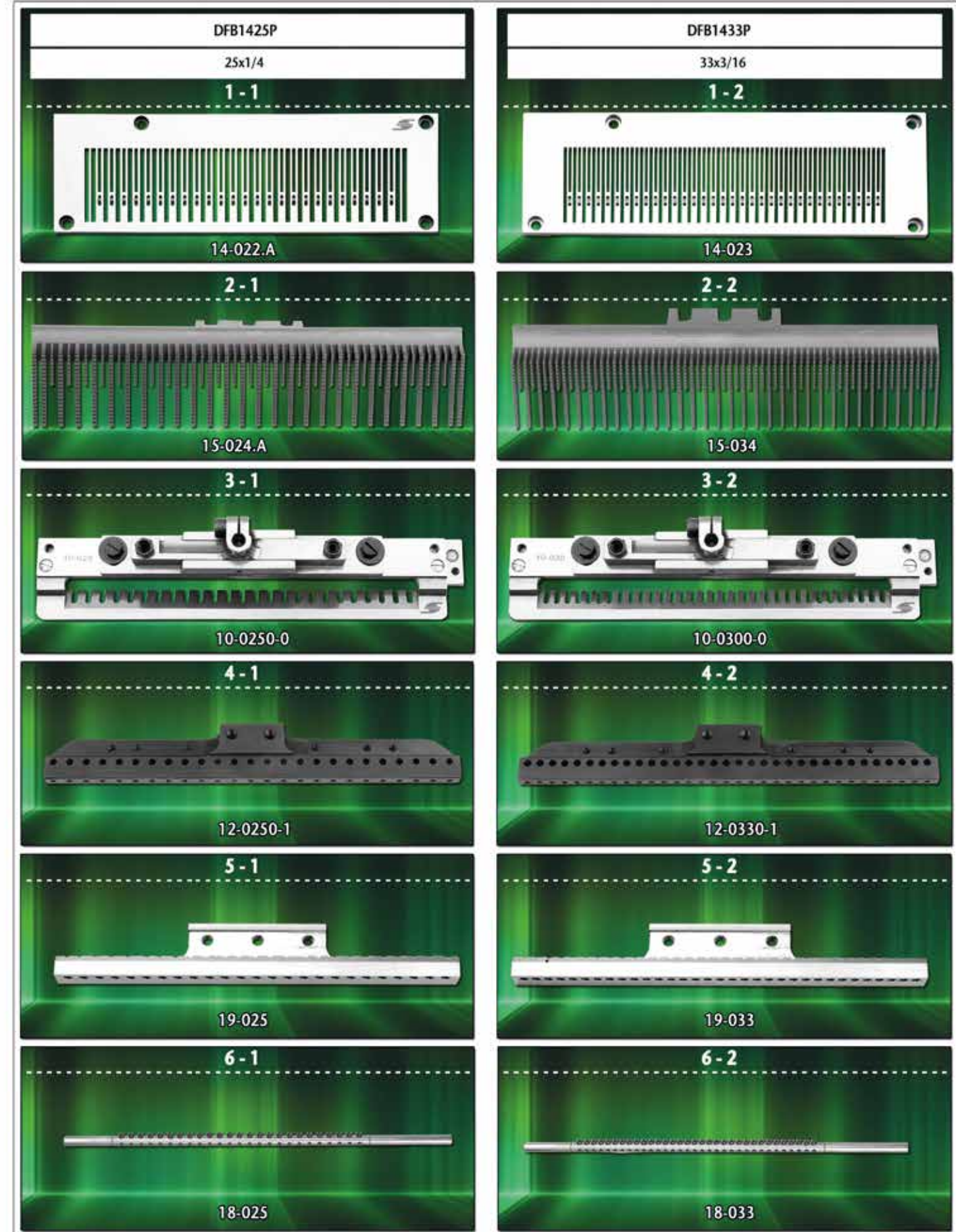
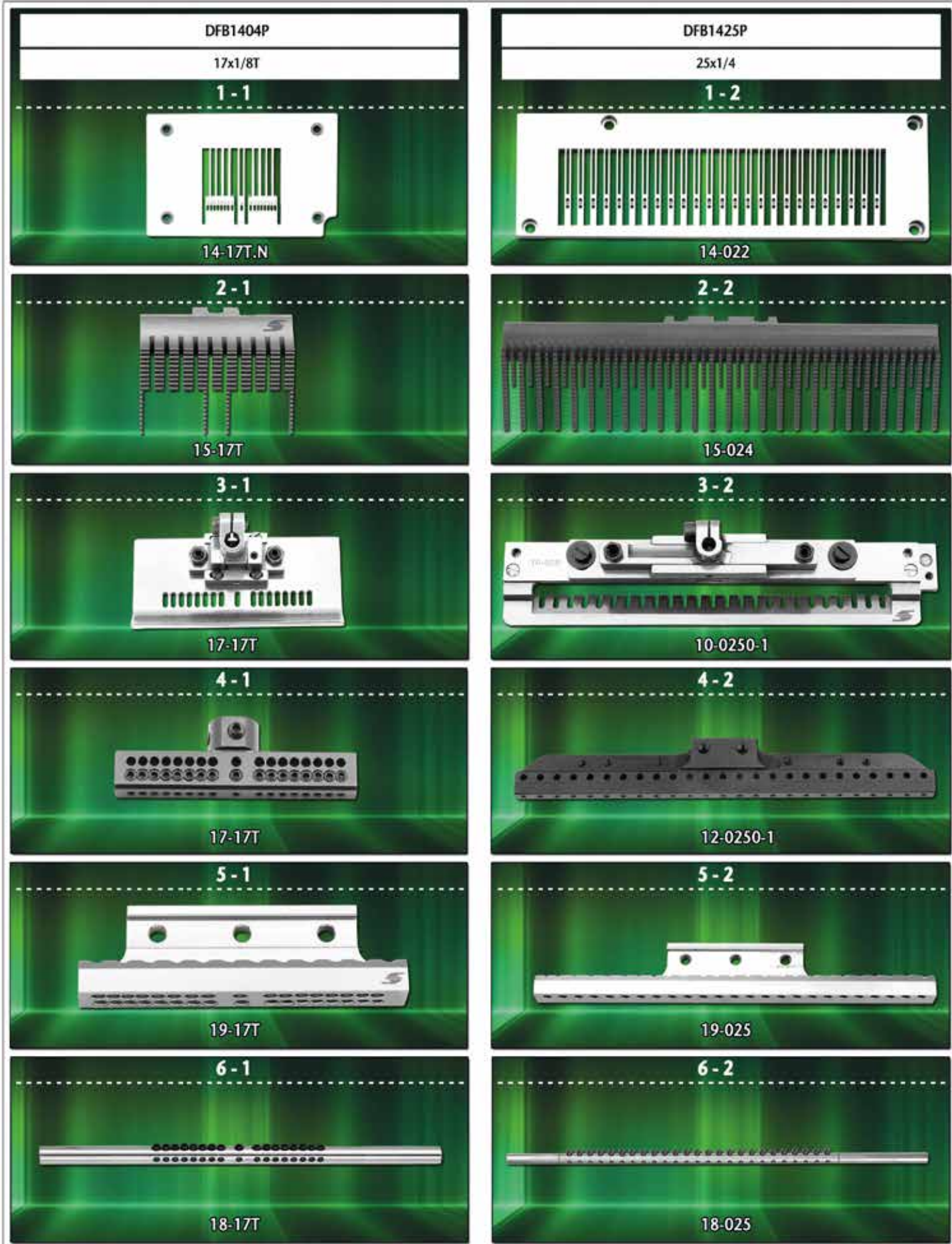



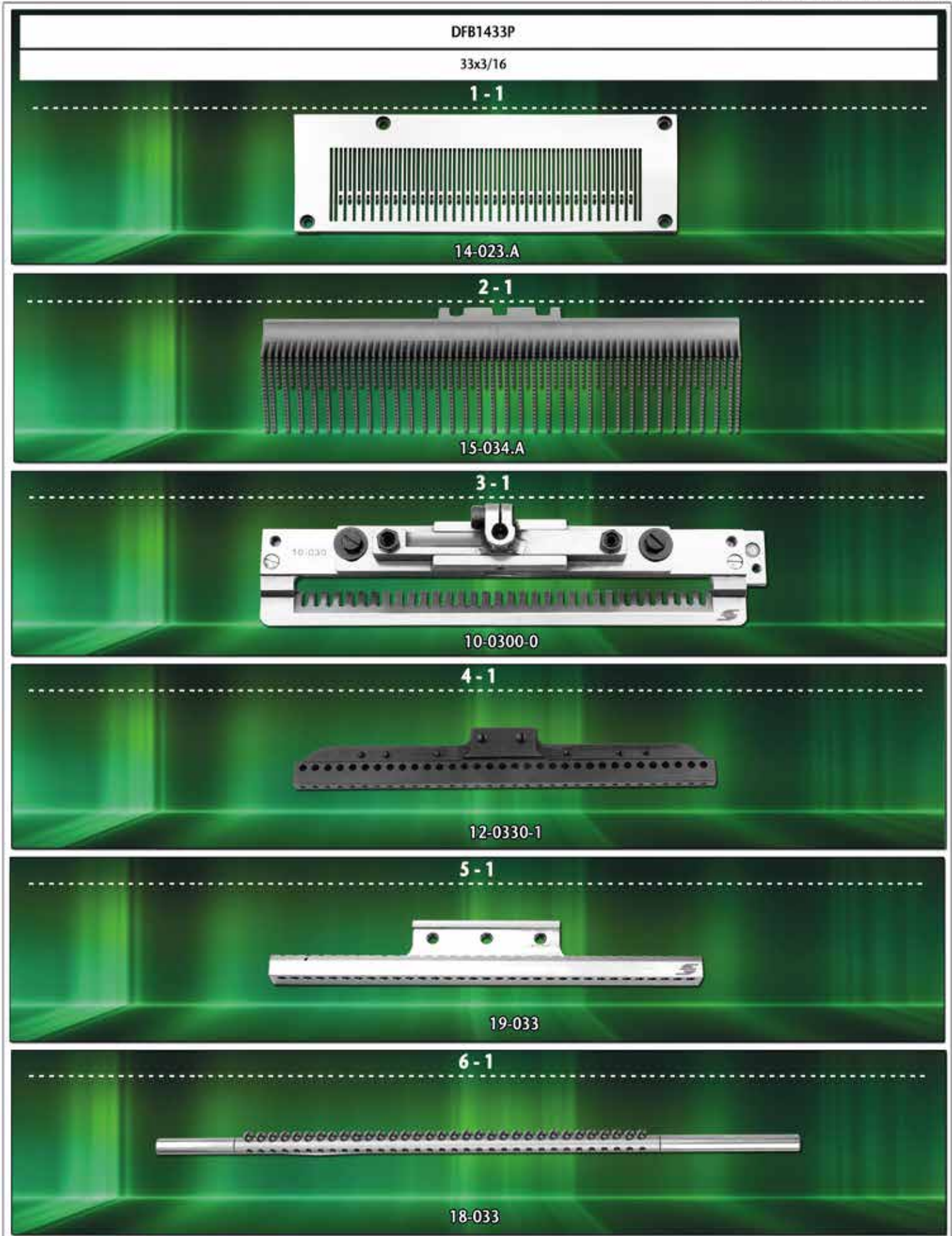





CTD-93-11 2x4.0 2x4.8 1-1 5222TPL1400 5222TPL1480		3x5.6 3x6.4 1-2 5222TPL1560 5222TPL1640		PEGASUS L52-01 0x3 0x4 1-3 202617 205773	L52-05 2x3 3x4 1-4 202702 202675	L52-05S1 2x3 202702	L52-17 0x4 1-5 202546E	
2-1 5220FDL1561		2-2 204730-BF		2-3 204693-BF		2-4 204676-BF		
3-1 5220DFL1561		3-2 204674 204729ABF 208090-BF		3-3 204674 204692ABF		3-4 204674 204675A 208078-BF		
4-1 5222PFL1400 5222PFL1480		4-2 5222PFL1560 5222PFL1640		4-3 208525	4-4 208525	4-5 208525	4-6 208525	
5-1 5220NC00400 5220NC00480		5-2 5220NC00561 5220NC00641		5-3 209670-92		5-4 208905		5-5 209670-92

L52-16 0x1.5 1-1 205465	L52-13 2x3 2x4 1-2 205255 202554E	L52-51 / L52-52 2x4 1-3 205243	L32-31 3x3 3x4 1-4 204294B 204039B	L32-34 3x3 3x4 1-4 204294B 204039B	L32-38 3x3 3x4 3x5 1-5 204366 204367 204368
2-1 204730	2-2 204676-BF		2-3 208215	2-4 208217	2-5 208219
3-1 208912 204729A 208911	3-2 204674 204675A 208078-BF	3-3 204675A 204677 208079-BF	3-4 204248B 208059 208063	3-5 204394 208059 208064	3-6 204396 208060 208066
4-1 201230C/205525	4-2 208525	4-3 208525	4-4 208501		4-5 208504
5-1 209670-92	5-2 208905		5-3 208909		





















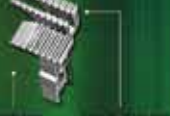

<p>L32-70 5x5 5x6 1-1</p>  <p>204360A/204361A</p>	<p>L32-48 F32-48 F32-49 3x3 3x5 1-2</p>  <p>204939/204941</p>	<p>L32-76 (5x5) 1-3</p>  <p>204380</p>	<p>L32-86 5x5 5x6 1-4</p>  <p>204528/204529</p>	<p>L32-359 3x2x4 1-5</p>  <p>208648</p>	<p>M752-01 0x4 1-6</p>  <p>205773</p>
<p>2-1</p>  <p>208215</p>	<p>2-2</p>  <p>204420</p>	<p>2-3</p>  <p>208225</p>	<p>2-4</p>  <p>208217</p>	<p>2-5</p>  <p>208219</p>	<p>2-6</p>  <p>204730-BF</p>
<p>3-1</p>  <p>204248B 208059 208063</p>	<p>3-2</p>  <p>204931 208061 208074</p>	<p>3-3</p>  <p>204394 208059 208064</p>	<p>3-4</p>  <p>204396 208060 208066</p>	<p>3-5</p>  <p>204674 204729ABF 208090-BF</p>	
<p>4-1</p>  <p>208502</p>	<p>4-2</p>  <p>208508</p>	<p>4-3</p>  <p>208502</p>	<p>4-4</p>  <p>208506/208955</p>	<p>4-5</p>  <p>208649</p>	<p>4-6</p>  <p>208525 201152E/201155C</p>
<p>5-1</p>  <p>208910</p>	<p>5-2</p>  <p>208909</p>	<p>5-3</p>  <p>208910</p>	<p>5-4</p>  <p>208965</p>	<p>5-5</p>  <p>209670-92</p>	

<p>M752-17 0x4 1-1</p>  <p>202546E</p>	<p>M752-16S1 M752-16S2 0x1.5 1-2</p>  <p>205465</p>	<p>M752-180 0x4 1-3</p>  <p>202618A</p>	<p>M752-53A M752-54A 0x4 1-4</p>  <p>205321</p>	<p>M752-13 2x3 2x4 1-5</p>  <p>205255/202554E</p>	<p>M752-23B 2.5x4.5 1-6</p>  <p>209508-45</p>
<p>2-1</p>  <p>204676-BF</p>	<p>2-2</p>  <p>204730</p>	<p>2-3</p>  <p>204730A16F</p>	<p>2-4</p>  <p>204693</p>	<p>2-5</p>  <p>204676-BF</p>	<p>2-6</p>  <p>209417A25F</p>
<p>3-1</p>  <p>204674 204675ABF 208078-BF</p>	<p>3-2</p>  <p>208912 204729A 208911</p>	<p>3-3</p>  <p>204729B16F 204674 208090A16F</p>	<p>3-4</p>  <p>204692A 204677 208083</p>	<p>3-5</p>  <p>204674 204675ABF 208078-BF</p>	<p>3-6</p>  <p>209416-25F 204674 209509-25F</p>
<p>4-1</p>  <p>208525 201230C/201224B</p>	<p>4-2</p>  <p>208525 201230C/205525</p>	<p>4-3</p>  <p>208525 201473B/301433</p>	<p>4-4</p>  <p>208525 212182/210371</p>	<p>4-5</p>  <p>208525 208730/208731 208730/208732</p>	<p>4-6</p>  <p>208525 201230C/208050A</p>
<p>5-1</p>  <p>209670-92</p>	<p>5-2</p>  <p>208905</p>	<p>5-3</p>  <p>208906A92</p>			



M752-55A 2x4 1-1  202983		M752-181 2x4 1-2  209732		M732-36 3x3 3x4 3x5 1-3  204366 204367 204368		M732-38 1-4  204360A/204361A		M732-70 5x5 5x6 1-5  204360A/204361A	
2-1  204693-BF		2-2  209742-16F		2-3  208218		2-4  208219		2-5  208215	
3-1  204692ABF 204677 208083-BF		3-2  209741-16F 204677 209740-16F		3-3  204395 204425 208065		3-4  204396 208060 208066		3-5  204248B 208059 208063	
4-1  208525 212182/201310A		4-2  208525 205253/209734		4-3  208501		4-4  208504		4-5  208502	
5-1  208905		5-2  208905A92		5-3  208909B92		5-4  208910B92			

















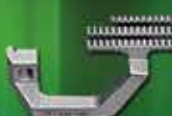

M732-86 5x5 5x6 1-1  204528 204529		M732-48 3x4 1-2  204940		M732-48P2 3x4 1-3  208648		M732-354 M732-355 3x2x4 1-4  2054651			
2-1  208217		2-2  204420		2-3  208219		2-4  2047300			
3-1  204394 208059 208064		3-2  204931 208061 208074		3-3  204396 208060 208066		3-4  2089120 204729A0 2089110			
4-1  208506/208955		4-2  208508		4-3  204502A		4-4  208649		4-5  274018-92B0 201230C0/2055250	
5-1  208910B92		5-2  208909B92		5-3  208965B92		5-4  179630-92			



























M852-01 0x4 1-1  2057731	M852-17 0x4 1-2  20254E1	M852-13 2x4 2x5 1-3  202554E1 202499E1	M832-38 3x4 1-4  2043671	M832-70 5x5 1-5  204360A1
2-1  204730-BFO	2-2  204676-BFO	2-3  2082190	2-4  2082150	
3-1  2046740 204729ABFO 208090-BFO	3-2  2046740 204675ABFO 208078-BFO	3-3  2043960 2080600 2080660	3-4  204248B0 2080590 2080630	
4-1  274018-92B0 201152E0/201155C0	4-2  274018-92B0 201230C0/2103710	4-3  274018-92B0 2087300/2087321	4-4  2771180	4-5  2771190
5-1  179630-920	5-2  277022-920	5-3  277027-921	5-4  277029-920	

M832-86 5x5 1-1  2045291	EX5204-01/223K 0x3 0x4 1-2  277500P30 277500P40	EX5204-02/223K 0x3 0x4 0x5 1-3  277504R30 277504R40 / 277504R50	EX5203-22/223K 0x5 0x6 1-4  277504R50 277504R60	EX5205-12/223K EX5203-12/223K 0x3 0x4 1-5  277500P30 277500P40
2-1  2082170	2-2  277302-16F	2-3  277305-16F	2-4  277302-16F	
3-1  2043940 2080590 2080640	3-2  277301-16F 277318-13 277300-16F	3-3  277304-16F 277318-13 277303-16F	3-4  277304-16F 277318A13 277303A16F	3-5  277301-16F 277318-13 277300-16F
4-1  2771220	4-2  274018-92B 201230C/210370 201230C/210371 201230C/210374	4-3  274018-92B 202799/210371 202799/210372	4-4  274018-92B 201152E/277115 201152E/277103	
5-1  277029-920	5-2  179630-92			



<p>EX5204-32R2/223(K) 0x1.5</p> <p>1-1</p>  <p>277512P15</p>	<p>EX5204-32R2/223L(K) 0x1.5</p> <p>1-2</p>  <p>277502P15</p>	<p>EX5212-02/3333K 2x3 2x4 2x5</p> <p>1-3</p>  <p>277505R30 277505R40 277505R50</p>	<p>EX5214-53/333K EX5214-53C3/333K 2x4 2x5</p> <p>1-4</p>  <p>277505R40 277505R50</p>	<p>EX3216-02/223K 3x4 3x5</p> <p>1-5</p>  <p>277513R40 277513R50</p>
<p>2-1</p>  <p>277302-16F</p>	<p>2-2</p>  <p>277305-16F</p>	<p>2-3</p>  <p>277325-16</p>		
<p>3-1</p>  <p>277301-16F 277309-13 277315-16F</p>	<p>3-2</p>  <p>277304-16F 277318-13 277303-16F</p>	<p>3-3</p>  <p>277324-16F 277318-13 277323-16F</p>		
<p>4-1</p>  <p>274018-92B 202799/205525</p>	<p>4-2</p>  <p>274018-92B 201230C/210503 201230C/210374</p>	<p>4-3</p>  <p>274018-92B 277112/208651</p>	<p>4-4</p>  <p>277118</p>	
<p>5-1</p>  <p>179630-92</p>	<p>5-2</p>  <p>277022-92</p>	<p>5-3</p>  <p>277027-92</p>		

<p>EX3216-03/233K 3x4 3x5</p> <p>1-1</p>  <p>277517R40 277517R50</p>	<p>EX3216-03/233K 5x5 5x6</p> <p>1-2</p>  <p>277516R50 277516R60</p>	<p>EX3215-04/435K EX3216-04/435K 5x5 5x6</p> <p>1-3</p>  <p>277524T50 277524T60</p>	<p>EX3244-03/333K 3x2x4</p> <p>1-4</p>  <p>277518R40</p>	<p>EXT5204-02/233K 0x4</p> <p>1-5</p>  <p>277504R40</p>
<p>2-1</p>  <p>277330-16</p>	<p>2-2</p>  <p>277329-16</p>	<p>2-3</p>  <p>277339-25</p>	<p>2-4</p>  <p>277329-16</p>	<p>2-5</p>  <p>277305-16F</p>
<p>3-1</p>  <p>277328-16 277318-13 277327-16F</p>	<p>3-2</p>  <p>277338-25 277318-13 277337-25</p>	<p>3-3</p>  <p>277327-16</p>	<p>3-4</p>  <p>277303-16F</p>	
<p>4-1</p>  <p>277118</p>	<p>4-2</p>  <p>277119</p>	<p>4-3</p>  <p>277122</p>	<p>4-4</p>  <p>277118A0</p>	<p>4-5</p>  <p>277344</p>
<p>5-1</p>  <p>277027-92</p>	<p>5-2</p>  <p>277028-92</p>	<p>5-3</p>  <p>277029-92</p>	<p>5-4</p>  <p>277030-92</p>	<p>5-5</p>  <p>277149-40</p>
				<p>6-1</p>  <p>179630-92</p>



EXT5214-43/333K 2x4		EXT3215-02/233K 3x4		W561 2x3.2 2x4.0 2x4.8			W562-01 3x4.8		CB/CC 3x5.6 3x6.4	
1-1  277505R40	1-2  277513R40	1-3  257015B32 257015B40 257015B48			1-4  257016B48 257016B56		1-5  257018B56 257018B64			
2-1  277305-16F	2-2  277325-16	2-3  257258-16F			2-4  257259-16F					
3-1  277303-16F	3-2  277323-16	3-3  257206-16F			3-4  257207-16F					
4-1  277345	4-2  277320	4-3  257460-32 257460-40 257460-48		4-4  257461-48 257461-56 257461-64						
5-1  277151-40	5-2  277153-40	5-3  257517-32 257517-40 257517-48			5-4  257518-48 257518-56 257518-64					
6-1  277022-92	6-2  277027-92									

W562-01CA 3x5.6		W561-03 DB W562-03 DB 3x5.6 3x6.4		W562-03DC 3x5.6		W561 2x3.2		W562-02 2x4.0 2x4.8		BB/BC 2x4.0 2x4.8	
1-1  257018A56	1-2  257090B56 257090B64		1-3  257090C56			1-4  257029B32		1-5  257030B40 257030B48			
2-1  257259-16F	2-2  257253-16F		2-3  257260-16F		2-4  257261-16F						
3-1  257207-16F			3-2  257214-16F		3-3  257215-16F						
4-1  257461-56	4-2  257468-64 257468-56 257468-56		4-3  257317A32		4-4  257318A40 257318A48						
5-1  257518-56	5-2  257518-56 257518-64		5-3  257518-56		5-4  257517-32		5-5  257517-40 257517-48				























W561 W562-02 BB/BC 3x5.6 3x6.4		W561-05BB 3x4.8		W562-05 BB 2x3.2 2x4.0 2x4.8			W561 W562-01 DB 3x5.6 3x6.4		W561 W562-01 DB 4x6	
1-1  257033B56 257033B64		1-2  257051B48		1-3  257049B32 257050B40/257050B48			1-4  257053B56 257053B64		1-5  257020-60	
2-1  257262-16F		2-2  257267-16F		2-3  257266-16F 257267-16F			2-4  257268-16F		2-5  257256-16F	
3-1  257216-16F		3-2  257221-16F		3-3  257220-16F 257221-16F			3-4  257222-16F		3-5  257203A16F	
4-1  257321A56 257321A64		4-2  257330A48		4-3  257327A32 257328A40 257328A48			4-4  257331A56 257331A64		4-5  257491-60	
5-1  257518-56 257518-64		5-2  257518-48		5-3  257517-32 257517-40 257517-48			5-4  257518-56 257518-64		5-5  257513-60	

W664-01 CB 2x3.2 2x4.0 2x4.8			W664-03 FB 3x5.6 3x6.4		W664-02 BB 2x3.2 2x4.0 2x4.8			W664-02 BB 3x5.6 3x6.4			
1-1  257015B32 257015B40 257015B48			1-2  257018B56 257018B64		1-3  257097B56 257097B64			1-4  257029B32 257030B40 257030B48		1-5  257033B56 257033B64	
2-1  257289-16F			2-2  257290-16F		2-3  259215-16F			2-4  257291-16F 257292-16F		2-5  257293-16F	
3-1  257242-16F			3-2  257243-16F		3-3  259103-16F			3-4  257244-16F 257245-16F		3-5  257246-16F	
4-1  257460-32 257460-40 257460-48			4-2  257461-56 257461-64		4-3  257468-56 257468-64			4-4  257317A32 257318A40 257318A48		4-5  257321A56 257321A64	
5-1  257517-32 257517-40 257517-48			5-2  257518-56 257518-64		5-3  257517-32 257517-40 257517-48			5-4  257518-56 257518-64		5-5  257518-56 257518-64	























<b>W664-34 AB</b> 2x4.0    2x4.8 <b>1-1</b>  257100B40 257100B48		<b>W664-35 BB</b> 3x5.6    3x6.4 <b>1-2</b>  257102B56 257102B64		<b>W1662-32B</b> 3x5.6    3x6.4 <b>1-3</b>  2Q0018B56D 2Q0018B64D		SIRUBA	<b>737-504M2</b> 04(0x4)    04LFC-2(0x4) <b>1-4</b>  E800		
<b>2-1</b>  259202-16F		<b>2-2</b>  259203-16F		<b>2-3</b>  3G0007016F1			<b>2-4</b>  H445		
<b>3-1</b>  259100-16F		<b>3-2</b>  259101-16F		<b>3-3</b>  259110-16F		<b>3-4</b>  D440    D095 D575			
<b>4-1</b>  257485-40 257485-48		<b>4-2</b>  257486-56 257486-64		<b>4-3</b>  3Q00390356 3Q00390364		<b>4-4</b>  K556 P253E/F371 P253E-3		<b>4-5</b>  K556 P101/F371 P101-3	
<b>5-1</b>  257517-40 257517-48		<b>5-2</b>  257518-56 257518-64		<b>5-3</b>  257542-56 257542-64		<b>5-4</b>  KG131			

<b>737-505F1</b> 03(0x3)    04(0x4) <b>1-1</b>  E783 E784		<b>737-504M1</b> 15(0x4) <b>1-2</b>  E934		<b>737-504M3</b> 04(0x4) <b>1-3</b>  E919		<b>747-512M1</b> 24(2x4)    25(2x5) <b>1-4</b>  E809 E810		<b>747-514M2</b> 24LF-B(2x4)    24TG-B(2x4) <b>1-5</b>  E809		<b>1-6</b>  E805	
<b>2-1</b>  H442				<b>2-2</b>  H445							
<b>3-1</b>  D674    D438 D569		<b>3-2</b>  D912    D438 D290		<b>3-3</b>  D440    D674 D574		<b>3-4</b>  D440    D095 D575		<b>3-5</b>  D440    D674 D574			
<b>4-1</b>  K556 P152D/F155 P152D-3		<b>4-2</b>  K556 P152D/F525 P152D-A		<b>4-3</b>  K556 P253E/F374 P253E-4		<b>4-4</b>  K556 P101/F374 P101-4		<b>4-5</b>  K556 P254G/F504G P254G-4			
<b>5-1</b>  KG131				<b>5-2</b>  KG142							



757-516M2		757-516X2		767-516M2	
35(3x5)	55(5x5)	56(5x6)	324(3x2x4)	524(5x2x4)	
1-1  E982	1-2  E986	1-3  E868	1-4  E989	1-5  E988	
2-1  H497	2-2  H500	2-3  H501	2-4  H497	2-5  H500	
3-1  D489 D502 D581	3-2  D490 D502 D582	3-3  D971 D502	3-4  D972 D502		
4-1  P504	4-2  P502	4-3  P955	4-4  P233-A	4-5  P255-A	
5-1  KG153	5-2  KG155	5-3  KG333	5-4  KG355		

C007J-W522		C007E-U222/CQ		C007E-W122/CH		C007E-W152/CZ		C007E-W222CQ	
3x5.6	3x6.4	3x5.6		2x4.0	3x5.6	3x6.4	3x5.6	2x4.0	
1-1  E6426R E6427R	1-2  E4426P	1-3  E3524P	1-4  E3826P E3827P	1-5  E4326P	1-6  E4124P				
2-1  D3222	2-2  H3362	2-3  H4258 H4259	2-4  H3262	2-5  H3362					
3-1  H3268	3-2  D3216	3-3  D4206 D4207	3-4  D3216						
4-1  P3816R-A P3817-A	4-2  P2116	4-3  P0024	4-4  P0216 P0217	4-5  P2416	4-6  P1814				
5-1  M5356 M5364	5-2  M4356	5-3  M4240	5-4  M4356 M4364	5-5  M4356	5-6  M4240				



FDR  
INDUSTRIAL SEWING MACHINES

<p>C007E-W332/CD 3x5.6 1-1</p>  <p>E3626P</p>	<p>C007E-W332/CE 3x5.6 1-2</p>  <p>E2626P</p>	<p>C007J-W822 3x4.8 3x5.6 3x6.4 1-3</p>  <p>E0225R E0226R E0227R</p>	<p>C007H-W122/CH C007H-W122CH/UTP 2x4.0 2x4.8 1-4</p>  <p>E3524P E3525P</p>	<p>C007-W152/CZ/ UTP/RLO 3x5.6 1-5</p>  <p>E3826P E3827P</p>	<p>C007-W152/CZ/ UTP/RLO 3x5.6 1-6</p>  <p>E4326P</p>
<p>2-1</p>  <p>H4158</p>	<p>2-2</p>  <p>H3159</p>	<p>2-3</p>  <p>D2101</p>	<p>2-4</p>  <p>H4258 H4259</p>	<p>2-5</p>  <p>H3262</p>	
<p>3-1</p>  <p>D4206</p>	<p>3-2</p>  <p>D2107</p>	<p>3-3</p>  <p>H2203R</p>	<p>3-4</p>  <p>D4206 D4207</p>	<p>3-5</p>  <p>D3216</p>	
<p>4-1</p>  <p>P1406</p>	<p>4-2</p>  <p>P2765-A P2766-A P2767-A</p>	<p>4-3</p>  <p>P0024 P0025</p>	<p>4-4</p>  <p>P0216 P0217</p>	<p>4-5</p>  <p>P2416</p>	
<p>5-1</p>  <p>M4356</p>	<p>5-2</p>  <p>M5248 M5356 M5364</p>	<p>5-3</p>  <p>M5240 M5248</p>	<p>5-4</p>  <p>M5356 M5364</p>	<p>5-5</p>  <p>M5356</p>	

FDR  
INDUSTRIAL SEWING MACHINES

<p>C007H-W162 C007H-U162 3x5.6 3x6.4 1-1</p>  <p>E3846 E3847</p>	<p>C007JD-W121/CH 3x5.6 3x6.4 1-2</p>  <p>E3826 E3827</p>	<p>C007H-W222/CQ 2x4.0 2x4.8 1-3</p>  <p>E4124P E4125P</p>	<p>F007J-W222 2x4.0 2x4.8 1-4</p>  <p>E3024 E3025</p>	<p>F007H-W222/CQ 3x5.6 3x6.4 1-5</p>  <p>E4426P E4427P</p>
<p>2-1</p>  <p>H4258 H4259</p>	<p>2-2</p>  <p>H4458 H4459</p>	<p>2-3</p>  <p>H3362</p>	<p>2-4</p>  <p>H1261</p>	<p>2-5</p>  <p>H3362 H3363</p>
<p>3-1</p>  <p>D4206 D4207</p>	<p>3-2</p>  <p>D3216</p>	<p>3-3</p>  <p>D1215</p>	<p>3-4</p>  <p>D3216 D3217</p>	
<p>4-1</p>  <p>P0226 P0227</p>	<p>4-2</p>  <p>P2446-A P2447-A</p>	<p>4-3</p>  <p>P1814 P1815</p>	<p>4-4</p>  <p>P2116-A P2117-A</p>	
<p>5-1</p>  <p>M5356 M5364</p>	<p>5-2</p>  <p>M5240 M5248</p>	<p>5-3</p>  <p>M5356 M5364</p>		



FOR INDUSTRIAL SEWING MACHINES



FOR INDUSTRIAL SEWING MACHINES

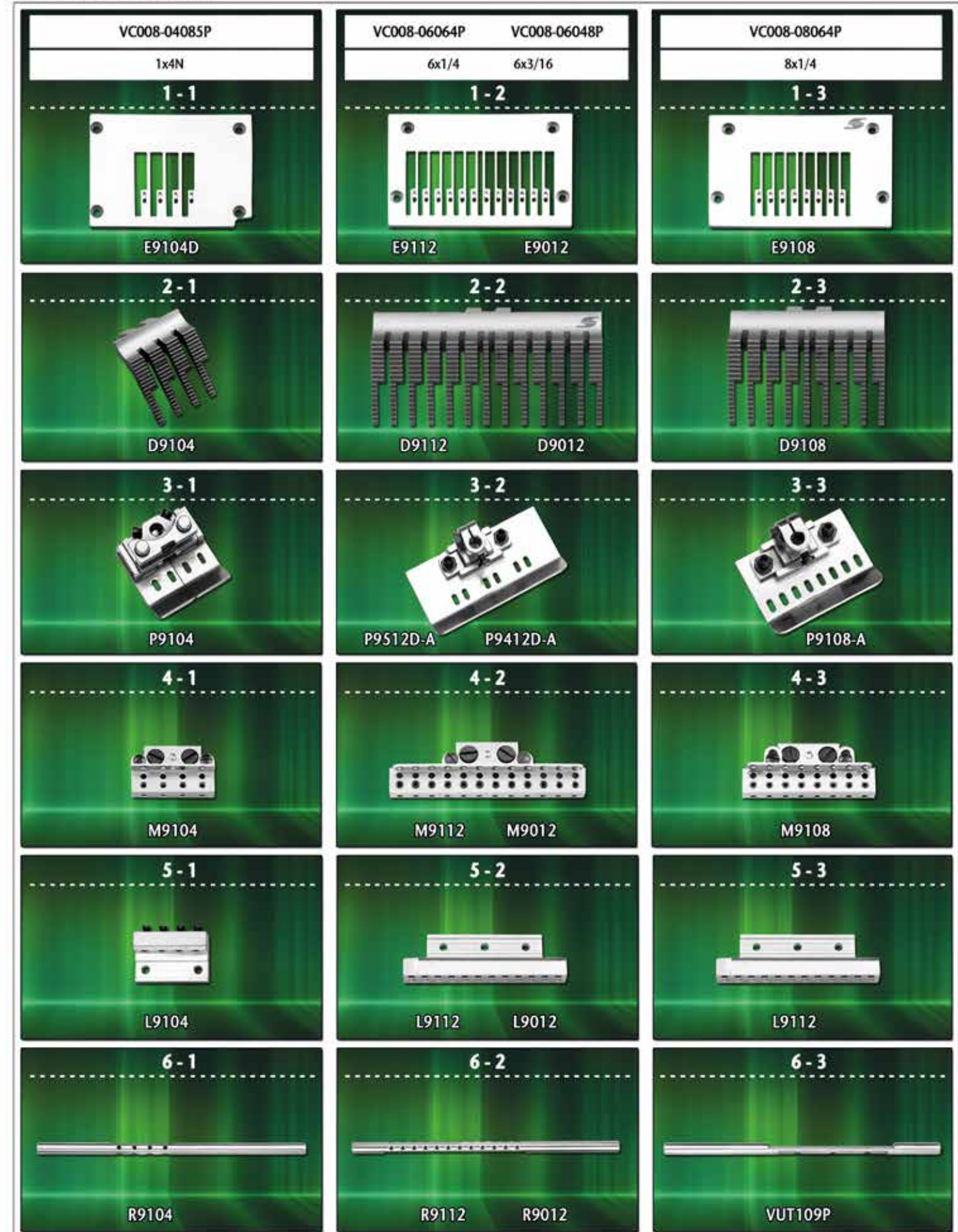



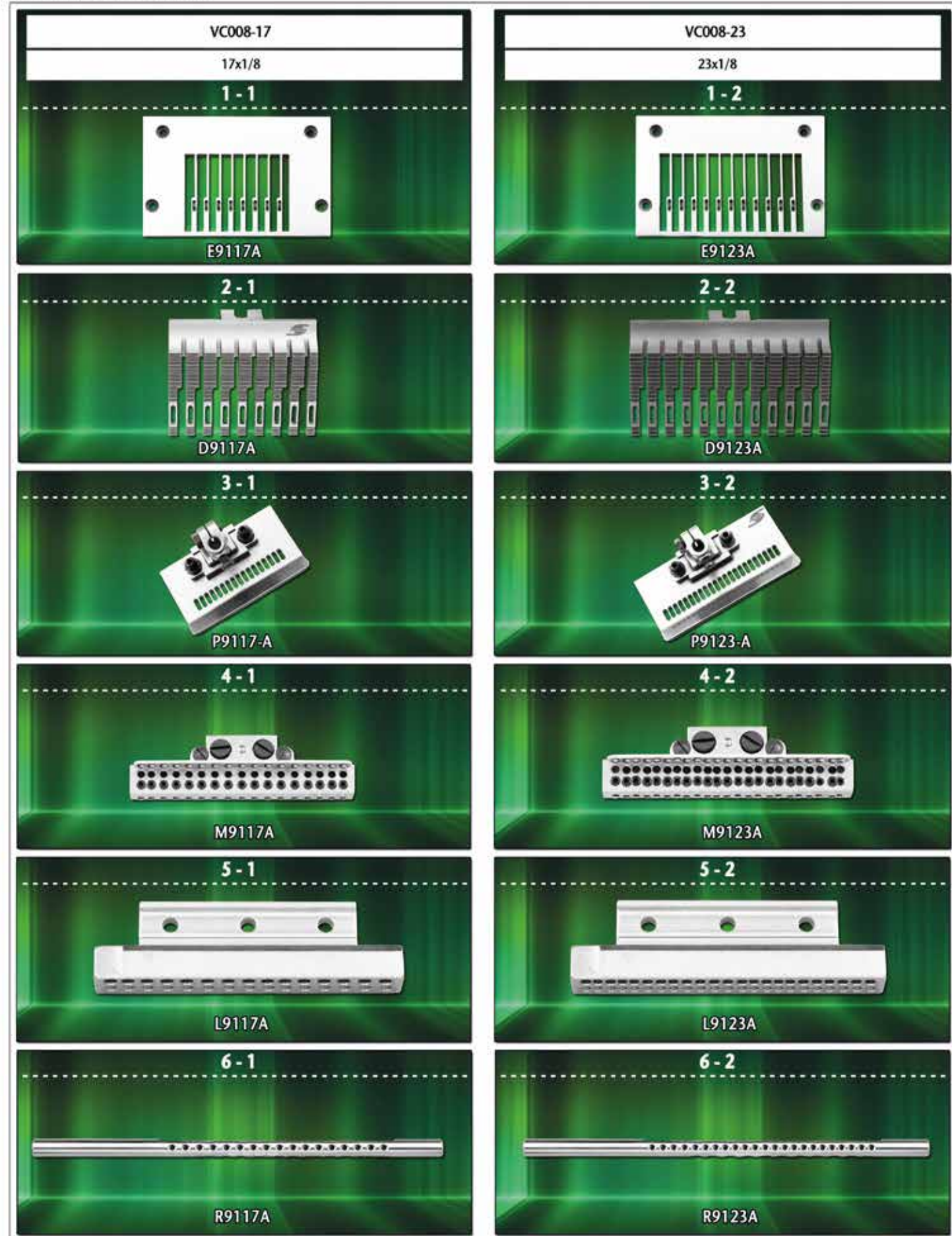
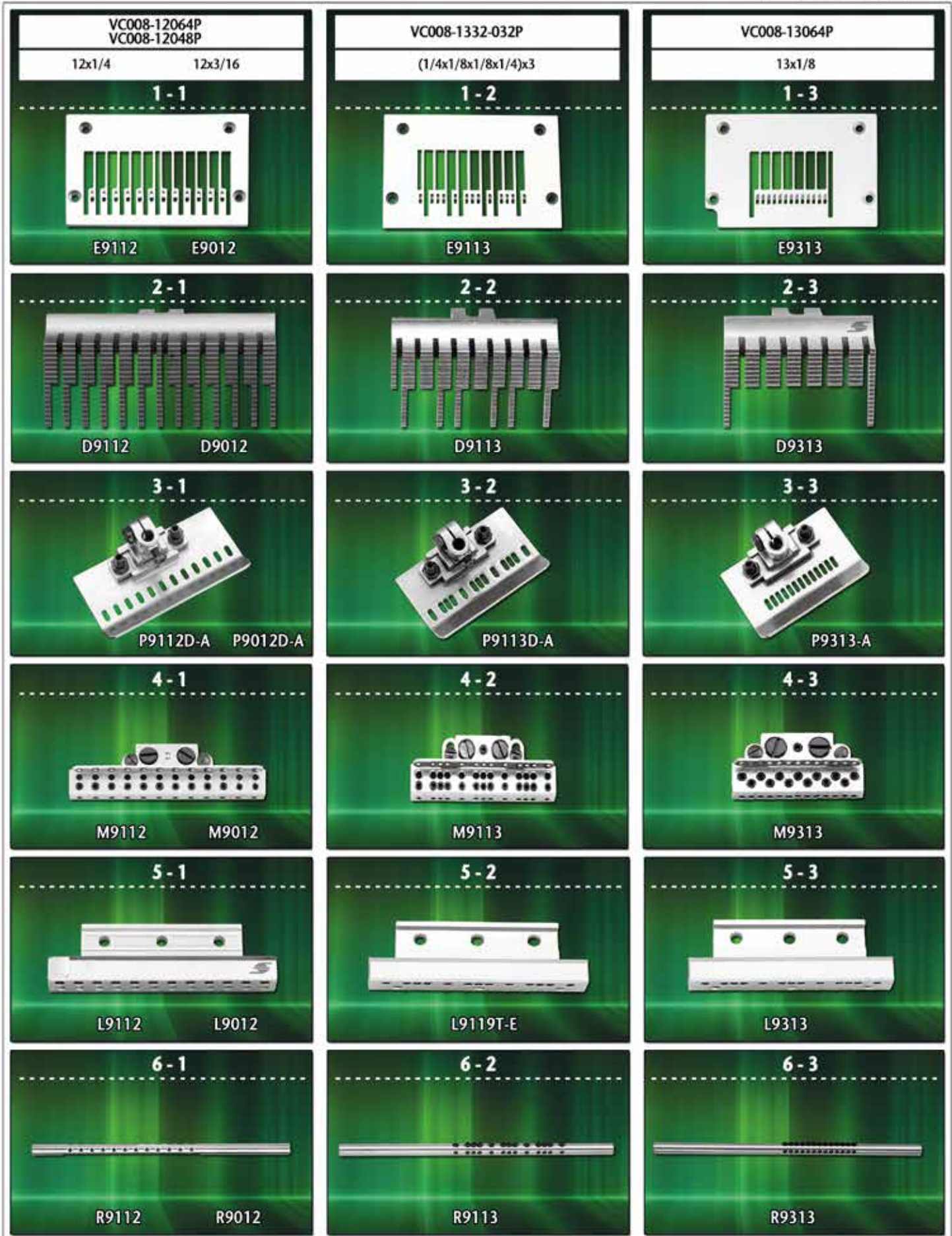





























SC7300 3x5.6 3x6.4		SC7310 3x5.6 3x6.4		SF-7500/BN 3x5.6 3x6.4		AZ8000H 04(0x4) YAMATO		AZ8003H 03(0x3) 04(0x4)			
1-1  GP-001320-00 GP-006766-00		1-2  GP-009973-00 GP-010244-00		1-3  GP-012184-00 GP-012185-00		1-4  2108000		1-5  2108002		1-6  2108003	
2-1  GP-001357-00 GP-006770-00		2-2  GP-009972-00		2-3  GP-012180-00 GP-012186-00		2-4  2109000		2-5  2109007		2-6  2109005	
3-1  GP-001356-00 GP-006769-00		3-2  GP-009971-00		3-3  GP-012179-00 GP-012985-00		3-4  2109001 2109067		3-5  2109006 2109067			
4-1  AS-000288-00 AS-001705-00		4-2  AS-002970-00 AS-003073-00		4-3  AS-003712-00 AS-003713-00		4-4  2107032		4-5  2107300		4-6  2107301	
5-1  GP-001295-00 GP-006765-00						5-2  2109100					





















VF-2200 132M (2x3.2) 140M (2x4.0) 148M (2x4.8)		VF2300 156M (3x5.6)		VF2403 140M (2x4.0)		VF2500 156M (3x5.6)		VF2403 140M-11 (2x4.0)		VF2503 156M-11 (3x5.6)	
1-1  3108130 3108131 3108132		1-2  3108134		1-3  3208103		1-4  94801		1-5  95234		1-6  95085	
2-1  3209001				2-2  3209065		2-3  3209001		2-4  3209009			
3-1  3209080				3-2  3209064		3-3  3209000		3-4  3209008			
4-1  63318 63319 63320		4-2  64041-N		4-3  3207151		4-4  95587		4-5  95238		4-6  95089	
5-1  93351 93352 93353		5-2  93357		5-3  93352		5-4  3209107		5-5  3209101		5-6  3209107	



FOR INDUSTRIAL SEWING MACHINES

<p><b>VF2403</b> 148M(2x4.8) 1-1</p>  <p>94283</p>	<p><b>VF2503-21</b> 156M(3x5.6) 164M(3x6.4) 1-2</p>  <p>3208108 3208109</p>	<p><b>VC2600</b> 132M(2x3.2) 140M(2x4.0) 148M(2x4.8) 1-3</p>  <p>93170 93171 93172</p>	<p><b>VC2700</b> 156L(3x5.6) 1-4</p>  <p>95493</p>	<p><b>VC2700</b> 156M(3x5.6) 1-5</p>  <p>94801</p>	<p><b>VC2700</b> 164M(3x6.4) 1-6</p>  <p>94802</p>
<p>2-1</p>  <p>3209005</p>	<p>2-2</p>  <p>3209065</p>	<p>2-3</p>  <p>3109000</p>		<p>2-4</p>  <p>3109002</p>	
<p>3-1</p>  <p>3209004</p>	<p>3-2</p>  <p>3209064</p>	<p>3-3</p>  <p>3109001</p>		<p>3-4</p>  <p>3109003</p>	
<p>4-1</p>  <p>94217</p>	<p>4-2</p>  <p>3207156 3207157</p>	<p>4-3</p>  <p>63318 63319 63320</p>	<p>4-4</p>  <p>64041-N</p>	<p>4-5</p>  <p>64042-N</p>	
<p>5-1</p>  <p>3209102</p>	<p>5-2</p>  <p>3209107 3209108</p>	<p>5-3</p>  <p>93351 93352 93353</p>	<p>5-4</p>  <p>93358</p>	<p>5-5</p>  <p>93357</p>	<p>5-6</p>  <p>93358</p>

FOR INDUSTRIAL SEWING MACHINES

<p><b>VC2603</b> 140M-11(2x4.0) 1-1</p>  <p>95234</p>	<p><b>VC2703</b> 156M-11(3x5.6) 164M(3x6.4) 1-2</p>  <p>95085 94902</p>	<p><b>VG-2700</b> 132M(2x3.2) 1-3</p>  <p>3508000</p>	<p><b>VG-2700</b> 140M(2x4.0) 1-4</p>  <p>3508001</p>	<p><b>VG2700</b> 148M(3x4.8) 1-5</p>  <p>3508002</p>	<p><b>VG2700</b> 156M(3x5.6) 1-6</p>  <p>3508003</p>
<p>2-1</p>  <p>3109020 3109022</p>	<p>2-2</p>  <p>3509004</p>				
<p>3-1</p>  <p>3109021</p>	<p>3-2</p>  <p>3509005</p>				
<p>4-1</p>  <p>95238</p>	<p>4-2</p>  <p>95089 94909</p>	<p>4-3</p>  <p>3507000-N</p>	<p>4-4</p>  <p>3507002-N</p>	<p>4-5</p>  <p>3507050-N</p>	<p>4-6</p>  <p>3507052-N</p>
<p>5-1</p>  <p>93352</p>	<p>5-2</p>  <p>93357 93358</p>	<p>5-3</p>  <p>93351</p>	<p>5-4</p>  <p>93352</p>	<p>5-5</p>  <p>93356</p>	<p>5-6</p>  <p>93357</p>



VG2700		VG2735		VG3711	VG-3721	
164M(3x6.4)	156M(3x5.6)	164M(3x6.4)	156M(3x5.6)	156M(3x5.6) 156M(3x6.4)	1405I(2x4.0)	1485I(3x4.8)
1-1	1-2	1-3	1-4	1-4	1-5	1-6
3508004	3108002	3108003	3118025 3118026	3508098	3508099	
2-1	2-2		2-3	2-4	2-5	
3509004	3109024		3119020	3509039	3509036	
3-1	3-2		3-3	3-4		
3509005	3109025		3119021	3509037		
4-1	4-2	4-3	4-4	4-5	4-6	
3507054-N	3507108	3507111	3117124 3117126	3507060	3507064	
5-1	5-2	5-3	5-4	5-5	5-6	
93358	93357	93358	93357 93358	93352	93356	

VG-3721		VE2713		FD-62G
156SI(3x5.6)	164SI(3x6.4)	156S-2-K4N(3x5.6)	156L-2-TIN 156L-TIN(3x5.6)	01MR
1-1	1-2	1-3	1-4	1-5
3508100	3508101	3158094	3158082	68490
2-1		2-2	2-3	2-4
3509036		3159034 3159019	3159034 3159012	68096
3-1		3-2		3-3
3509037		3159037		68095
4-1	4-2	4-3	4-4	
3507064 3107273 3107274	3507064	3507052-N	3027092	
5-1	5-2	5-3	5-4	
93357	93358	93357	68053	





BİLGİSAYARLI NAKIŞ  
MAKİNALARI **BIÇAKLARI**

**KNIVES** FOR COMPUTERIZED  
EMBROIDERY MACHINES



FOR  
COMPUTERIZED EMBROIDERY CUTTER

1-1  FX0206010000	1-2  FX0207010000	1-3  FX0205010000	1-4  FX0227000000	1-5  FX0228000000	1-6  FX0229000000	
2-1  FX0206010000(DG)	2-2  FX0207010000(DG)	2-3  FX0221000000	2-4  FX0219000000	2-5  AC0516000000	2-6  AC0517000000	
3-1  AC0518000000	3-2  AT0204000000	3-3  EG0204000000	3-4  EG0206000000	3-5  EG0206020000	PFAFF	
4-1  91-168499-X5	4-2  91-168498-X5	SWF	4-3  08013CL-B001	4-4  04400200B000	4-5  IB-C1201	4-6  IB-TU1204

FOR  
COMPUTERIZED EMBROIDERY CUTTER

1-1  HCA04100	1-2  HCM04293	ZSK	1-3  540012	1-4  572303	1-5  172020201
2-1  172020226	BARUDAN	2-2  KN270950	2-3  KN270960	2-4  KN270952	2-5  KN270961
3-1  HV270080	3-2  HV270040	3-3  HV270340	3-4  HV270310	3-5  KB270010	
OTHERS	4-1  AT020401	4-2  EG020401	4-3  AT020402	4-4  EG020402	



FOR COMPUTERIZED  
CHENILLE EMBROIDERY MACHINES

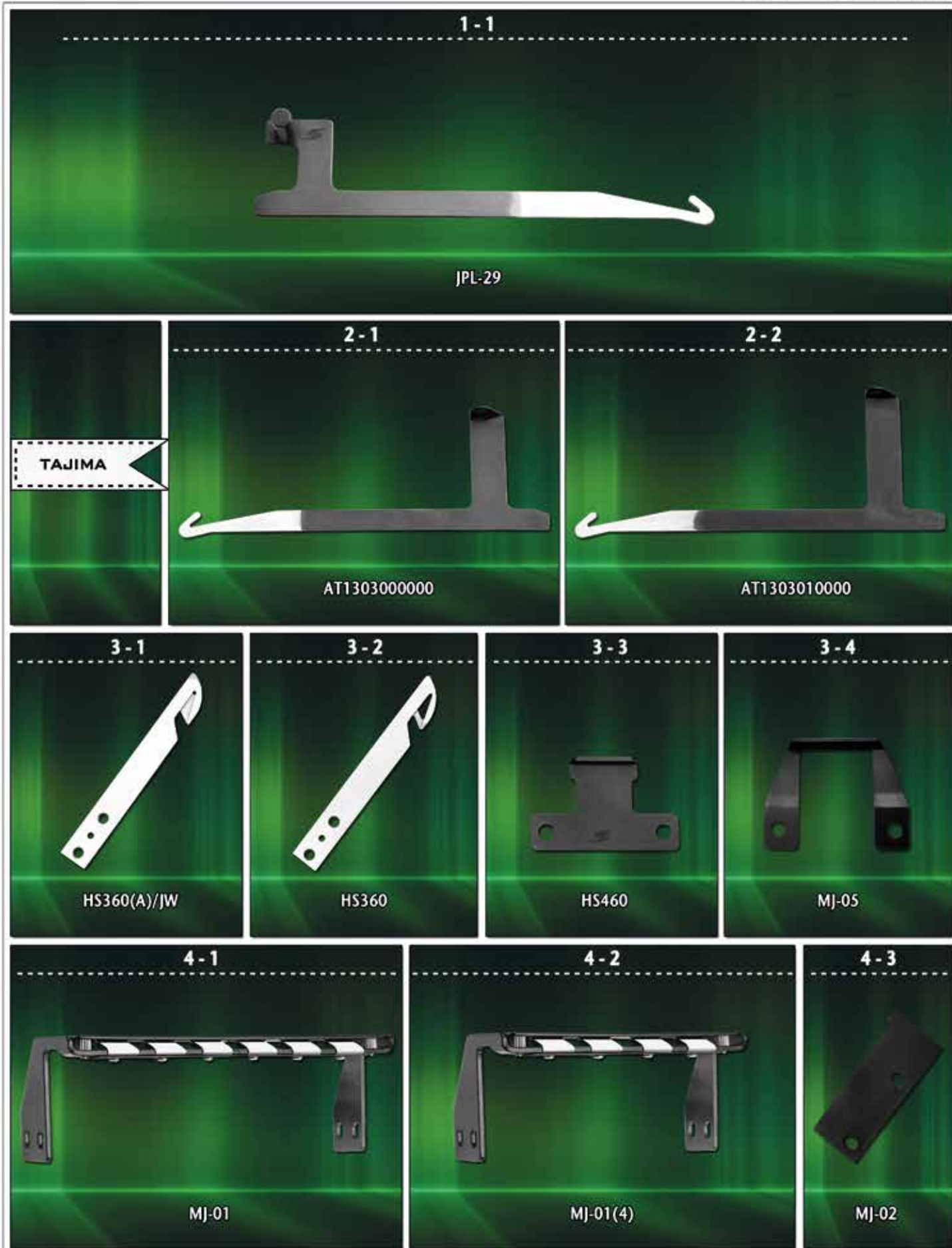

FOR COMPUTERIZED  
CHENILLE EMBROIDERY MACHINES

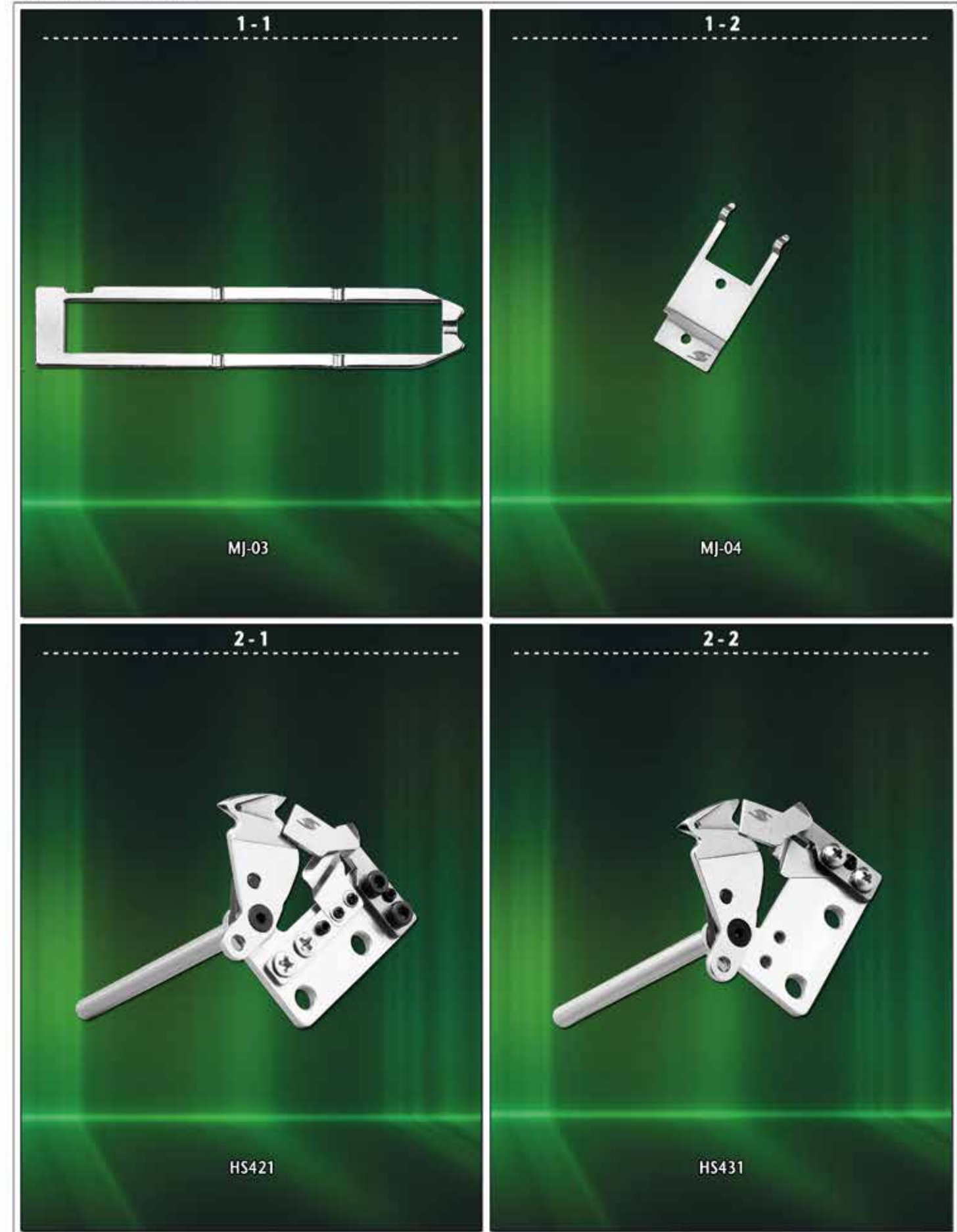



PARÇA KODU / PART NO.	SAYFA / PAGE	SIRA / LINE	PARÇA KODU / PART NO.	SAYFA / PAGE	SIRA / LINE	PARÇA KODU / PART NO.	SAYFA / PAGE	SIRA / LINE	PARÇA KODU / PART NO.	SAYFA / PAGE	SIRA / LINE
0			07-627	16	4-1	103-019	35	4-4	115-97101	162	3-1
004182	102	3-5	07-631	16	4-5	103986	49	4-1	11702	35	3-4
025030-236	63	2-1	07-634	16	4-4	1039895	37	1-6	11703	35	3-5
025030-236	63	2-1	07-702	17	2-6	1039896	37	1-3	118-2000	09	3-3
025030-236	62	2-1	07-703	17	3-5	1039999	37	2-4	118-45609	09	3-5
025030-236	62	2-1	07-707	16	4-6	10400147	85	1-4	118-45708	09	3-6
0252052-141-C	31	2-3	08-005	17	4-4	10502300	12	3-6	118-45807	10	1-1
0252072-145-B	31	2-1	08013CL-B001	208	4-3	105306-101	06	4-3	118-45906	10	1-2
0271001483	07	4-1	08-055	17	4-5	105935	49	2-1	118-46003	08	4-2
0271001497	07	4-2	081008-070	02	1-1	105935-B	49	2-1	118-47407	09	3-4
028030-246	62	2-1	1			106160-101	125	2-3	118-47506	09	3-1
028030-246	63	2-1	1-11 (3mm)	37	4-2	106160-101	150	3-1	118-47605	08	4-3
0281 350300	07	4-3	1-8(5mm)	37	4-3	107-26305	15	4-2	118-69005	156	5-2
0281 350310	07	4-4	1-8A(3mm)	37	4-1	107-26404	15	4-3	118-69005	139	3-4
03-012	36	4-1	10-001A-120H	29	3-2	108065-S	49	3-1	118-69658	139	3-5
030-0095-00	06	4-5	10-001A-2700	29	2-3	109148	49	1-1	118-69658	156	5-1
030-0096-00	06	4-6	10-001A-64L7	29	4-2	10E	57	2-1	118-69658	157	5-1
030-0097-00	07	1-1	10-002A-7507	29	3-3	10E(TFL)	57	3-1	118-69955	139	4-1
030-0098-00	07	1-2	10-002A-8677	29	4-6	10EW	58	2-1	118-70359	139	4-2
030-0461-00	06	4-4	10-005A-2700	29	2-4	10EW(KO)	58	2-1	118-70359	157	5-2
030-0461-00(TI)	06	4-4	10-006A-120H	29	3-1	10KM	57	1-1	118-70458	139	4-3
040075C-5030	71	2-1	10-006A-235B	29	2-2	10KMW	58	1-1	118-70458	157	5-3
044002008000	208	4-4	10-007A-7507	29	3-4	10S0405-306H	71	2-1	118-70854	139	4-4
05-429	18	1-1	10-008A-64L7	29	4-1	10S0425-306H	71	2-1	118-70854	168	5-1
05-447	18	1-2	10-011A-8677	29	4-5	10S0455-306H	29	3-6	118-76059	126	3-5
05-548	17	4-6	10-0250-0	131	3-1	10S0455-306H	70	2-1	118-76059	156	4-2
05-549	18	1-3	10-0250-0	172	3-2	10S0465-306H	70	2-1	118-76067	126	3-6
05-658	17	3-3	10-0250-0	173	3-1	10S0475-306H	29	3-5	118-76158	126	4-1
05-812	17	3-4	10-0300-0	131	4-1	10S0475-306H	71	2-1	118-76158	156	4-3
05-878	17	3-2	10-0300-0	173	3-2	10S0485-306H	71	2-1	118-76158	161	4-4
0580 330040	39	4-2	10-0300-0	174	3-1	10S0505-306H	71	2-1	118-76158	160	4-4
0580 330050	39	4-2	10-041A-120H	103	3-1	10S0535-306H	71	2-1	118-76166	126	4-2
0580 330060	39	4-2	10-043A-120M	103	3-2	10S0565-306H	71	2-1	118-76166	161	5-4
0580 330070	39	4-2	10-051W-120H	71	2-1	10S0575-306H	71	2-1	118-76166	160	5-3
0580 330080	39	4-2	10-052W-120H	71	2-1	10S0585-306H	71	2-1	118-76356	126	4-5
0580 330090	39	4-2	10-054W-120H	71	2-1	10S0595-306H	71	2-1	118-76356	156	4-5
0580 330100	39	4-2	10-101A-2700	29	2-6	10S0605-306H	71	2-1	118-76364	126	4-6
0580 330110	39	4-2	10-1069-0-001	40	4-3	11 1/2E	57	2-1	118-76851	127	2-1
0580 330120	39	4-2	10-1069-0-002	40	4-3	11 1/2KM	57	1-1	118-76851	156	4-1
0580 330130	39	4-2	10-1069-0-003	40	4-3	110-40052	11	3-6	118-76851	157	4-3
0580 330140	39	4-2	10-1069-0-004	40	4-3	110-40052/M	11	4-1	118-76851	161	4-5
0580 330150	39	4-2	10-1069-0-005	40	4-3	110-40201	11	4-6	118-76851	162	4-1
0580 330380	39	3-3	10-1069-0-006	40	4-3	110-40508	13	2-2	118-76869	126	3-4
0580 330390	39	3-2	10-1069-0-007	40	4-3	110-42652	13	1-5	118-76869	161	5-5
06-351	17	3-5	10-1069-0-051	40	4-1	110-93259	11	4-2	118-76869	162	5-1
06-632	17	3-6	10-1069-0-052	40	4-1	110-95403	12	2-2	118-77156	127	1-1
062300-416	62	2-1	10-1069-0-054	40	4-1	110-95601	13	2-1	118-77164	127	1-2
062300-416	62	2-1	10-1069-0-055	40	4-1	111-150-000	40	2-2	118-77552	127	2-2
062300-416	63	2-1	10-1069-0-056	40	4-1	111-151-000	40	2-2	118-77552	157	4-4
062300-416	63	2-1	10-1069-0-060	40	4-1	111-152-000	40	2-2	118-77578	127	3-2
062670-712	64	1-1	10-106A-2700	29	2-5	111-153-000	40	2-2	118-77750	127	2-4
07-124	17	1-5	10-1197-1	31	1-1	111-154-000	40	2-2	118-77750	157	4-5
07-125	16	2-3	10-140A-120H	103	2-3	111-155-000	40	2-2	118-77768	127	2-5
07-168	17	2-1	10-143A-120K	103	3-1	111-156-000	40	2-2	118-78055	127	2-6
07-169	16	2-4	10-3072-0-014	40	3-2	111140-002	62	1-1	118-78055	162	4-5
07-170	17	1-4	10-3072-0-014/M	40	3-3	111140-002	63	1-1	118-78055	168	4-1
07-206	16	2-5	10-3072-0-024	40	2-3	112436-001	02	1-1	118-78063	127	3-1
07-406	17	1-6	10-3072-0-024/M	40	3-1	113-043-000	40	2-1	118-78063	162	5-5
07-432	16	3-1	100-01709	13	3-6	113-13053	12	3-1	118-79251	127	1-3
07-505	17	1-3	100105005	64	1-1	113-51400	13	2-6	118-79251	157	4-1
07-507	16	3-2	100360-003	62	1-1	113-51509	13	3-1	118-79269	127	1-4
07-522	16	3-3	100360-003	62	2-1	114-023-000	37	4-4	118-81257	128	2-3
07-529	16	3-4	100360-003	63	2-1	114-09257	12	1-3	118-81257	161	4-3
07-544	17	2-3	100360-003	63	1-1	114-09257/M	12	1-4	118-81265	128	2-4
07-545	17	2-4	101491-101	125	2-2	114-09604	12	1-5	118-81265	161	5-3
07-558	16	3-5	102-11100	16	1-4	114-09604/M	12	1-6	118-81455	126	4-3
07-570	17	2-2	102-11118	16	1-4	115-21903	10	2-6	118-81455	156	4-4
07-596	16	3-6	102-11209	16	1-3	115-65900	09	4-6	118-81471	126	4-4
07-597	17	2-5	102-32403	16	1-2	115-66502	08	4-1	118-81554	127	1-5
07-621	16	4-3	10211605	16	2-1	115-97101	107	3-4	118-81554	127	4-2
07-626	16	4-2	103-002	36	2-5	115-97101	157	3-2	118-81570	127	1-6

PARÇA KODU / PART NO.	SAYFA / PAGE	SIRA / LINE	PARÇA KODU / PART NO.	SAYFA / PAGE	SIRA / LINE	PARÇA KODU / PART NO.	SAYFA / PAGE	SIRA / LINE	PARÇA KODU / PART NO.	SAYFA / PAGE	SIRA / LINE
118-82107	107	3-2	118-87403	162	3-4	121-50702	162	6-4	124-78806	158	2-3
118-82107	108	2-2	118-87403	162	3-5	121-52450	160	4-5	124-78905	159	2-4
118-82107	108	4-6	118-87403	109	3-4	121-52450	127	4-6	124-78905	160	2-3
118-82107	156	3-2	11890100	148	2-3	121-52451	128	1-2	124-79101	158	2-4
118-82107	156	3-3	11890308	148	2-2	121-52468	128	1-1	12447504	09	1-5
118-82107	160	3-4	119-49807	109	1-4	121-52468	160	5-4	12466058	127	3-2
118-82206	107	2-3	119-49807	160	3-5	121-52955	128	1-3	12466157	127	3-3
118-82206	156	3-4	119-49906	109	1-3	121-52963	128	1-4	12466157	168	4-3
118-82404	107	2-5	119-49906	160	2-5	121-53755	128	1-5	12466553	127	3-5
118-82404	156	3-1	12-0250-1	141	4-1	121-53755	161	4-1	12466553	159	4-2
118-82404	157	3-1	12-0250-1	173	4-1	121-53755	162	4-2	12466751	127	3-6
118-82800	107	3-6	12-0250-1	172	4-2	121-53763	128	1-6	12466751	159	4-3
118-82800	109	1-6	12-0330-1	141	4-2	121-53763	161	5-1	12466850	127	3-4
118-82800	157	3-3	12-0330-1	173	4-2	121-53763	162	5-2	12466850	159	4-1
118-82800	161	3-1	12-0330-1	174	4-1	121-53763	128	2-1	12470050	127	4-1
118-82909	109	2-2	12-11T	141	2-2	121-54258	161	4-2	12470050	159	4-4
118-82909	109	3-4	12-11T	170	4-2	121-54258					



PARÇA KODU / PART NO.	SAYFA / PAGE	SIRA / LINE	PARÇA KODU / PART NO.	SAYFA / PAGE	SIRA / LINE	PARÇA KODU / PART NO.	SAYFA / PAGE	SIRA / LINE	PARÇA KODU / PART NO.	SAYFA / PAGE	SIRA / LINE
12478301	108	1-5	135-48102	128	4-4	14-566	84	1-5	14-790	86	2-5
12478400	108	4-1	135-48201	128	4-3	14-580	87	4-3	14-791	86	2-5
12478509	108	4-3	135-54308	128	3-4	14-581	87	3-1	14-800	87	2-3
12478608	108	3-5	135-54407	128	3-5	14-581	169	1-1	14-801	85	2-4
12478707	108	2-5	135-71906	128	4-2	14-582	87	3-1	14-802	85	2-4
12478806	108	1-1	135-72003	128	4-1	14-583	87	3-1	14-806	168	1-3
12478905	108	3-3	137-31161	15	3-1	14-611	86	4-2	14-806	84	2-4
12479101	108	1-3	137-35469	15	3-2	14-612	86	4-2	14-807	84	2-4
12480000	107	4-6	137562	21	3-3	14-613	86	4-3	14-807	168	1-3
12480000	108	1-4	138-81255	12	4-5	14-614	86	4-3	14-808	84	2-4
12480000	158	3-2	138559	22	1-2	14-615	86	4-4	14-808	168	1-3
12480000	158	3-2	13879800-1	54	1-1	14-616	86	4-5	14-811	86	1-2
12480109	108	1-2	13E	57	2-1	14-617	86	4-6	14-812	86	3-4
12480109	108	2-4	13EW	58	2-1	14-618	86	4-6	14-813	86	3-4
12480109	108	2-6	13KM	57	1-1	14-619	85	1-5	14-814	86	1-2
12480109	158	3-3	14-022	89	1-1	14-724	84	1-1	14-818	84	3-4
12480109	158	3-3	14-022	172	1-2	14-724	167	1-1	14-819	84	3-4
12480109	168	3-3	14-022.A	89	2-1	14-725	167	1-3	14-819	168	1-2
12480208	108	3-2	14-022.A	173	1-1	14-725	84	1-3	14-820	84	3-4
12480208	108	3-4	14-023	89	3-1	14-726	85	4-2	14-820	168	1-2
12480208	108	4-2	14-023	173	1-2	14-726	167	4-1	14-843	84	2-6
12480208	108	4-4	14-023.A	89	4-1	14-726	167	4-4	14-844	84	2-6
12480208	159	3-3	14-023.A	174	1-1	14-728	85	4-3	14-845	84	2-6
12480208	160	3-3	14-028	88	1-1	14-734	84	1-1	14-846	85	2-5
12480208	160	3-1	14-028	170	1-4	14-734	167	1-1	14-847	85	2-5
12480208	160	3-2	14-029	88	1-2	14-735	84	1-3	14-854	167	1-2
12480307	108	1-6	14-029	170	1-4	14-735	167	1-3	14-854	84	3-2
12480307	168	3-5	14-111.N	88	2-1	14-736	85	4-2	14-854C	85	3-1
12480406	108	3-6	14-111.N	170	1-2	14-736	167	4-1	14-854D	85	3-2
12480406	159	3-4	14-176	86	1-3	14-736	167	4-4	14-855	84	3-3
12484002	148	1-1	14-177	86	1-3	14-744	84	1-1	14-855	167	1-4
12484101	148	1-2	14-171.N	88	3-2	14-744	167	1-1	14-855	168	1-5
12484200	148	1-3	14-171.N	172	1-1	14-745	84	1-4	14-856	167	4-3
12484408	148	2-1	14-183	86	3-6	14-745	167	1-3	14-856	167	4-6
12484507	148	1-4	14-184	86	4-1	14-745	168	1-4	14-856	86	2-1
12484606	148	1-5	14-185	86	4-1	14-746	167	4-2	14-856B	86	1-5
129-23405	79	4-1	14-186	85	4-1	14-746	85	4-4	14-857	86	1-6
129-23405	155	1-4	14-187	85	4-1	14-746	167	4-5	14-858	86	2-2
129-25954	140	3-5	14-192	86	1-4	14-748	85	4-3	14-859	85	1-6
129-25954	155	5-3	14-3010-1	84	4-6	14-754	84	1-1	14-860	168	1-1
129-27760	126	3-2	14-3010-1	166	1-3	14-754	167	1-1	14-860	85	2-6
129-27760	155	4-4	14-3170-1	86	3-5	14-755	84	1-4	14-861	85	2-6
129-32307	107	1-5	14-3310	85	1-3	14-755	167	1-3	14-862	85	2-6
129-32307	155	2-4	14-3310-1	166	1-3	14-755	168	1-4	14-862	168	1-1
12922704	10	3-4	14-3320	85	1-2	14-756	85	4-4	14-864	84	3-2
12E	57	2-1	14-3320-1	166	1-3	14-756	167	4-2	14-864	167	1-2
12KM	57	1-1	14-3330	85	1-1	14-756	167	4-5	14-864B	85	2-1
130	47	1-3	14-3330-1	166	1-3	14-758	85	4-3	14-865	84	3-3
1306	71	2-1	14-4180-0	87	3-2	14-760	84	2-3	14-865	167	1-4
131-91309	109	2-6	14-4180-0	169	1-2	14-763	84	1-2	14-865	168	1-5
131-91606	109	2-6	14-421	87	3-3	14-763	165	1-4	14-866	86	2-1
131-92802	109	2-5	14-421	169	1-2	14-764	167	1-1	14-866	167	4-3
13116702	10	2-5	14-431	88	5-2	14-764	84	1-2	14-866	167	4-6
13150503	09	4-5	14-442	87	3-4	14-765	84	1-4	14-866B	86	2-6
13150602	09	4-4	14-442	169	1-3	14-765	167	1-3	14-868	86	2-2
13150701	09	1-6	14-443	87	3-4	14-765	168	1-4	14-870	86	3-3
13191309	161	3-4	14-443	169	1-3	14-766	85	4-4	14-871	84	4-2
13191408	109	4-2	14-465	87	4-1	14-766	167	4-2	14-873	84	2-5
13191606	161	3-4	14-465	169	1-4	14-766	167	4-5	14-874	84	2-5
13192406	109	4-2	14-480	171	1-1	14-768	85	4-3	14-875	85	2-2
13192802	161	2-4	14-496	87	4-2	14-771	85	4-5	14-876	84	4-4
13193206	109	4-1	14-496	170	1-3	14-772	85	4-5	14-8780-1	85	3-3
134-60803	09	2-3	14-497	87	4-3	14-773	85	4-5	14-8790-1	85	3-4
134-61801	10	2-2	14-497	170	1-3	14-774	85	4-5	14-880	166	1-2
13458500	15	1-2	14-497.N	88	3-1	14-775	85	4-5	14-880	84	4-3
135-15507	65	1-1	14-497.N	171	2-1	14-776	86	2-3	14-881	85	3-6
135-15507	83	1-2	14-553	87	2-6	14-777	86	2-3	14-882	85	3-5
135-15564	64	2-1	14-553	166	1-5	14-779	86	2-4	14-883	84	3-1
135-15564	83	1-1	14-554	87	2-6	14-784	85	4-6	14-884	84	2-2
135-18600	128	3-2	14-563	87	2-5	14-785	85	4-6	14-885	84	2-2
135-18709	128	3-3	14-563	166	1-4	14-786	86	1-1	14-886	84	2-2

PARÇA KODU / PART NO.	SAYFA / PAGE	SIRA / LINE	PARÇA KODU / PART NO.	SAYFA / PAGE	SIRA / LINE	PARÇA KODU / PART NO.	SAYFA / PAGE	SIRA / LINE	PARÇA KODU / PART NO.	SAYFA / PAGE	SIRA / LINE
14-887	84	1-6	146572-001	105	4-3	149-677-001	151	1-5	15-756	167	6-2
14-888	84	2-1	146572-001	152	2-4	149-691-001	151	2-3	15-758	167	6-1
14-889	84	3-5	146573-001	105	4-5	149-691-001	105	1-3	15-760	112	3-1
14-890	166	1-1	146573-001	152	2-5	149-938-001	151	2-4	15-805	110	1-3
14-890	165	1-5	146574-001	153	2-1	149-938-001	105	1-4	15-805	165	2-4
14-890	84	3-6	146574-001	106	1-1	149-948-001	105	1-2	15-805	168	2-3
14-890H	84	3-6	146577-001	105	3-5	149-948-001	152	2-1	15-805	111	2-1
14-891	84	4-1	146577-001	105	4-4	149-954-001	76	2-5	15-806	110	1-4
14-891	165	1-5	146577-001	105	3-3	149-954-001	152	1-1	15-807	110	1-1
14-891	166	1-1	146577-001	105	4-6	15-024	172	2-2	15-807	111	2-3
14-892	85	2-3	146577-001	153	3-1	15-024	113	3-1	15-807	165	2-4
14-896	84	4-5	146577-001	152	3-3	15-024.A	113	4-1	15-807	168	2-2
14-897	84	4-5	146577-001	152	3-2	15-024.A	173	2-1	15-808	109	4-6
14-929	86	3-1	146577-001	152	3-4	15-034	173	2-2	15-808	110	1-2
14-930	86	3-2	146577-001	106	1-2	15-034	114	1-1	15-808	168	3-1
14-D 1/8x11	88	2-2	146730-001	76	3-5	15-034.A	114	2-1	15-809	110	2-3
14-D 1/8x11	170	1-1	146730-001	152	1-2	15-034.A	174	2-1	15-811	167	5-3
14-D 1/8x17	88	5-1	146731-001	76	3-5	15-046	170	2-4	15-811	111	2-5
14-D 1/8x17	171	1-3	146731-001	152	1-2	15-046	113	1-2	15-812	111	2-6
140135	91	4-3	146732-001	76	3-5	15-047	113	1-2	15-812	167	6-4
140242-101	02	3-3	146732-001	152	1-2	15-047	170	2-4	15-813	167	5-3
14041206	40	1-1	146733-001	76	3-5	15-11T	170	2-2	15-814	167	6-3
140888-001	02	4-1	146733-001	152	1-2	15-11T	112	4-1	15-823	109	4-5
141-03006	73	2-1	146734-001	77	1-1	15-17T	113	2-1	15-823	168	2-1
141-03253	73	2-1	146735-001	77	1-1	15-17T	172	2-1	15-836	111	4-5
141-03253	74	1-1	146736-001	77	1-1	15-301	166	3-3	15-837	111	4-6
141-03352	73	2-1	146744-001	105	4-4	15-301	112	2-2	15-843	165	3-4
141-03352	74	1-1	146744-001	105	3-3	15-315	112	2-3	15-843	111	2-2
141-03659	73	2-1	146744-001	105	3-5	15-318	112	2-4	15-844	165	3-4
141-03659	74	1-1	146744-001	152	3-2	15-361	112	2-1	15-844	111	2-4
141-09607	66	2-1	146748-001	105	3-2	15-361	166	2-3	15-853	111	3-5
141509-101	05	3-3	146748-001	152	2-2	15-418	112	3-4	15-854	111	3-6
141541-001	05	4-2	146773-001	152	5-3	15-4180-0	169	2-2	15-855	111	3-



PARÇA KODU / PART NO.	SAYFA / PAGE	SIRA / LINE	PARÇA KODU / PART NO.	SAYFA / PAGE	SIRA / LINE	PARÇA KODU / PART NO.	SAYFA / PAGE	SIRA / LINE	PARÇA KODU / PART NO.	SAYFA / PAGE	SIRA / LINE
152686-201	72	2-1	166-07707 (C-1)	14	1-4	179630-92	184	5-1	201230C/20552A	179	4-2
152686-201	73	1-1	166-07806 (C-2)	14	1-5	179630-920	181	5-4	201230C/208050A	133	1-4
152897-201	62	1-1	166150-001	78	1-1	179630-920	182	5-1	201230C/208050A	179	4-6
152897-201	04	2-2	166150-001	78	1-1	179630-920	143	1-1	201230C/210370	183	4-2
152901-001	04	1-4	166150-001	78	1-1	18-025	173	6-1	201230C/210370	133	3-3
152901-001	62	1-1	17-0064-5-849	40	4-2	18-025	172	6-2	201230C/210371	133	3-3
152904-001	62	1-1	17-0064-5-852	40	4-2	18-033	173	6-2	201230C/210371	183	4-2
152905-001	62	1-1	17-0064-5-854	40	4-2	18-033	174	6-1	201230C/210371	133	4-1
152905-001	04	1-6	17-0064-5-855	40	4-2	18-11T	170	6-2	201230C/210374	183	4-2
152906-101	04	1-5	17-0064-5-856	40	4-2	18-17T	172	6-1	201230C/210374	184	4-2
152906-101	62	1-1	17-0064-5-858	40	4-2	18-4180-1	169	6-1	201230C/210374	133	4-1
152981-001	04	2-3	17-0064-5-863	40	3-6	18-4210-1	169	6-1	201230C/210503	184	4-2
152981-001	62	1-1	17-0064-5-864 3/5CA	40	3-4	18-4420-0	169	6-2	201230C/210503	133	4-1
152995-001	62	1-1	17-0064-5-864 3/5CB	40	3-5	18-4430-0	169	6-2	201230C/2055250	133	2-2
152995-001	79	1-2	17-0064-5-951	40	4-2	18-4650-1	169	6-3	201230C/2055250	181	4-5
153219-001	04	2-1	17-0460-1	131	2-1	18-4800-1	171	6-1	201230C/2103710	133	2-3
153219-001	62	1-1	17-0460-1	170	3-4	18-4960-1	170	6-3	201230C/2103710	182	4-2
153220-001	62	1-1	17-0470-1	131	2-1	18-4970-1	170	6-3	201308	23	2-1
153222-001	62	1-1	17-0470-1	170	3-4	18-4970-1	171	6-2	2014738/301433	132	4-3
153596-001	62	1-1	17-11T	131	1-1	18-D 1/8x11	170	6-1	2014738/301433	179	4-3
153597-001	62	1-1	17-11T	170	3-2	18-D 1/8x17	171	6-3	202142-0-10	24	4-2
153598-001	62	1-1	17-17T	131	2-3	1802	37	3-1	202143-0-10	25	1-3
154568-001	03	2-3	17-17T	141	3-3	181716-001	150	4-2	202146-0-10	24	1-1
154568-101	03	4-6	17-17T	172	3-1	181716-001	139	2-5	202194-0-11	26	1-3
154569-001	03	4-4	17-17T	172	4-1	181722-001	139	2-6	202295	21	2-2
154575-001	03	2-2	172020201	209	1-5	183954-001	150	4-3	2022950	21	2-5
155103-001	64	1-1	172020226	209	2-1	183954-001	139	2-3	202403	91	4-2
155459-001	125	1-4	17-3010-1	130	3-3	183978-001	139	2-4	202451	23	2-2
155459-001	151	3-3	17-3610-1	130	3-4	183978-001	150	4-1	202499E1	182	1-3
155461-001	125	1-5	17-3610-1	166	4-3	19-025	173	5-1	202527A	22	1-4
155461-001	151	3-4	17-3710-1	169	3-2	19-025	172	5-2	202546E	176	1-5
155722-001	76	1-5	17-3710-1	169	3-2	19-033	173	5-2	202546E	179	1-1
155722-001	151	1-1	17-3750-1	130	4-3	19-033	174	5-1	202546E	92	1-2
155851-001	76	1-6	17-3750-1	169	3-2	19-11T	170	5-2	202546E1	92	1-2
155851-001	151	1-2	17-3890-1	130	4-4	19-17T	172	5-1	202546E1	182	1-2
155853-001	76	2-1	17-3890-1	165	3-3	19-4140-1	171	5-1	202554E	92	3-4
155855-001	76	2-2	17-3900-1	169	3-3	19-4180-1	169	5-1	202554E	177	1-2
155855-001	151	1-3	17-3900-1	130	4-4	19-4210-1	169	5-1	202554E	179	1-5
155857-001	76	2-3	17-3930-1	130	4-5	19-4420-0	169	5-2	202554E-H	92	3-4
155857-001	151	1-4	17-3930-1	169	3-4	19-4430-0	169	5-2	202554E1	182	1-3
156036-001	105	3-4	17-3960-1	131	1-2	19-4650-1	169	5-3	202570	22	1-5
156036-001	152	2-3	17-3960-1	170	3-3	19-4960-1	170	5-3	202617	92	1-1
156150-001	62	1-1	17-3970-1	131	1-2	19-4970-1	170	5-3	202617	176	1-3
156150-001	77	4-5	17-3970-1	170	3-3	19-4970-1	171	5-2	202618	92	1-1
156151-001	62	1-1	17-3970-1A	171	3-2	19-D 1/8x11	170	5-1	202618A	92	1-3
156151-001	77	4-6	17-4780-1	131	1-3	19-D 1/8x17	171	5-3	202618A	179	1-3
156152-001	62	1-1	17-4780-1	171	3-1				202675	92	3-5
156152-001	77	4-6	17-5320-1	166	5-4	200954	91	4-3	202675	176	1-4
157	30	4-5	17-5630-1	130	3-5	200959	21	3-4	202702	92	3-5
159274-001	06	1-1	17-5630-1	166	4-4	200971	22	1-3	202702	176	1-4
159276-001	06	1-2	17-5810-1	130	4-2	201121A	22	1-6	202702	176	1-4
159540-001	03	4-1	17-5810-1	169	3-1	201121A0	22	2-2	20271	34	1-6
159541-001	03	3-6	17-760-1	130	4-1	201121ANS	22	2-1	202733	117	1-2
159575-001	125	2-1	17-7620-1	130	3-6	201127	21	2-4	202734	117	1-1
159575-101	152	3-1	17-7620-1	165	4-4	201152E/201155C	132	4-2	202799/205525	133	3-6
159799-001	03	4-5	17-7680-1	130	3-1	201152E/201155C	176	4-3	202799/205525	184	4-1
159915-001	03	4-2	17-7680-1	165	4-5	201152E/201155C	178	4-6	202799/210371	133	3-4
164-01002	13	4-4	17-7680-1	166	4-1	201152E/277103	133	3-5	202799/210371	183	4-3
164-03008	13	4-5	17-7690-1	130	3-2	201152E/277103	183	4-4	202799/210372	133	3-4
164-16109	14	2-1	17-7690-1	165	4-5	201152E/277115	133	3-5	202799/210372	183	4-3
164-18600	14	1-6	17-7690-1	166	4-1	201152E/277115	183	4-4	202893	21	2-1
164-18709	14	2-2	17-7690-1	166	4-2	201152E0/201155C0	133	2-1	202932-0-10	24	4-4
16409906	14	2-4	17-D 1/8x11	130	4-6	201152E0/201155C0	182	4-1	202983	92	4-1
164178	103	1-2	17-D 1/8x11	170	3-1	201230C/201224B	132	4-4	202983	180	1-1
164550	30	2-2	17-D 1/8x17	131	2-2	201230C/201224B	176	4-6	203010-0-10	25	1-4
164728	30	1-5	17-D 1/8x17	171	3-3	201230C/201224B	179	4-1	203012-0-10	24	1-6
1650004-229	31	3-1	179458-05	22	4-6	201230C/201310A	176	4-4	203066-0-10	24	4-5
166-07301	13	4-6	179459-05	22	4-5	201230C/201396B	133	1-2	203069-0-10	24	2-4
166-07400	14	1-1	179630-92	142	4-1	201230C/201396B	176	4-4	203144-0-10	24	1-4
166-07509 (B-1)	14	1-2	179630-92	185	6-1	201230C/205525	133	1-3	203759-0-10	25	1-5
166-07608 (B-2)	14	1-3	179630-92	183	5-2	201230C/205525	177	4-1	203783-0-10	24	4-3

PARÇA KODU / PART NO.	SAYFA / PAGE	SIRA / LINE	PARÇA KODU / PART NO.	SAYFA / PAGE	SIRA / LINE	PARÇA KODU / PART NO.	SAYFA / PAGE	SIRA / LINE	PARÇA KODU / PART NO.	SAYFA / PAGE	SIRA / LINE
204039B	92	4-6	204634	147	1-5	204729B16F	116	1-4	208059	178	3-1
204039B	177	1-4	204659	147	1-6	204729B16F	179	3-3	208059	177	3-5
204042	147	1-3	204674	115	4-4	204730	115	4-1	208059	177	3-4
204161	21	2-6	204674	115	3-4	204730	177	2-1	208059	115	2-6
2041610	21	3-1	204674	115	3-6	204730	179	2-2	208059	115	2-4
204161A	21	3-2	204674	179	3-1	204730-BF	115	3-1	208059	115	1-4
204248B	180	3-5	204674	116	1-4	204730-BF	176	2-2	208059	115	1-2
204248B	115	2-4	204674	116	2-2	204730-BF	178	2-6	2080590	116	3-4
204248B	115	1-2	204674	176	3-2	204730-BF	115	3-3	2080590	116	3-6
204248B	177	3-4	204674	176	3-3	204730-BFO	116	4-1	2080590	182	3-4
204248B	178	3-1	204674	176	3-4	204730-BFO	182	2-1	2080590	183	3-1
204248B0	116	3-4	204674	177	3-2	2047300	116	4-5	208060	181	3-3
204248B0	182	3-4	204674	178	3-5	2047300	181	2-4	208060	115	1-6
204294B	92	4-6	204674	179	3-3	204730A16F	116	1-3	208060	177	3-6
204294B	177	1-4	204674	179	3-5	204730A16F	179	2-3	208060	178	3-4
204351	21	3-6	204674	179	3-6	204731A	92	1-5	208060	180	3-4
204360A	93	1-1	204674	115	3-2	20491	33	3-6	2080600	116	3-2
204360A	178	1-1	2046740	116	4-2	204931	178	3-2	2080600	182	3-3
204360A/204361A	178	1-1	2046740	116	4-4	204931	181	3-2	208061	115	2-2
204360A/204361A	180	1-5	2046740	182	3-1	204931	115	2-2	208061	178	3-2
204360A1	93	1-1	2046740	182	3-2	204939	93	1-5	208061	181	3-2
204360A1	182	1-5	204675A	115	4-4	204939	178	1-2	208063	115	2-3
204361A	93	1-1	204675A	115	4-6	204940	93	1-5	208063	177	3-4
204361A	178	1-1	204675A	176	3-4	204940	181	1-2	208063	178	3-1
204366	93	1-2	204675A	177	3-2	204941	93	1-5	208063	180	3-5
204366	177	1-5	204675A	177	3-3	204941	178	1-2	208063	115	1-2
204366	180	1-3	20467								



PARÇA KODU / PART NO.	SAYFA / PAGE	SIRA / LINE	PARÇA KODU / PART NO.	SAYFA / PAGE	SIRA / LINE	PARÇA KODU / PART NO.	SAYFA / PAGE	SIRA / LINE	PARÇA KODU / PART NO.	SAYFA / PAGE	SIRA / LINE
2082150	116	3-3	208730/208731	132	4-5	209508-45	179	1-6	210840	93	2-1
2082150	182	2-4	208730/208731	176	4-5	209509-25F	116	2-1	210845	93	2-2
208217	177	2-4	208730/208731	177	4-2	209509-25F	179	3-6	210846	93	2-2
208217	178	2-4	208730/208731	179	4-5	209668	147	2-2	210847	93	2-2
208217	181	2-1	208730/208732	132	4-5	209669	147	2-5	210848	93	2-2
208217	115	1-3	208730/208732	177	4-2	209669A	147	2-6	210868	93	2-3
2082170	116	3-5	208730/208732	179	4-5	209670	142	2-1	2109000	122	3-3
2082170	183	2-1	2087300/2087321	133	2-4	209670-92	142	3-1	2109000	200	2-4
208218	180	2-3	2087300/2087321	182	4-3	209670-92	176	5-3	2109000	123	1-1
208218	116	1-1	208905	142	2-2	209670-92	176	5-5	2109001	122	3-4
208219	177	2-5	208905	176	5-4	209670-92	177	5-1	2109001/2109052	123	1-2
208219	178	2-5	208905	177	5-2	209670-92	178	5-5	2109001/2109067	200	3-4
208219	180	2-4	208905	179	5-2	209670-92	179	5-1	2109005	200	2-6
208219	181	2-3	208905	180	5-1	209732	92	1-6	2109005	122	4-3
208219	115	1-5	208905A92	142	3-2	209732	180	1-2	2109005	122	4-1
2082190	116	3-1	208905A92	180	5-2	209740-16F	180	3-2	2109006	122	3-6
2082190	182	2-3	208906A92	142	3-3	209740-16F	116	1-5	2109006/2109052	122	4-4
208224	115	2-3	208906A92	179	5-3	209741-16F	180	3-2	2109006/2109067	200	3-5
208225	115	2-5	208909	142	2-3	209741-16F	116	1-6	2109006/2109067	122	4-2
208225	178	2-3	208909	177	5-3	209742-16F	116	1-5	2109007	200	2-5
208393	21	4-2	208909	178	5-2	209742-16F	180	2-2	2109007	122	3-5
208501	132	3-3	208909B92	142	3-4	21-3003	36	4-4	2109050	123	1-3
208501	177	4-4	208909B92	180	5-3	21-4001	36	3-4	2109051/2109052	123	1-4
208501	180	4-3	208909B92	181	5-2	2100167	32	3-1	2109067	122	3-4
208502	132	3-5	208910	142	2-4	2101155	35	1-4	2109067	122	3-6
208502	178	4-1	208910	178	5-1	2101156	35	1-3	2109100	145	2-3
208502	178	4-3	208910	178	5-3	2101220	34	4-5	2109100	200	5-2
208502	180	4-5	208910B92	142	3-5	2101221	34	4-6	2109101	145	2-4
208504	132	3-4	208910B92	180	5-4	2107032	137	1-1	2109102	145	3-1
208504	177	4-5	208910B92	181	5-1	2107032	200	4-4	2109110	145	3-2
208504	180	4-4	208911	115	4-1	2107100	137	2-3	2109112	145	3-3
208506	132	3-6	208911	177	3-1	2107102	137	2-4	2109120	145	3-4
208506	178	4-4	208911	179	3-2	2107300	137	1-3	2109122	145	3-5
208506	181	4-1	2089110	116	4-6	2107300	200	4-5	2109132	145	3-6
208506S	132	4-1	2089110	181	3-4	2107301	200	4-6	210980	93	2-4
208508	132	3-1	208912	115	4-2	2107301	137	1-4	210981	93	2-4
208508	178	4-2	208912	177	3-1	2107308	137	1-6	210982	93	2-4
208508	181	4-2	208912	179	3-2	2107309	137	1-6	210986	93	2-5
208525	132	4-2	2089120	116	4-6	2107310	137	1-5	210987	93	2-5
208525	132	4-3	2089120	181	3-4	2107311	137	1-5	2110305	32	3-2
208525	132	4-4	208914	142	2-5	210755	22	2-5	2111055	35	1-2
208525	132	4-5	208955	132	3-6	210783	92	2-1	2111056	35	1-1
208525	132	4-6	208955	178	4-4	210784	92	2-1	2111407-553-A	31	1-2
208525	133	1-1	208955	181	4-1	210796	92	2-2	2111407-553-B	31	1-3
208525	133	1-2	208965	142	2-6	210797	92	2-2	2111417-556-B	31	2-2
208525	133	1-3	208965	178	5-4	210799	92	2-3	2114012	35	2-2
208525	133	1-4	208965B92	142	3-6	210800	92	2-3	2114013	35	2-1
208525	133	1-5	208965B92	181	5-3	2108000	99	3-2	211662	22	2-6
208525	133	1-6	209009	147	2-3	2108000	200	1-4	211662A	22	3-1
208525	176	4-3	209340-2-01	25	2-4	2108002	99	3-3	2119000/2119015	122	4-6
208525	176	4-4	209341-0-00	25	4-4	2108002	200	1-5	2119002	122	4-5
208525	176	4-5	209341-0-10	25	2-2	2108003	99	3-4	2120000708	18	3-4
208525	176	4-6	209342-2-01	25	4-3	2108004	99	4-6	2120000715	18	2-3
208525	177	4-1	209344-2-00	24	3-3	2108005	99	4-6	212010010	18	2-4
208525	177	4-2	209347-2-01	25	3-2	2108006	100	1-2	2121107	33	4-1
208525	177	4-3	209348-0-00	25	4-5	2108008	99	3-5	2121111	32	3-3
208525	178	4-6	209348-0-10	24	4-6	2108017	99	3-1	212182/201310A	133	1-6
208525	179	4-1	209350-0-10	25	1-6	210804	92	4-2	212182/201310A	180	4-1
208525	179	4-2	209351-2-01	25	3-4	210805	92	4-2	212182/210371	133	1-5
208525	179	4-3	209352-0-00	25	4-6	2108050	100	2-5	212182/210371	179	4-4
208525	179	4-4	209352-0-10	25	1-2	2108052	100	2-6	2122207-113	36	1-2
208525	179	4-5	209354-0-10	25	2-1	210806	92	4-3	21261011	50	4-1
208525	179	4-6	209355-2-01	25	3-3	2108062	100	1-5	213-89200	15	4-4
208525	180	1-1	209356-0-00	25	1-1	2108064	100	1-6	213-89309	15	4-5
208525	180	4-2	209357-2-01	25	4-2	2108076	100	2-6	213108	21	4-3
208648	93	4-1	209416-25F	179	3-6	210809	92	4-4	213108A	21	4-4
208648	178	1-5	209416-25F	116	2-2	210810	92	4-4	213111-60	92	3-1
208648	181	1-3	209417A25F	116	2-1	2108100	99	3-6	2150256	33	3-3
208649	132	3-2	209417A25F	179	2-6	210837	93	2-1	2157057	137	2-1
208649	178	4-5	209425-2-01	25	3-5	210838	93	2-1	2157058	137	2-1
208649	181	4-4	209508-45	92	3-6	210839	93	2-1	2157086	137	1-2

PARÇA KODU / PART NO.	SAYFA / PAGE	SIRA / LINE	PARÇA KODU / PART NO.	SAYFA / PAGE	SIRA / LINE	PARÇA KODU / PART NO.	SAYFA / PAGE	SIRA / LINE	PARÇA KODU / PART NO.	SAYFA / PAGE	SIRA / LINE
2157116	137	2-2	257001B56	94	1-2	257090C56	94	2-2	257267-16F	188	2-3
2157118	137	2-2	257015B32	93	4-2	257090C56	187	1-3	257268-16F	118	4-1
2157310	137	2-5	257015B32	186	1-3	257097B56	94	2-3	257268-16F	188	2-4
2157315	137	2-6	257015B32	189	1-1	257097B56	189	1-3	257289-16F	118	4-3
2158003	100	1-3	257015B40	93	4-2	257097B64	94	2-3	257289-16F	189	2-1
2158011	100	1-4	257015B40	186	1-3	257097B64	189	1-3	257290-16F	118	4-5
2159102	145	4-1	257015B40	189	1-1	257100B40	95	1-3	257290-16F	189	2-1
2159111	145	4-2	257015B48	93	4-2	257100B40	190	1-1	257291-16F	119	1-1
2159112	145	4-3	257015B48	186	1-3	257100B48	95	1-3	257291-16F	189	2-3
2169113	145	4-4	257015B48	189	1-1	257100B48	190	1-1	257292-16F	119	1-1
21787	99	4-1	257016B46	186	1-4	257102B56	95	1-1	257292-16F	189	2-3
2200850222	18	4-2	257016B48	93	4-4	257102B56	190	1-2	257293-16F	119	1-3
2200850227	18	2-6	257016B56	93	4-5	257102B64	95	1-1	257293-16F	189	2-4
2206110119	18	2-2	257016B56	186	1-4	257102B64	190	1-2	257317A32	134	2-1
2206110120	18	4-4	257018A56	94	1-1	257102C56	95	1-2	257317A32	187	4-3
22100902372	18	4-1	257018A56	187	1-1	257102C64	95	1-2	257317A32	189	4-4
2210090242	18	1-4	257018B56	93	4-6	257105B56	94	2-4	257318A40	134	2-3
22195	32	3-4	257018B56	94	1-1	257105B64	94	2-4	257318A40	187	4-4
225-57458	70	2-1	257018B56	186	1-5	257108B56	94	2-5	257318A40	189	4-4
225-57557	70	2-1	257018B56-N	94	1-4	257108B64	94	2-5	257318A48	134	2-3
225-57557	13	3-4	257018B5601	94	1-1	257111C48	93	4-3	257318A48	187	4-4
225-57706	13	3-5	257018B56H	93	4-6	257203A16F	188	3-5	257318A48	189	4-4
225-57706	70	2-1	257018B64	94	1-1	257203A16F	118	2-2	257321A56	134	2-4
225-57805	70	2-1	257018B64	186	1-5	257206-16F	118	1-2	257321A56	188	4-1
225-57904	70	2-1	257018B64	189	1-2	257206-16F	186	3-3	257321A56	189	4-5
225-58001	70	2-1	257018C56	94	1-5	257207-16F	118	1-4	257321A64	134	2-4
225-58100	70	2-1	257018C64	94	1-5	257207-16F	118	1-6	257321A64	188	4-1
225-58209	70	2-1	257018D56	94	1-6	257207-16F	186	3-4	257321A64	189	4-5
225-58308	70	2-1	257020-60	94	3-1	257207-16F	187	3-1	257327A32	134	2-5
225-5											



PARÇA KODU / PART NO.	SAYFA / PAGE	SIRA / LINE	PARÇA KODU / PART NO.	SAYFA / PAGE	SIRA / LINE	PARÇA KODU / PART NO.	SAYFA / PAGE	SIRA / LINE	PARÇA KODU / PART NO.	SAYFA / PAGE	SIRA / LINE
257486-64	190	4-2	259203-16F	119	2-3	277029-920	143	1-4	277318-13	117	2-2
257491-60	134	1-6	259203-16F	190	2-2	277029-920	182	5-4	277318-13	185	3-2
257491-60	188	4-5	259215-16F	119	1-5	277029-920	183	5-1	277318-13	117	2-6
257499-3200	134	3-4	259215-16F	189	2-2	277030-92	185	5-4	277318-13	117	3-2
257500-40	143	1-5	259218A16F	119	3-2	277031-92	142	4-6	277318-13	117	3-6
257500-48	143	1-5	259234-16F0	118	3-4	277112/208651	184	4-3	277318-13	117	4-4
257501-56	143	1-6	259608B56	95	1-5	277112/208651	133	4-2	277318-13	117	4-6
257501-64	143	1-6	259614B56	95	1-6	277118	184	4-4	277318-13	183	3-2
257513-60	188	5-5	259620B56	93	4-5	277118	185	4-1	277318-13	183	3-3
257517-32	143	2-3	259620B5601	93	4-5	277118	133	4-3	277318-13	183	3-5
257517-32	186	5-3	259620B6401	93	4-5	2771180	133	2-5	277318-13	184	3-2
257517-32	187	5-4	26135	137	3-1	2771180	182	4-4	277318-13	184	3-3
257517-32	188	5-3	261416	47	5-1	277118A0	133	2-6	277318-13	185	3-1
257517-32	189	5-1	2615	47	2-1	277118A0	185	4-4	277318-130	117	4-2
257517-32	189	5-3	2631-T	46	3-3	277119	185	4-2	277318-130	117	2-4
257517-40	143	2-4	2631-T(TFL)	46	3-4	277119	133	4-4	277318A13	183	3-4
257517-40	186	5-3	2652197	07	3-6	2771190	133	3-1	277320	186	4-2
257517-40	187	5-5	268350010	08	2-3	2771190	182	4-5	277323-16	117	3-5
257517-40	188	5-3	268350030	08	2-4	277122	133	4-5	277323-16	186	3-2
257517-40	189	5-1	270-112	24	4-2	277122	185	4-3	277323-160	117	4-1
257517-40	189	5-3	270-112/1	25	1-3	2771220	133	3-2	277323-16F	184	3-3
257517-40	190	5-1	270-113	23	4-3	2771220	183	4-1	277324-16	117	3-6
257517-48	143	2-5	270-113/1	24	1-1	277149-40	185	5-5	277324-160	117	4-2
257517-48	186	5-3	27002	100	2-1	277149-400	133	4-6	277324-16F	184	3-3
257517-48	187	5-5	27004	100	2-1	277151-40	186	5-1	277325-16	117	3-5
257517-48	188	5-3	2701-P9-113/1	24	1-4	277151-400	134	1-1	277325-16	184	2-3
257517-48	189	5-1	274018-92B	133	3-3	277153-40	186	5-2	277325-16	186	2-2
257517-48	189	5-3	274018-92B	133	3-4	277153-400	134	1-2	277325-160	117	4-1
257517-48	190	5-1	274018-92B	133	3-5	277300-16F	183	3-2	277327-16	117	4-3
257518-48	143	2-6	274018-92B	133	3-6	277300-16F	183	3-5	277327-16	117	4-5
257518-48	186	5-4	274018-92B	183	4-2	277300-16F	117	1-3	277327-16	185	3-3
257518-48	188	5-2	274018-92B	183	4-3	277301-16F	117	1-4	277327-16F	185	3-1
257518-56	143	3-1	274018-92B	183	4-4	277301-16F	117	3-4	277328-16	117	4-4
257518-56	186	5-4	274018-92B	184	4-1	277301-16F	183	3-2	277328-16	117	4-6
257518-56	187	5-1	274018-92B	184	4-2	277301-16F	183	3-5	277328-16	185	3-1
257518-56	187	5-2	274018-92B	184	4-3	277301-16F	184	3-1	277329-16	117	4-5
257518-56	187	5-3	274018-92B	133	4-1	277302-16F	117	1-3	277329-16	185	2-2
257518-56	188	5-1	274018-92B	133	4-2	277302-16F	117	3-3	277329-16	185	2-4
257518-56	188	5-4	274018-92B0	133	2-1	277302-16F	183	2-2	277330-16	117	4-3
257518-56	189	5-2	274018-92B0	133	2-2	277302-16F	183	2-4	277330-16	185	2-1
257518-56	189	5-4	274018-92B0	133	2-3	277302-16F	184	2-1	277337-25	117	3-1
257518-56	190	5-2	274018-92B0	133	2-4	277303-16F	117	1-6	277337-25	185	3-2
257518-64	143	3-2	274018-92B0	181	4-5	277303-16F	117	2-2	277338-25	117	3-2
257518-64	186	5-4	274018-92B0	182	4-1	277303-16F	186	3-1	277338-25	185	3-2
257518-64	187	5-2	274018-92B0	182	4-2	277303-16F	117	2-5	277339-25	117	3-1
257518-64	188	5-1	274018-92B0	182	4-3	277303-16F	183	3-3	277339-25	185	2-3
257518-64	188	5-4	2768-112	24	4-4	277303-16F	184	3-2	277344	185	4-5
257518-64	189	5-2	277-112	25	1-4	277303-16F	185	3-4	277345	186	4-1
257518-64	189	5-4	277-113	24	1-6	277303-16F0	117	2-4	277500P30	92	2-5
257518-64	190	5-2	277000	22	2-4	277303A16F	183	3-4	277500P30	183	1-2
257542-56	190	5-3	277004	147	4-1	277304-16F	117	1-6	277500P30	183	1-5
257542-561	143	2-1	277005	147	3-6	277304-16F	117	2-2	277500P40	92	2-5
257542-64	190	5-3	277006	147	3-5	277304-16F	184	3-2	277500P40	183	1-2
257542-641	143	2-1	277007	147	3-3	277304-16F	117	2-6	277500P40	183	1-5
257567	147	3-2	277008	147	3-4	277304-16F	183	3-3	277502P15	92	2-4
257568	147	3-1	277009	21	3-5	277304-16F	183	3-4	277502P15	184	1-2
257573	22	3-3	277022-92	142	4-2	277304-16F0	117	2-4	277504R30	92	2-6
257573A	22	3-4	277022-92	184	5-2	277305-16F	117	1-5	277504R30	183	1-3
257574	22	3-5	277022-92	186	6-1	277305-16F	117	2-1	277504R40	92	2-6
259100-16F	119	2-2	277022-920	143	1-2	277305-16F	117	2-5	277504R40	183	1-3
259100-16F	190	3-1	277022-920	182	5-2	277305-16F	183	2-3	277504R40	185	1-5
259101-16F	119	2-4	277027-92	142	4-3	277305-16F	184	2-2	277504R50	92	2-6
259101-16F	190	3-2	277027-92	184	5-3	277305-16F	185	2-5	277504R50	183	1-3
259103-16F	119	1-6	277027-92	185	5-1	277305-16F	186	2-1	277504R50	183	1-4
259103-16F	189	3-2	277027-92	186	6-2	277305-16F0	117	2-3	277504R60	92	2-6
259106-16F	119	3-1	277027-921	143	1-3	277309-13	117	3-4	277504R60	183	1-4
259110-16F	119	2-5	277027-921	182	5-3	277309-13	184	3-1	277505R30	92	4-5
259110-16F	190	3-3	277028-92	142	4-4	277315-16F	117	3-3	277505R30	184	1-3
259128-16F0	118	3-3	277028-92	185	5-2	277315-16F	184	3-1	277505R40	92	4-5
259202-16F	119	2-1	277029-92	142	4-5	277318-13	117	1-4	277505R40	184	1-3
259202-16F	190	2-1	277029-92	185	5-3	277318-13	117	1-6	277505R40	184	1-4

PARÇA KODU / PART NO.	SAYFA / PAGE	SIRA / LINE	PARÇA KODU / PART NO.	SAYFA / PAGE	SIRA / LINE	PARÇA KODU / PART NO.	SAYFA / PAGE	SIRA / LINE	PARÇA KODU / PART NO.	SAYFA / PAGE	SIRA / LINE
277505R40	186	1-1	308030	23	1-3	3118026	102	2-5	3209004	123	4-3
277505R50	92	4-5	3100512	34	1-3	3118026	204	1-4	3209005	202	2-1
277505R50	184	1-3	3100513	34	2-5	3119020	204	2-3	3209005	123	4-3
277505R50	184	1-4	3101026	32	4-3	3119020	123	3-1	3209006	124	1-1
277505R60	92	4-5	3101028	33	4-5	3119021	123	3-1	3209007	124	1-1
277511S7000	92	2-5	3101465	33	4-4	3119021	204	3-3	3209008	201	3-4
277512P15	92	2-4	3101633	32	4-4	315507-0-00	24	2-3	3209008	123	4-2
277512P15	184	1-1	3101699	34	4-1	3158006	101	3-2	3209009	123	4-2
277513R40	93	2-6	3101700	34	4-2	3158012	101	3-3	3209009	201	2-4
277513R40	184	1-5	3101801	34	2-3	3158082	205	1-4	3209064	201	3-2
277513R40	186	1-2	3101802	34	2-4	3158082	101	3-2	3209064	202	3-2
277513R50	93	2-6	3106000	123	2-2	3158094	101	3-3	3209064	124	1-2
277513R50	184	1-5	3107273	138	2-6	3158094	205	1-3	3209065	124	1-2
277513R50-N	93	3-1	3107273	205	4-1	3159012	205	2-3	3209065	201	2-2
277516R50	93	3-3	3107274	138	2-7	3159019	205	2-2	3209065	202	2-2
277516R50	185	1-2	3107274	205	4-1	3159034	205	2-3	3209080	201	3-1
277516R60	93	3-3	3108002	102	1-3	3159034	205	2-2	3209080	123	3-2
277516R60	185	1-2	3108002	204	1-2	3159034/3159012	124	2-3	3209100	146	1-4
277517R40	93	3-2	3108003	102	1-3	3159034/3159019	124	1-3	3209101	146	1-4
277517R40	185	1-1	3108003	204	1-3	3159037	124	1-4	3209101	201	5-5
277517R50	93	3-2	3108130	100	3-3	3159037	124	2-4	3209102	146	1-4
277517R50	185	1-1	3108130	201	1-1	3159037	205	3-2	3209102	202	5-1
277518R40	93	3-5	3108131	100	3-3	32-2047-1-001	36	4-2	3209106	146	1-5
277518R40	185	1-4	3108131	201	1-1	32-2047-1-002	36	4-3	3209107	201	5-6
277519R40	93	3-6	3108132	100	3-3	320-16107	14	3-6	3209107	146	1-5
277524T50	93	3-4	3108132	201	1-1	320-18012	14	3-4	3209107	201	5-4
277524T50	185	1-3	3108133	100							



PARÇA KODU / PART NO.	SAYFA / PAGE	SIRA / LINE	PARÇA KODU / PART NO.	SAYFA / PAGE	SIRA / LINE	PARÇA KODU / PART NO.	SAYFA / PAGE	SIRA / LINE	PARÇA KODU / PART NO.	SAYFA / PAGE	SIRA / LINE
3507050-N	203	4-5	37472(HSS)	33	2-2	408-9102-01-A	09	1-3	5220TP85400	175	1-5
3507052-N	203	4-6	37483	99	2-4	410295	30	1-4	5220TP85480	91	3-6
3507052-N	138	1-4	37496	137	3-2	411088	30	3-3	5220TP85480	175	1-5
3507052-N	205	4-3	37514	33	2-3	412585	30	2-1	5220TP85560	91	2-6
3507054-N	138	1-5	37538	32	4-1	412749	30	1-3	5220TP85560	175	1-6
3507054-N	204	4-1	380006	53	3-1	42305	30	1-2	5220TP85560	175	1-3
3507060	204	4-5	39249A	31	4-3	42309	30	1-1	5220TP85561	175	1-3
3507060	138	1-2	39270A	31	4-5	46-1001-5-289	30	4-3	5220TP85561	91	2-6
3507064	138	2-5	39270D	31	4-6	46-1125-5-000	30	4-4	5220TP85640	175	1-6
3507064	204	4-6	39270E	32	1-1	46377	45	1-2	5220TP85641	91	2-4
3507064	205	4-1	39270K	32	1-2	4AG0030104	18	3-6	5222PF85400	132	1-5
3507064	205	4-2	39549	31	3-2	4AG0050103	18	3-5	5222PF85400	175	4-5
3507108	204	4-2	39549J	31	4-2	4AG0050104	18	2-5	5222PF85480	132	1-5
3507108	138	2-1	39549N	31	4-1				5222PF85480	175	4-5
3507111	138	2-1	39570	32	1-5	5000261	34	4-3	5222PF85560	132	1-4
3507111	204	4-3	39570J	32	2-1	5000262	34	4-4	5222PF85560	132	1-6
3508000	100	3-2	39570K	32	2-2	502670	30	3-4	5222PF85560	175	4-3
3508000	203	1-3	39570L	32	2-3	51009080	07	4-5	5222PF85640	132	1-6
3508001	100	3-2	396 351690	08	1-5	5100912	07	4-6	5222PF85640	175	4-6
3508001	203	1-4	3G-007016F	119	2-6	52-275	17	4-1	5222PF85641	132	1-4
3508002	101	2-1	3G0007016F1	190	2-3	52-288	17	4-2	5222PF85641	175	4-3
3508002	203	1-5	3Q00390356	190	4-3	5210TP04A63	90	3-1	5222PFL1400	132	2-1
3508003	101	2-2	3Q003903560	134	3-5	5210TP05C52	90	4-1	5222PFL1400	176	4-1
3508003	203	1-6	3Q00390364	190	4-3	5212TP0015	90	3-2	5222PFL1480	132	2-1
3508004	101	2-3	3Q003903640	134	3-6	5212TP0033	90	4-4	5222PFL1480	176	4-1
3508004	204	1-1			5212TP0035	90	3-6	5222PFL1560	132	2-2	
3508008	101	3-1	400-04255	15	3-3	5220DF42562	175	3-4	5222PFL1560	176	4-2
3508087	101	2-5	400-04301	83	3-3	5220DF42562	114	4-1	5222PFL1640	132	2-2
3508098	102	2-6	400-04311	15	3-4	5220DF85561	175	3-3	5222PFL1640	176	4-2
3508098	204	1-5	400-04350	82	2-2	5220DF85561	175	3-5	5222TP03400	91	2-3
3508099	204	1-6	400-04352	82	2-2	5220DF85561	114	4-3	5222TP03480	91	2-3
3508099	102	3-1	400-06574	74	1-1	5220DFL 1561	176	2-1	5222TP03640	91	2-3
3508100	102	3-1	400-06721	65	2-1	5220DFL 1561	176	3-1	5222TP11400	91	3-5
3508100	205	1-1	400-06721	83	2-1	5220FD42562	175	2-4	5222TP11480	91	2-1
3508101	102	3-1	400-06721	66	1-1	5220FD42562	114	3-5	5222TP11560	91	2-1
3508101	205	1-2	400-06725	66	1-1	5220FD85561	114	4-2	5222TP13562	91	3-4
3509004	203	2-2	400-06726	66	1-1	5220FD85561	175	2-3	5222TPL1400	91	3-1
3509004	204	2-1	400-08646	129	1-5	5220FD85561	175	2-5	5222TPL1400	176	1-1
3509004	124	2-1	400-08658	129	1-5	5220FDL 1561	114	4-4	5222TPL1480	91	3-1
3509005	124	2-2	400-11512	74	1-1	5220FDL 1561	176	2-1	5222TPL1480	176	1-1
3509005	203	3-2	400-12403	15	4-6	5220NC00400	142	1-4	5222TPL1560	91	3-2
3509005	204	3-1	400-12404	16	1-1	5220NC00400	175	5-5	5222TPL1560	176	1-2
3509036	124	3-3	400-14963	74	1-1	5220NC00400	176	5-1	5222TPL1640	91	3-2
3509036	204	2-5	400-23020	14	3-1	5220NC00480	142	1-4	5222TPL1640	176	1-2
3509036	205	2-1	400-26155	14	2-3	5220NC00480	175	5-5	5240PF0109	18	3-1
3509037	124	3-2	400-27553	82	2-1	5220NC00480	176	5-1	525C1-5-1	59	2-3
3509037	124	3-4	400-27554	82	2-1	5220NC00561	142	1-5	525C1-5-2	59	2-4
3509037	204	3-4	400-30934	82	4-3	5220NC00561	175	5-3	540012	209	1-3
3509037	205	3-1	400-33809	14	2-5	5220NC00561	175	5-4	540741	30	3-5
3509039	124	3-1	400-33814	14	2-6	5220NC00561	175	5-6	540760	30	3-6
3509039	204	2-4	400-38091	09	2-1	5220NC00561	176	5-2	544533	30	3-2
35285	32	3-6	400-38754	10	1-6	5220NC00641	142	1-5	544587	41	3-4
35286	33	4-2	400-39364	10	2-1	5220NC00641	175	5-3	544588	41	3-4
35334	100	2-4	400-42378	09	2-2	5220NC00641	175	5-4	544589	41	3-4
35796B	32	2-4	400-46301	79	3-1	5220NC00641	175	5-6	544593	41	3-5
35796C	32	2-5	400-46301-1	79	2-5	5220NC00641	176	5-2	544595	41	3-5
36200	103	4-1	400-46303	79	3-2	5220PF42561	132	1-3	544596	41	3-5
36210	103	4-1	400-46303-1	79	2-4	5220PF42561	175	4-4	544599	41	2-2
36224A	103	4-2	40015996	14	4-4	5220PF42641	132	1-3	544600	41	3-3
36250	31	4-4	40025949	16	2-2	5220PF42641	175	4-4	54782009	50	1-1
36270	32	1-3	40029004	15	1-1	5220TP00564	91	1-6	548066	41	3-2
36270B	32	1-4	40030932	68	1-1	5220TP00566	91	1-6	548752	41	4-2
36278D	23	3-2	40030933	68	1-1	5220TP00568	91	1-5	548753	41	4-2
36279	99	2-1	40030934	68	1-1	5220TP00646	91	1-5	548754	41	4-2
36304	99	4-5	40034923	14	3-2	5220TP03560	91	2-3	548755	41	4-2
36415	33	2-6	40044189	12	3-2	5220TP03563	91	2-4	548756	41	4-2
37231-033	36	4-5	40044190	12	3-4	5220TP42562	91	4-1	548757	41	4-2
37289	99	2-4	40050588	12	3-5	5220TP42562	175	1-4	548758	41	4-2
37469	33	2-4	40050589	12	3-3	5220TP42642	91	4-1	548759	41	4-2
37469(HSS)	33	2-4	40089755	12	2-1	5220TP42642	175	1-4	548760	41	4-2
37472	33	2-2	408-9101-01-B	09	2-4	5220TP85400	91	3-6	548761	41	4-2

PARÇA KODU / PART NO.	SAYFA / PAGE	SIRA / LINE	PARÇA KODU / PART NO.	SAYFA / PAGE	SIRA / LINE	PARÇA KODU / PART NO.	SAYFA / PAGE	SIRA / LINE	PARÇA KODU / PART NO.	SAYFA / PAGE	SIRA / LINE
548762	41	4-1	57-1020-1	110	4-2	57-232	165	2-1	6-91K	20	2-3
548763	41	4-1	57-1020-1	164	3-4	57-232	111	1-1	6031218P700	18	1-5
548764	41	4-1	57-105	110	2-6	57-232	111	1-3	6031314CS00	18	3-2
548765	41	4-1	57-105	110	3-6	572303	209	1-4	605340	39	3-5
548766	41	4-1	57-105	163	3-1	57-242	111	1-5	613140	35	4-1
548767	41	4-1	57-105	164	3-3	57-242	165	2-2	6200020	34	2-2
548768	41	4-1	57-106	110	2-6	57-3010-1	130	1-1	6200022	33	3-1
548769	41	4-1	57-106	163	3-1	57-3010-1	163	4-5	6200097	32	4-2
548770	41	4-1	57-107	110	4-2	57-3020-1	130	1-6	620800	100	1-1
548771	41	4-1	57-107	164	3-4	57-3020-1	164	4-4	620802	100	1-1
548804	39	3-6	57-108	110	4-2	57-3110-1	130	1-3	625780	08	1-3
548837	41	3-6	57-108	110	4-6	57-3110-1	164	4-1	625790	08	1-4
548838	41	3-6	57-108	164	3-4	57-3120-1	130	2-1	63318	137	4-2
548845	30	2-3	57-108	164	3-5	57-3120-1	164	4-4	63318	201	4-1
548851	30	2-4	57-108	165	3-1	57-3210-1	130	1-2	63318	202	4-3
548865	30	2-6	57-108	165	3-2	57-3210-1	164	4-2	63319	137	4-2
548886	41	2-3	57-108	165	3-3	57-3220-1	130	2-3	63319	201	4-1
548935	41	2-5	57-108	111	1-6	57-3220-1	164	4-5	63319	202	4-3
548936	41	2-1	57-108	111	1-4	57-3310-1	130	1-4	63320	201	4-1
548992	41	2-4	57-108	111	1-2	57-3310-1	163	4-6	63320	202	4-3
550449	30	1-6	57-1110-1	110	3-4	57-3320-1	130	2-2	63320	137	4-2
557 1677	39	1-3	57-1110-1	164	3-1	57-3320-1	164	4-6	6378-113	24	1-5
558 2406	39	4-1	57-1120-1	110	4-6	57-3410-1	130	1-5	64041-N	137	4-3
558 2407	39	4-1	57-1120-1	164	3-5	57-3410-1	164	4-3	64041-N	201	4-2
558 2408	39	4-1	57-1120-1	111	1-6	57-3420-1	130	2-4	64041-N	202	4-4
558 2409	39	4-1	57-1120-1	165	3-3	57-3420-1	165	4-1	64042-N	137	4-4
558 2410	39	4-1	57-115	110	3-2	57-3520-1	130	2-5	64042-N	202	4-5
558 2411	39	4-1	57-115	110	3-4	57-3520-1	165	4-2	643C1-41	56	1-1
558 2412	39	4-1	57-115	164	3-1	57-3620-1	130	2-6	643C1-43	56	1-1
558 2413	39	4-1	57-115	164	3-2	57-3620-1	165	4-3	643C1-47	56	1-1
558 2414	39	4-1	57-116	110	3-4	57-503	163	5-5			



PARÇA KODU / PART NO.	SAYFA / PAGE	SIRA / LINE	PARÇA KODU / PART NO.	SAYFA / PAGE	SIRA / LINE	PARÇA KODU / PART NO.	SAYFA / PAGE	SIRA / LINE	PARÇA KODU / PART NO.	SAYFA / PAGE	SIRA / LINE
71CL 1"(A)	55	2-5	85878000	50	3-1	93352	146	1-1	94909	203	4-2
71CL 1"(B)	55	2-5	8C125-21	44	1-3	93352	201	5-1	95-774853-05	21	1-4
71CL 1"(C)	55	2-5	BE	57	2-1	93352	201	5-3	95-774855-05	21	1-3
71CL 1/2"(A)	55	1-5	BE(TFL)	57	3-1	93352	202	5-2	95-774856-05	21	1-5
71CL 1/2"(B)	55	1-5	BEW	58	2-1	93352	203	5-1	95085	102	1-2
71CL 1/2"(C)	55	1-5	BEW(KO)	58	2-1	93352	203	5-4	95085	201	1-6
71CL 1/4"(A)	55	1-1	8KM	57	1-1	93352	204	5-5	95085	203	1-2
71CL 1/4"(B)	55	1-1	8KMW	58	1-1	93353	146	1-1	95089	201	4-6
71CL 1/4"(C)	55	1-1				93353	201	5-1	95089	137	4-5
71CL 1/8"(A)	55	2-4	901-1	48	3-1	93353	202	5-3	95089	203	4-2
71CL 1/8"(B)	55	2-4	901-2	48	3-2	93356	146	1-2	95234	101	4-1
71CL 1/8"(C)	55	2-4	90166	100	4-1	93356	203	5-5	95234	201	1-5
71CL 3/4"(A)	55	2-2	90167	100	4-1	93356	204	5-6	95234	203	1-1
71CL 3/4"(B)	55	2-2	90556	101	4-6	93357	146	1-2	95238	201	4-5
71CL 3/4"(C)	55	2-2	90557	101	4-6	93357	201	5-2	95238	137	3-5
71CL 3/8"(A)	55	1-3	91-012609-XP	104	4-1	93357	202	5-5	95238	203	4-1
71CL 3/8"(B)	55	1-3	91-014046-05	20	4-4	93357	203	5-2	95260	101	4-3
71CL 3/8"(C)	55	1-3	91-140726-01	20	3-5	93357	203	5-6	95261	101	4-4
71CL 5/16"(A)	55	1-2	91-141518-25	104	4-2	93357	204	5-2	95262	101	4-4
71CL 5/16"(B)	55	1-2	91-141911-01	20	4-2	93357	204	5-4	95276	33	4-3
71CL 5/16"(C)	55	1-2	91-150625-24	104	2-1	93357	205	5-1	95277	33	1-1
71CL 5/8"(A)	55	2-1	91-150625-007	104	2-2	93357	205	5-3	95278	102	2-3
71CL 5/8"(B)	55	2-1	91-150728-23/004	104	2-1	93358	146	1-2	95279	102	2-3
71CL 5/8"(C)	55	2-1	91-150728-23/007	104	2-2	93358	202	5-4	95399	34	3-2
71CL 7/16"(A)	55	1-4	91-150868-24	104	1-2	93358	202	5-6	95493	100	3-6
71CL 7/16"(B)	55	1-4	91-150868-24	103	4-3	93358	203	5-2	95493	202	1-4
71CL 7/16"(C)	55	1-4	91-150876-93	103	4-3	93358	204	5-1	95580	137	3-3
71CL 7/8"(A)	55	2-3	91-150877-91	103	4-4	93358	204	5-3	95581	137	3-3
71CL 7/8"(B)	55	2-3	91-150879-91	104	1-2	93358	204	5-4	95582	137	3-3
71CL 7/8"(C)	55	2-3	91-150880-91	104	1-1	93358	205	5-2	95587	137	3-4
71CL 9/16"(A)	55	1-6	91-150882-25	103	4-4	93394	124	3-5	95587	201	4-4
71CL 9/16"(B)	55	1-6	91-150882-25	104	1-1	93395	124	3-6	96-700535-05	20	1-4
71CL 9/16"(C)	55	1-6	91-150913-04-001	104	3-2	93396	124	4-1	96-700591-05	20	1-5
73436	51	1-1	91-150913-04-002	104	3-1	93397	124	4-2	9E	57	2-1
743C1-28	59	1-4	91-164726-93/003	143	3-3	93410	100	3-4	9EW	58	2-1
743C1-29	59	1-3	91-164727-X4	143	3-4	93417	100	3-4	9EW(KO)	58	2-1
745339100	07	3-1	91-165505-05	20	4-5	94210	101	4-2	9KM	57	1-1
745339110	07	3-2	91-168498-X5	208	4-2	94211	101	4-2	9KMW	58	1-1
745339120	07	2-3	91-168499-X5	208	4-1	94212	101	4-2			
745339130	07	2-4	91-188294-05	20	3-4	94217	137	3-6	A-113(6)	44	3-2
746	07	2-2	91-189140-05	20	3-3	94217	202	4-1	A-113(7)	44	3-3
746-60689	07	1-3	91-263139-05	21	1-1	94281	101	3-5	A-113(R)	44	3-1
746-60690	07	1-4	91-263294-05	20	4-6	94283	101	3-6	A-90-3	20	3-1
746-60691	07	1-5	91-263348-05	21	1-2	94283	202	1-1	A-90-7	20	3-2
746-60692	07	2-1	91-264240-05	20	4-3	94411	34	3-2	A105-2100	36	2-3
7E	57	2-1	91-264338-15	20	4-1	94417	34	3-3	A105-3100	36	2-4
7EW	58	2-1	91-710004-04	143	4-1	94800	100	3-6	A141D676H01	19	3-1
7EW(KO)	58	2-1	91-710004-04/002	143	3-5	94801	100	4-1	A4006-10H	56	2-1
7KM	57	1-1	91-710004-04/005	143	4-2	94801	201	1-4	A4006-12H	56	2-1
7KMW	58	1-1	91-710004-04/006	143	4-3	94801	202	1-5	A4006-13H	56	2-1
									A4006-7H	56	2-1
									A4006-8H	56	2-1
801-1	48	1-1	911-1/933-1	48	2-2	94801-FS	101	1-4	A4142655000	09	4-2
801-2	48	1-2	911-2/933-2	48	2-3	94801-L-DC(4.0)	100	3-5	A702	28	4-3
801214	51	1-2	91764	102	1-1	94801-L-DC(5.6)	100	4-1	A703	28	4-4
801217	52	6-1	91765	102	1-1	94801-L2-05	100	4-6	ABLE/HB-90-L	36	1-4
801220	51	4-1	928530-2-00	26	1-6	94801-LS	100	3-5	ABLE/HB-90-S	36	1-5
801222	52	5-1	928531-2-00	26	1-5	94801-LC	101	1-1	AC0516000000	208	2-5
801227	51	7-1	929197-0-02	26	1-4	94801-N	101	1-4	AC0517000000	208	2-6
801227	51	7-1	93170	100	3-1	94801-N-2	101	1-4	AC0518000000	208	3-1
801268	52	1-1	93170	202	1-3	94801-N-5	101	1-4	AF60874	175	3-1
801269	52	7-1	93171	100	3-1	94801B	101	1-5	AF60875	175	3-2
801274	52	1-1	93171	202	1-3	94801C	101	1-2	AF60875	114	3-4
801345	52	2-1	93172	100	3-1	94801C-LS	101	1-2	AF702	35	3-4
802-1	48	1-3	93172	202	1-3	94801D	101	1-3	AF703	35	3-5
802-2	48	2-1	93251	145	4-5	94801D-LS	101	1-3	AN02	26	4-2
80C1-59	44	1-1	93252	145	4-5	94802	202	1-6	AN12	26	4-3
80C1-61	44	1-2	93253	145	4-5	94802	100	4-1	AS-000288-00	136	4-3
81000669	36	1-3	93257	145	4-6	94802-LS	101	1-6	AS-000288-00	200	4-1
81000670	35	4-2	93351	146	1-1	94901	102	1-1	AS-001705-00	136	4-3
820C1-7	59	1-1	93351	201	5-1	94902	102	1-1			
820C1-8	59	1-2	93351	202	5-3	94902	203	1-2			
8303	52	5-1	93351	203	5-3	94909	137	4-5			

PARÇA KODU / PART NO.	SAYFA / PAGE	SIRA / LINE	PARÇA KODU / PART NO.	SAYFA / PAGE	SIRA / LINE	PARÇA KODU / PART NO.	SAYFA / PAGE	SIRA / LINE	PARÇA KODU / PART NO.	SAYFA / PAGE	SIRA / LINE
AS-001705-00	200	4-1	B1509-038-KB0	126	2-5	B2406-771-0A0	70	1-1	B2423-280-00A	68	1-1
AS-002970-00	136	4-2	B1509-038-KB0	163	4-4	B2408-761-000	15	1-5	B2423-280-00A	67	1-1
AS-002970-00	200	4-2	B1525-241-HA0	126	3-3	B2408-771-000-A	15	2-2	B2423-280-00B	64	2-1
AS-003073-00	136	4-2	B1528-380-0A0	14	4-6	B2408-771-000-A	69	2-1	B2423-280-00B	65	1-1
AS-003073-00	200	4-2	B1528-804-000A	10	2-4	B2408-771-000-A	70	1-1	B2423-280-00B	65	2-1
AS-003712-00	136	4-4	B1530-352-000	10	2-3	B2410-373-000	11	2-6	B2423-280-00B	66	1-1
AS-003712-00	200	4-3	B1552-781-000A	129	1-1	B2410-373-000	68	2-1	B2423-280-00B	66	2-1
AS-003713-00	136	4-4	B1552-781-0A0-A	129	1-1	B2410-373-000	69	1-1	B2423-280-00B	67	1-1
AS-003713-00	200	4-3	B1552-782-000	129	1-2	B2414-280-000	66	2-1	B2423-280-00B	67	2-1
AT0204000000	208	3-2	B1552-782-0A0-A	129	1-2	B2414-280-0A0	64	2-1	B2423-280-00B	68	1-1
AT020401	209	4-1	B1552-782-0A0-A(K)	129	1-3	B2414-280-0A0	65	1-1	B2423-280-00C	64	2-1
AT020402	209	4-3	B1552-783-000	129	1-4	B2414-280-0A0	65	2-1	B2423-280-00C	65	1-1
AT1303000000	210	2-1	B1552-783-0A0-A	129	1-4	B2414-280-0A0	66	1-1	B2423-280-00C	65	2-1
AT1303010000	210	2-2	B1613-380-800	107	1-1	B2414-280-0A0	67	2-1	B2423-280-00C	66	1-1
			B			B2414-280-0A0	67	1-1	B2423-280-00C	66	2-1
B	21	2-5	B1613-380-D00	107	1-2	B2414-280-0A0	68	1-1	B2423-280-00C	67	1-1
B(HSS)	21	2-5	B1613-380-D00	163	2-2	B2415-280-0A0	64	2-1	B2423-280-00C	67	2-1
B1103-380-B00	79	3-3	B1613-380-F00	107	1-3	B2415-280-0A0	65	1-1	B2423-280-00C	68	1-1
B1103-380-B00	163	1-1	B1613-380-F00	163	2-3	B2415-280-0A0	65	2-1	B2423-280-00D	64	2-1
B1103-380-D00	79	3-4	B1613-380-K00	107	1-4	B2415-280-0A0	66	1-1	B2423-280-00D	65	1-1
B1103-380-D00	163	1-2	B1613-380-K00	163	2-4	B2416-210-0A0	67	1-1	B2423-280-00D	65	2-1
B1103-380-F00	79	3-5	B1656-804-000	109	3-6	B2416-210-0A0	67	2-1	B2423-280-00D	66	1-1
B1103-380-F00	163	1-3	B1656-804-000	162	3-6	B2416-210-0A0	68	1-1	B2423-280-00D	66	2-1
B1103-380-K00	79	3-6	B1657-804-00C	162	2-6	B2416-210-DA0	66	2-1	B2423-280-00D	67	1-1
B1103-380-K00	163	1-4	B1657-804-00C	109	3-5	B2416-280-000	64	2-1	B2423-280-00D	67	2-1
B1130-026-000	10	3-2	B1657-804-00T	107	3-1	B2416-280-000	65	1-1	B2423-280-00D	68	1-1
B1131-026-000	10	3-3	B1657-804-00T	108	2-1	B2416-280-000	65	2-1	B2423-280-00E	64	2-1
B1136-357-A00	79	4-6	B1657-804-00T	108	4-5	B2416-280-000	66	1-1	B24		



PARÇA KODU / PART NO.	SAYFA / PAGE	SIRA / LINE	PARÇA KODU / PART NO.	SAYFA / PAGE	SIRA / LINE	PARÇA KODU / PART NO.	SAYFA / PAGE	SIRA / LINE	PARÇA KODU / PART NO.	SAYFA / PAGE	SIRA / LINE
B2426-280-00C	82	2-5	D095	119	3-6	D438	119	4-4	DST-05	08	3-5
B2426-771-000	70	1-1	D095	190	3-4	D438	191	3-1	DST-06	08	3-4
B2427-771-000	70	1-1	D095	191	3-4	D440	119	3-6	DT05	28	1-2
B2428-771-000	70	1-1	D1206	196	3-1	D440	190	3-4	DT06	28	1-1
B2429-771-000	70	1-1	D1206	121	1-4	D440	191	3-3	<b>E</b>		
B2529-373-000	82	2-3	D1207	121	1-6	D440	191	3-4	E0215R	98	1-1
B2702-377-000	69	1-1	D1207	196	3-2	D440	191	3-5	E0216R	98	1-4
B2703-377-0A0	69	1-1	D1207	196	3-4	D489	119	4-6	E0217R	98	1-4
B4108-352-00B	09	2-6	D1207	196	3-5	D489	192	3-1	E0225Q	98	1-2
B4108-352-00B(L)	09	2-5	D1207	121	2-6	D489	120	1-2	E0225R	98	1-2
B4108-352-00D	09	3-2	D1215	121	2-2	D490	120	1-4	E0225R	194	1-3
B4111-804-00A	10	1-3	D1215	195	3-3	D490	192	3-2	E0226P	98	1-5
B4111-804-00C	10	1-4	D1216	121	2-4	D502	119	4-6	E0226Q	98	1-6
B4111-804-00E	10	1-5	D1216	196	3-3	D502	120	1-2	E0226R	194	1-3
B4118-804-000	08	4-5	D1508-772-K00	129	1-3	D502	120	1-4	E0227Q	98	1-6
B4118-804-00C	08	4-6	D1511-771-KA0	129	1-3	D502	120	1-5	E0227R	194	1-3
B4121-052-A00	11	1-5	D1511-771-KA0-A	129	1-1	D502	120	2-1	E0235	98	1-3
B4121-522-000	11	1-6	D1511-772-KA0-A	129	1-2	D502	192	3-1	E137	98	2-5
B4121-522-000(W)	11	2-2	D1511-773-KA0-A	129	1-4	D502	192	3-2	E137P	98	2-6
B4121-522-000(W)(SKH9)	11	2-2	D2050-772-BA0-A	15	2-4	D502	192	3-3	E138	98	3-1
B4121-522-000(L)	11	1-6	D2056-772-B0B	70	2-1	D502	192	3-4	E139	98	3-2
B4121-522-000(SKS7)	11	1-6	D2101	194	2-3	D569	119	4-3	E139P	98	3-3
B4122-352-00A	09	1-4	D2101R	120	4-6	D569	191	3-1	E140	98	3-4
B4145-530-B00	11	2-1	D2107	140	3-6	D574	191	3-3	E141	98	3-5
B4401	36	2-1	D2107	194	3-2	D574	191	3-5	E1524	96	2-2
B4471	36	2-2	D2401-530-D00	12	1-1	D575	119	3-5	E1524	196	1-1
BE-438D(Light)	63	2-1	D2402-415-BA0	12	2-5	D575	190	3-4	E1525	96	2-2
BG127	28	3-4	D2402-555-BAB	12	2-4	D575	191	3-4	E1525	196	1-1
BG130D	28	3-3	D2402-555-BA0	12	2-3	D581	119	4-5	E1535	96	2-3
BK10F	28	4-1	D2404-530-D00	12	1-2	D581	120	1-1	E1816	96	4-1
BOM-101(4)	45	1-3	D2405-555-B00-B	11	4-5	D581	192	3-1	E1817	96	4-1
BT113072(10)	45	33	D2406-555-B00	12	2-6	D582	120	1-3	E1826	96	4-2
<b>C</b>			D2406-555-DOH	11	4-3	D582	192	3-2	E1826	196	1-2
CK-01G	50	4-1	D2406-555-DOH/M	11	4-4	D674	119	4-4	E1826H	96	4-3
CK-05G	50	1-1	D2408-555-CA0	13	1-6	D674	191	3-1	E1827	96	4-2
CK-11T	53	4-1	D2423-141-E00	13	2-4	D674	191	3-3	E1827	196	1-2
CK-16L	51	6-1	D2424-141-E00	13	2-5	D674	191	3-5	E1828	97	2-5
CK-17G	50	2-1	D2426-282-C00	65	2-1	D675	119	3-4	E1828	196	1-5
CK-17L	51	5-1	D2426-282-C00	82	3-2	D8. 15-11	82	3-1	E1836L	96	2-6
CK-31L	52	5-1	D2426-284-M00	66	2-1	D9012	198	2-1	E1837L	96	2-6
CK-33G	50	3-1	D290	119	4-1	D9012	197	2-2	E1846	96	4-4
CR26	27	2-1	D290	191	3-2	D9012	121	3-3	E1847	96	4-4
CR26H	27	1-3	D3161-555-BA0	13	2-3	D9104	197	2-1	E232	96	2-1
CR26J	27	1-2	D3216	120	2-4	D9104	121	3-1	E2324P	96	3-1
CRL03	27	1-4	D3216	120	3-2	D9108	121	3-2	E2325P	96	3-1
CRL03H	27	1-5	D3216	194	3-5	D9108	197	2-3	E2326P	97	1-5
CRL03J	27	1-6	D3216	195	3-2	D9112	121	4-1	E2625P	96	3-6
CRL04H	27	2-5	D3216	195	3-4	D9112	197	2-2	E2626P	194	1-2
CRL04J	27	2-4	D3216	193	3-4	D9112	198	2-1	E2626P	97	2-2
CRL09J	26	2-1	D3216	193	3-2	D9113	121	4-2	E2627P	97	2-2
CRL103	27	2-2	D3216	121	1-2	D9113	198	2-2	E2826P	97	2-3
CRL104	27	2-3	D3217	121	1-2	D9117A	199	2-1	E2827P	97	2-3
CT18-1	27	4-4	D3217	195	3-4	D9117A	122	1-1	E3024	195	1-4
CT19	27	4-3	D3222	120	4-2	D912	119	4-2	E3024	97	3-2
CT202	27	4-6	D3222	193	2-1	D912	191	3-2	E3025	97	3-2
CT203	27	4-5	D390	119	3-3	D9123A	122	1-2	E3025	195	1-4
CT270-112	25	2-3	D4206	120	3-4	D9123A	199	2-2	E3326	196	1-3
CT270-113/1	24	1-2	D4206	193	3-3	D9313	189	2-3	E3326	97	2-2
CT2768-112	25	2-6	D4206	194	3-1	D9313	121	4-3	E3326P	97	2-2
CT277-112	25	3-6	D4206	194	3-4	D9335-762-T00	15	2-5	E3327	97	2-2
CT277-113	24	2-1	D4206	194	3-4	D969	119	3-4	E3327	196	1-3
CT279-112	25	3-1	D4206	195	3-1	D971	120	1-6	E3327P	97	2-2
CT290-112	25	2-5	D4206	120	4-6	D971	192	3-3	E3524P	193	1-3
CT290-113	24	3-6	D4206	120	2-6	D972	120	2-2	E3524P	194	1-4
CT3100512	34	2-6	D4207	120	2-6	D972	192	3-4	E3524P	96	2-4
CT37469	33	2-5	D4207	120	4-6	DF85209	175	2-1	E3524R	96	3-2
CT39570	32	1-6	D4207	193	3-3	DF85209	114	3-1	E3525P	96	2-2
CTMAS-11012	10	4-5	D4207	194	3-4	DF86108	114	3-3	E3525P	96	2-5
CTMAS-11013	10	4-6	D4207	195	3-1	DF86108	175	2-2	E3525P	194	1-4
CTUT07	08	3-1	D438	191	3-2	DSK25	36	3-1	E3626P	194	1-1
<b>D</b>			D438	119	4-2	DSK27	36	2-6	E3626P	97	2-4

PARÇA KODU / PART NO.	SAYFA / PAGE	SIRA / LINE	PARÇA KODU / PART NO.	SAYFA / PAGE	SIRA / LINE	PARÇA KODU / PART NO.	SAYFA / PAGE	SIRA / LINE	PARÇA KODU / PART NO.	SAYFA / PAGE	SIRA / LINE
E3626P	97	2-4	E784	191	1-1	ER99	37	2-3	GP-012179-00	122	2-6
E3627P	97	2-4	E796	95	2-3	ERK35	37	2-6	GP-012180-00	122	2-5
E3727	97	3-4	E797	95	2-3	<b>F</b>			GP-012180-00	200	2-3
E3816P	96	4-5	E800	191	1-4	FBQ30	26	2-4	GP-012184-00	103	2-1
E3817P	96	4-5	E800	95	2-4	FC240	145	2-1	GP-012184-00	200	1-3
E3826	96	4-6	E800C	95	2-4	FC248	145	2-1	GP-012185-00	200	1-3
E3826	195	1-2	E800D	95	2-5	FC356	145	2-2	GP-012185-00	103	2-1
E3826-H	97	1-1	E804	95	3-6	FC364	145	2-2	GP-012186-00	200	2-3
E3826P	96	4-6	E804A	95	3-6	FD60828	114	3-2	GP-012985-00	200	3-3
E3826P	193	1-4	E805	95	3-6	FD60828	175	3-1	GP-012985-00	122	3-2
E3826P	194	1-5	E805	191	1-6	FD60842	114	3-4	GP-012986-00	122	3-1
E3826R	97	1-4	E805A	95	3-6	FD60842	175	3-2	GP-021183-00	103	3-1
E3827	96	4-6	E809	191	1-4	FD634D03	114	3-4	GP-031183-00	145	1-3
E3827	195	1-2	E809	191	1-5	FD634D03	175	3-2	GTP605D53	90	4-5
E3827P	96	4-6	E809	95	4-1	FR134	26	4-6	GTP605D63	90	4-5
E3827P	193	1-4	E809A	95	4-1	FR34	26	4-5	<b>H</b>		
E3827P	194	1-5	E810	191	1-4	FR34B	26	4-4	H1258	196	2-1
E3827R	97	1-4	E810	95	4-2	FR34H	27	1-1	H1258	121	1-3
E3836	97	1-2	E810A	95	4-2	FR40	26	2-5	H1259	121	1-5
E3837	97	1-2	E810L	95	4-3	FR40D	26	3-1	H1259	196	2-2
E3846	195	1-1	E8148	96	3-3	FR40J	26	3-3	H1259	196	2-5
E3846	97	1-3	E839	95	4-4	FR40K	26	3-2	H1261	121	2-1
E3847	97	1-3	E868	96	1-1	FV08	28	1-3	H1261	195	2-4
E3996P	98	2-1	E868	192	1-3	FX0205010000	208	1-3	H1262	121	2-3
E3967	98	2-2	E870	96	1-2	FX0206010000	208	1-1	H1262	196	2-3
E4124P	97	3-3	E871	96	1-3	FX0206010000(DG)	208	2-1	H1359	196	2-4
E4124P	195	1-3	E871C	96	1-4	FX0207010000	208	1-2	H1359	121	2-5
E4124P	193	1-6	E8801	96	3-4	FX0207010000(DG)	208	2-2	H2203R	120	4-3
E4125P	195	1-3	E8811	96	3-5	FX0219000000	208	2-4	H2203R	194	3-3
E4326	97	3-6	E8821	96	3-5	FX0221000000	208	2-3	H3159	120	3-5
E4326P	97	3-6	E9012	197	1-2	FX0227000000	208	1-4	H3159	194	2-2
E4326P	193	1-5	E9012	98	4-2	FX0228000000	208	1-5	H3262	193	2-4
E4326P	194	1-6	E9012	198	1-1	FX0229000000	208	1-6	H3262	194	2-5
E4327	97	3-6	E9104D	98	4-1	<b>G</b>			H3262	120	3-1
E4327P	97	3-6	E9104D	197	1-1	G20-22	19	2-2	H3268	120	4-1
E4426	97	4-3	E9108	197	1-3	GS252-116-A00	13	4-1	H3268	193	3-1
E4426P	97	4-3	E9112	98	4-3	GS253-116-A00	13	4-2	H3362	120	2-3
E4426P	193	1-2	E9112	197	1-2	G6050113C500	18	3-3	H3362	120	3-1
E4426P	195	1-5	E9112	198	1-1	G6050114P700	18	2-1	H3362	121	1-1
E4427	97	4-3	E9113	98	4-4	G605012					



PARÇA KODU / PART NO.	SAYFA / PAGE	SIRA / LINE	PARÇA KODU / PART NO.	SAYFA / PAGE	SIRA / LINE	PARÇA KODU / PART NO.	SAYFA / PAGE	SIRA / LINE	PARÇA KODU / PART NO.	SAYFA / PAGE	SIRA / LINE
HS00	192	2-2	HS886	46	2-2	K556	190	4-4	MS364	144	3-3
HS00	192	2-5	HS893	49	7-1	K556	190	4-5	MS364	193	5-1
HS01	120	1-3	HS901	35	4-3	K556	191	4-1	MS364	194	5-2
HS01	192	2-3	HS910	36	1-6	K556	191	4-2	MS364	194	5-4
H974	119	3-3	HS920	35	4-5	K556	191	4-3	MS364	195	5-1
HCA04100	209	1-1	HS941(8)	44	1-3	K556	191	4-4	MS364	195	5-3
HCM04293	209	1-2	HS973	49	2-1	K556	191	4-5	M9012	144	4-2
HOOG'S110(4)	44	2-2	HS981	54	3-1				M9012	197	4-2
HQF0495	52	3-1	HS983	51	5-1				M9012	198	4-1
HS-006(6)	45	4-2	HV270040	209	3-2				M90605010	71	1-1
HS030	35	4-6	HV270080	209	3-1				M90906003	71	1-1
HS-034D(Medium)	62	2-1	HV270310	209	3-4				M9104	144	3-4
HS-034D(Heavy)	62	2-1	HV270340	209	3-3				M9104	197	4-1
HS-034D(Light)	62	2-1	HZ3842	37	1-5				M9108	144	3-5
HS-034E	63	1-1	HZ4N	37	3-2				M9108	197	4-3
HS054	47	1-4	HZ5K.H	37	3-4				M9112	144	4-3
HS076	38	1-1							M9112	197	4-2
HS083	49	3-1							M9112	198	4-1
HS093	51	7-1	IB-C1201	208	4-5				M9112	198	4-1
HS106	45	4-5	IB-TU1204	208	4-6				M9112	198	4-1
HS106(10)	45	4-4	IMG4498	36	3-2				M9112	198	4-1
HS130	36	1-1	IMG4499	36	3-3				M9112	198	4-1
HS176	38	1-2	ISPO5037	50	6-1				M9112	198	4-1
HS183	50	1-1							M9112	198	4-1
HS192(8)	47	1-1							M9112	198	4-1
HS193	52	1-1							M9112	198	4-1
HS242	46	3-1							M9112	198	4-1
HS271(8)	46	1-2							M9112	198	4-1
HS272	46	4-1							M9112	198	4-1
HS283	50	3-1							M9112	198	4-1
HS293	52	5-1							M9112	198	4-1
HS294(10)	45	4-1							M9112	198	4-1
HS340	35	3-3							M9112	198	4-1
HS360	210	3-2							M9112	198	4-1
HS360(A)/JW	210	3-1							M9112	198	4-1
HS362	53	1-1							M9112	198	4-1
HS372(8)	46	4-3							M9112	198	4-1
HS383	50	2-1							M9112	198	4-1
HS392	53	2-1							M9112	198	4-1
HS393	52	6-1							M9112	198	4-1
HS400	36	4-6							M9112	198	4-1
HS421	211	2-1							M9112	198	4-1
HS431	211	2-2							M9112	198	4-1
HS440	36	3-6							M9112	198	4-1
HS460	210	3-3							M9112	198	4-1
HS462	38	2-2							M9112	198	4-1
HS483	50	4-1							M9112	198	4-1
HS493	52	3-1							M9112	198	4-1
HSS27(8)	45	2-2							M9112	198	4-1
HSS35	49	6-1							M9112	198	4-1
HS562	38	2-1							M9112	198	4-1
HS583	50	5-1							M9112	198	4-1
HS585	49	5-1							M9112	198	4-1
HS593	52	7-1							M9112	198	4-1
HS662	54	2-1							M9112	198	4-1
HS683	50	6-1							M9112	198	4-1
HS720-3	47	4-1							M9112	198	4-1
HS718	45	4-3							M9112	198	4-1
HS735	46	4-2							M9112	198	4-1
HS745	54	6-1							M9112	198	4-1
HS755	53	5-1							M9112	198	4-1
HS772	53	6-1							M9112	198	4-1
HS782	37	1-2							M9112	198	4-1
HS783	51	4-1							M9112	198	4-1
HS794	54	5-1							M9112	198	4-1
HS841(8)	46	4-4							M9112	198	4-1
HS861	36	3-5							M9112	198	4-1
HS862(8)	46	2-4							M9112	198	4-1
HS872	37	1-1							M9112	198	4-1
HS876	46	3-2							M9112	198	4-1
HS883	51	6-1							M9112	198	4-1

PARÇA KODU / PART NO.	SAYFA / PAGE	SIRA / LINE	PARÇA KODU / PART NO.	SAYFA / PAGE	SIRA / LINE	PARÇA KODU / PART NO.	SAYFA / PAGE	SIRA / LINE	PARÇA KODU / PART NO.	SAYFA / PAGE	SIRA / LINE
MS01A1476	71	1-1	P1815-A	136	1-2	P975-3	135	1-2	R4305-J6E-E00	80	4-5
MS02A1-101	102	4-1	P2116	193	4-2	P975-4	135	1-3	R4305-J6E-E00	161	1-6
MS03A0838	71	1-1	P2116-A	135	3-4	P975/F380	135	1-2	R4305-JOD-E00	80	4-3
MS03A0838	20	1-1	P2116-A	195	4-4	P975/F381	135	1-3	R4305-JOE-E00	80	4-3
MS03A0838/M	20	1-1	P2116-A	196	4-3	PE040	129	1-5	R4305-JOE-E00	160	1-5
MS03A1-101	102	3-6	P2117-A	195	4-4	PF605C32	132	1-1	R4305-JOF-E00	80	4-3
MS03A1-101	71	1-1	P2117-A	196	4-3	PF605C32	175	4-1	R4305-LOE-E00	81	1-3
MS03B0838	71	1-1	P2117-A	135	3-5	PF634D03	132	1-2	R4305-LOE-E00	159	1-1
MS03B0838	19	4-6	P233-A	192	4-4	PF634D03	175	4-2	R4305-LOE-E0A	81	1-3
MS03B0838/M	19	4-6	P2408	196	4-5	PLK1006	71	1-1	R4305-LOE-E0A	159	1-2
MS07A0180	19	3-5	P2408-A	135	3-6				R4308-J6F-E0B	80	4-6
MS07A0782	19	3-4	P2416	193	4-5				R4354-FOH-G0B	82	1-3
MS14A0472	102	4-2	P2416	194	4-5				R4508-EOD-C00	81	1-4
			P2436-A	135	4-1				R4508-HOD-D00	81	1-5
			P2438Q-A	135	4-2				R4508-HOD-D00	157	1-4
			P2446-A	195	4-2				R4508-HOF-D00	81	1-5
			P2446-A	135	4-4				R4508-HOF-D00	157	1-4
			P2447-A	135	4-4				R4508-HOF-D00	157	1-4
			P2447-A	195	4-2				R4508-HOF-D00	157	1-4
			P2457-A	135	4-5				R4508-HOF-D00	157	1-4
			P253E-3	135	1-4				R4508-HOF-D00	157	1-4
			P253E-3	190	4-4				R4508-HOF-D00	157	1-4
			P253E-4	135	1-5				R4508-HOF-D00	157	1-4
			P253E-4	191	4-3				R4508-HOF-D00	157	1-4
			P253E-5	135	2-1				R4508-HOF-D00	157	1-4
			P253E/F371	135	1-4				R4508-HOF-D00	157	1-4
			P253E/F371	190	4-4				R4508-HOF-D00	157	1-4
			P253E/F374	135	1-5				R4508-HOF-D00	157	1-4
			P253E/F374	191	4-3				R4508-HOF-D00	157	1-4
			P253E/F525	135	2-1				R4508-HOF-D00	157	1-4
			P254G-4	191	4-5				R4508-HOF-D00	157	1-4
			P254G-4	135	1-6				R4508-HOF-D00	157	1-4
			P254G/FS04G	135	1-6				R4508-HOF-D00	157	1-4
			P254G/FS04G	191	4-5				R4508-HOF-D00	157	1-4
			P255A	192	4-5				R4508-HOF-D00	157	1-4
			P2765-A	135	4-6				R4508-HOF-D00	157	1-4
			P2765-A	194	4-2				R4508-HOF-D00	157	1-4
			P2766-A	135	4-6				R4508-HOF-D00	157	1-4
			P2766-A	194	4-2				R4508-HOF-D00	157	1-4
			P2767-A	135	4-6				R4508-HOF-D00	157	1-4
			P2767-A	194	4-2				R4508-HOF-D00	157	1-4
			P3816R-A	193	4-1				R4508-HOF-D00	157	1-4
			P3816R-A	136	1-3				R4508-HOF-D00	157	1-4
			P3817-A	193	4-1				R4508-HOF-D00	157	1-4
			P3817-A	136	1-3				R4508-HOF-D00	157	1-4
			P502	192	4-2				R4508-HOF-D00	157	1-4
			P504	135	2-2				R4508-HOF-D00	157	1-4
			P504	192	4-1				R4508-HOF-D00	157	1-4
			P504-A	135	2-3				R4508-HOF-D00	157	1-4
			P9012D-A	198	3-1				R4508-HOF-D00	157	1-4
			P9012D-A	136	3-1				R4508-HOF-D00	157	1-4
			P9104	197	3-1				R4508-HOF-D00	157	1-4
			P9104-A	136	1-4				R4508-HOF-D00	157	1-4
			P9108-A	197	3-3				R4508-HOF-D00	157	1-4
			P9108-A	136	2-2				R4508-HOF-D00	157	1-4
			P9112D-A	136	2-3				R4508-HOF-D00	157	1-4
			P9112D-A	198	3-1				R4508-HOF-D00	157	1-4
			P9113D-A	136	3-2				R4508-HOF-D00	157	1-4
			P9113D-A	198	3-2				R4508-HOF-D00	157	1-4
			P9117-A	136	3-4				R4508-HOF-D00	157	1-4
			P9117-A	199	3-1				R4508-HOF-D00	157	1-4
			P9123-A	199	3-2				R4508-HOF-D00	157	1-4
			P9123-A	136	4-1				R4508-HOF-D00	157	1-4
			P9313-A	198	3-3				R4508-HOF-D00	157	1-4
			P9313-A	136	3-3				R4508-HOF-D00	157	1-4
			P9412D-A	136	2-1				R4508-HOF-D00	157	1-4
			P9412D-A	197	3-2						



PARÇA KODU / PART NO.	SAYFA / PAGE	SIRA / LINE	PARÇA KODU / PART NO.	SAYFA / PAGE	SIRA / LINE	PARÇA KODU / PART NO.	SAYFA / PAGE	SIRA / LINE	PARÇA KODU / PART NO.	SAYFA / PAGE	SIRA / LINE
R4KM(8)	44	4-1	S09094-001	02	3-5	S19212-001	153	3-3	S20245-001	106	3-5
RS 1/4E	44	1-2	S09101-001	02	1-6	S19217-001	106	2-4	S20245-001	154	2-5
R5KM	44	4-3	S09367-001	151	3-5	S19217-001	154	3-1	S20398-001	139	1-5
R6KM	45	1-1	S09367-101	125	1-6	S19219-001	106	3-4	S20398-001	154	5-1
R9012	198	6-1	S10203-201	79	1-1	S19219-001	154	3-4	S20404-001	154	5-2
R9012	197	6-2	S10205-001	04	2-4	S19223-101	106	4-2	S20406-001	139	2-1
R9104	197	6-1	S10208005	63	1-1	S19223-101	106	4-4	S20406-001	155	5-1
R9112	197	6-2	S10209101	63	1-1	S19223-101	106	4-6	S20494-001	153	4-2
R9112	198	6-1	S10210-001	04	2-5	S19223-101	155	3-1	S20494-001	126	1-2
R9113	198	6-2	S10210-201	04	3-1	S19223-101	155	3-2	S20494-001	153	4-3
R9117A	199	6-1	S10210201	63	1-1	S19223-101	155	3-3	S20494-001	153	4-4
R9123A	199	6-2	S10211-001	78	1-2	S19228-101	106	4-4	S20494-001	126	1-2
R9313	199	6-3	S10212-101	78	1-2	S19228-101	155	3-2	S20494-001	154	4-1
RCS-135(8)	44	4-1	S10213-101	78	1-2	S19229-001	106	4-4	S20494-001	154	4-2
REECE10018MM	41	1-1	S10213101	63	1-1	S19229-001	155	3-2	S20494-001	154	4-3
REECE10019MM	41	1-1	S10570-001	76	1-1	S19236-001	106	1-3	S20494-001	154	4-4
REECE10020MM	41	1-1	S10572-001	76	1-2	S19236-001	153	2-2	S20494-001	125	4-1
REECE10024MM	41	1-1	S10573-001	76	1-3	S19237-101	106	2-5	S20494-001	125	4-2
REECE10029MM	41	1-1	S10574-001	76	1-4	S19237-101	154	2-2	S20494-001	125	4-3
REECE10030MM	41	1-1	S10605-001	02	4-5	S19240-001	106	1-5	S20494-001	125	4-4
REECE10035MM	41	1-1	S11508-101	76	2-6	S19240-001	106	2-3	S20494-001	125	4-5
REECE38	30	4-1	S11508-101	150	1-1	S19240-001	106	3-1	S20494-001	125	4-6
REECE38-1	30	4-2	S15711-001	151	4-1	S19240-001	106	3-3	S20579-101	02	2-5
RS-100	44	3-4	S15712-001	151	5-1	S19240-001	153	2-3	S20582-001	02	1-3
RS-100(8)	44	4-1	S15723-001	151	4-2	S19240-001	154	2-1	S20583-001	02	1-4
RS-110(8)	44	4-2	S15724-001	151	5-2	S19244-101	154	2-4	S20896-101	02	2-6
RS-50	44	3-1	S15747-001	151	4-3	S19244-101	999	1-1	S20897-101	02	3-1
RS-50(6)	44	3-2	S15748-001	151	5-3	S19247-001	106	4-3	S20898-101	02	3-2
RS-50(7)	44	3-3	S15753-001	151	4-4	S19247-001	155	2-2	S20899-001	02	1-5
RU10	28	4-5	S15754-001	151	5-4	S19255-001	125	4-4	S21104-001	155	5-2
RU14	28	4-6	S15765-001	151	4-5	S19260-001	125	4-1	S21104-001	139	2-2
S			S15766-001	151	5-5	S21230-001	153	4-2	S21230-001	06	2-6
S00705-001	62	2-1	S15771-001	152	4-1	S19271-001	125	4-3	S21233-001	06	3-1
S00705-001	63	2-1	S15772-001	152	5-1	S19271-001	153	4-4	S21252-001	06	3-3
S00705001	63	1-1	S16248-001	02	4-6	S19280-001	125	4-5	S21253-001	06	3-2
S00706-201	04	1-1	S16413-001	02	4-4	S19280-001	154	1-1	S25190-001	77	2-2
S00713-001	04	1-2	S175-A	47	3-1	S19287-201	125	4-6	S25190-001	154	1-1
S01584-001	04	1-3	S18426-001	62	1-1	S19287-201	154	4-2	S25196-001	77	3-4
S01711-001	76	4-3	S19145-001	77	1-3	S19293-001	126	1-1	S25196-001	154	1-1
S01713-001	76	4-3	S19145-001	153	1-2	S19293-001	154	4-3	S25527-001	77	2-3
S02374-001	04	3-3	S19146-001	77	1-3	S19297-001	125	1-2	S25543-001	125	4-5
S02375-001	04	3-2	S19146-001	153	1-2	S19297-001	154	6-4	S25543-001	154	4-1
S02404-001	139	1-6	S19153-001	77	1-2	S19313-201	126	1-3	S25574-001	106	2-1
S02637-001	03	3-1	S19153-001	153	1-5	S19313-201	154	4-5	S25574-001	153	2-4
S02637-001/M	03	3-2	S19154-001	77	1-4	S19317-101	126	1-4	S28348-001	02	3-6
S02643-001	03	3-3	S19154-001	153	1-3	S19317-101	155	4-1	S28352-001	02	1-2
S02645-001	03	2-4	S19155-001	77	1-4	S19334-001	126	1-5	S28650-201	02	4-2
S02645-001(H)	03	2-4	S19155-001	153	1-3	S19334-001	155	4-2	S28654-001	02	4-3
S02645-001/M	03	2-5	S19155-001	153	1-4	S19824-001	05	3-4	S29437-001	03	1-6
S02646-001	03	2-6	S19156-001	77	1-5	S20232-001	76	4-5	S29797-201	03	2-1
S02646-001(H)	03	2-6	S19162-001	77	2-2	S20232-001	155	1-1	S29948-001	125	4-2
S03567-001	06	3-6	S19162-001	154	1-1	S20233-001	76	4-5	S29948-001	153	4-3
S03627-001	06	3-4	S19166-001	76	4-4	S20233-001	155	1-2	S29997-001	78	1-5
S03629-001	06	3-5	S19166-001	154	1-2	S20234-001	77	3-4	S30525-001	126	1-6
S05946-101	76	3-1	S19169-001	77	2-3	S20234-001	154	1-4	S30525-001	155	4-3
S05946-101	150	1-5	S19169-001	154	1-3	S20235-001	77	3-4	S34895-001	05	3-1
S06310-001	150	5-3	S19182-001	77	3-2	S20235-001	154	1-4	S34899-001	05	2-6
S07525-000	03	1-1	S19185-001	77	3-3	S20236-001	77	3-4	S34900-001	05	3-2
S07526-001	03	1-3	S19185-001	155	1-3	S20236-001	154	1-4	S35029-001	05	1-5
S07526-201	03	1-4	S19186-001	77	3-3	S20239-101	106	4-2	S35092-001	38	4-1
S07526-301	03	1-5	S19186-001	155	1-3	S20239-101	155	3-1	S35092-001	38	4-3
S07527-001	03	1-2	S19187-001	155	1-5	S20240-001	106	4-2	S35093-001	38	4-1
S08709-001	139	3-1	S19199-001	106	1-4	S20240-001	155	3-1	S35093-001	38	4-3
S08711-001	139	3-2	S19199-001	153	3-2	S20241-101	106	3-6	S35436-001	38	3-1
S08713-001	139	3-3	S19202-001	106	2-6	S20241-101	154	3-5	S35436-001/M	38	3-2
S08723-001	76	4-6	S19202-001	154	3-2	S20242-001	106	3-6	S35437-001	38	3-3
S08724-001	76	4-6	S19210-001	106	2-2	S20242-001	154	3-5	S35437-001/M	38	3-4
S08724-001-G	77	3-5	S19210-001	153	3-4	S20243-001	106	3-6	S35479-001	38	4-2
S08731-001	77	3-6	S19212-001	106	1-6	S20243-001	154	3-5	S36562-001	125	1-1
S08732-001	77	3-6	S19212-001	106	3-2	S20244-001	106	4-1	S36562-001	151	3-1
S09093-001	02	3-4	S19212-001	154	3-3	S20244-001	155	2-1	S36562-001.D0.8	125	1-1

PARÇA KODU / PART NO.	SAYFA / PAGE	SIRA / LINE	PARÇA KODU / PART NO.	SAYFA / PAGE	SIRA / LINE	PARÇA KODU / PART NO.	SAYFA / PAGE	SIRA / LINE	PARÇA KODU / PART NO.	SAYFA / PAGE	SIRA / LINE
S36564-001	125	1-2	S50664-001	77	3-6	SA6431-001	62	2-1	SS-7090410-SP	66	1-1
S36564-001	151	3-3	S51248-101	77	4-3	SA6431-001	63	2-1	SS-7090410-SP	66	2-1
S36566-001	125	1-3	S51449-001	78	1-3	SA6448-301	72	2-1	SS-7090410-SP	67	1-1
S36566-001.D0.8	125	1-3	S55863-001	06	1-6	SA6448-301	73	1-1	SS-7090410-SP	67	2-1
S36622-001	78	4-3	S55863-001	64	1-1	SA6596-001	62	2-1	SS-7090410-SP	68	1-1
S36624-001	06	4-1	S55864-001	06	2-2	SA6596-001	63	2-1	SS-7090610-SP	70	2-1
S36625-001	06	4-2	S55865-001	64	1-1	SA6597-001	62	2-1	SS-7110510-SP	70	1-1
S37194-001	38	4-3	S56368-001	06	1-5	SA6597-001	63	2-1	SS-7110570-SP	69	2-1
S37195-001	38	4-1	S56370-001	06	1-4	SA6988-001	05	2-5	SS-7110570-SP	70	1-1
S37195-001	38	4-3	S56917-001	06	1-3	SA6989-001	05	2-4	SS-7110740-TP	64	2-1
S37196-001	38	4-1	S57668-001	04	4-3	SA7106-001	38	4-3	SS-7110740-TP	65	1-1
S37196-001	38	4-3	S57670-001	04	4-4	SA7502-001	78	2-1	SS-7110740-TP	65	2-1
S37197-001	38	4-1	S58941-001	64	1-1	SA7944-001	05	1-1	SS-7110740-TP	66	1-1
S37197-001	38	4-3	S58943-001	06	2-1	SA8458-001	64	1-1	SS-7110740-TP	66	2-1
S37198-001	38	4-1	S58943-001	64	1-1	SA8458-001	78	3-3	SS-7110740-TP	67	2-1
S37198-001	38	4-3	S70817-001	50	5-1	SA8459-001	06	2-3	SS-7110740-TP	67	1-1
S37199-001	38	4-1	SA1360-001	06	2-4	SA8459-001	64	1-1	SS-7110740-TP	68	1-1
S37199-001	38	4-3	SA1360-101	03	3-4	S80598-001	03	3-5	T		
S37200-001	38	4-3	SA3239-201	72	1-1	S80712-001	78	2-6	TC-38-1	48	3-3
S37201-001	38	4-3	SA3284-201	72	1-1	S80715-001	78	2-5	TC-38-2	48	4-1
S37202-001	38	4-3	SA3299-001	06	2-5	S80949-001	78	3-2	TE424	129	1-1
S37208-001	38	4-3	SA3330-001	04	4-5	S80951-001	78	3-1	TE424	129	1-2
S37209-001	38	4-3	SA3333-001	62	2-1	S80952-001	78	3-1	TE424	129	1-3
S37671-101	05	1-6	SA3333-001	63	2-1	S80953-001	78	2-6	TE424	129	1-4
S37672-101	05	2-2	SA3334-001	63	2-1	S81072-001	72	2-1	TE424	129	1-5
S37675-101	05	2-1	SA3334-001	62	2-1	S81189-001	04	3-4	TK17(2CONVEXITY)	46	1-3
S37676-101	05	2-3	SA3335-001	04	4-6	S81189-001/M	04	3-5	TK18	46	1-5
S37703-001	38	4-2	SA3336-001	62	2-1	S81191-001	04	3-6	TP2120014	90	1-1
S37704											



PARÇA KODU / PART NO.	SAYFA / PAGE	SIRA / LINE	PARÇA KODU / PART NO.	SAYFA / PAGE	SIRA / LINE	PARÇA KODU / PART NO.	SAYFA / PAGE	SIRA / LINE	PARÇA KODU / PART NO.	SAYFA / PAGE	SIRA / LINE
UTB0115	19	1-1									
UTB0118	19	2-1									
UTB0207	19	1-2									
<b>V</b>											
VT04	27	4-2									
VT05	27	4-1									
VT205	28	1-4									
VT206	28	1-5									
VUT109P	197	6-3									
<b>W</b>											
WP0450846-SP	64	2-1									
WP0450846-SP	65	1-1									
WP0450846-SP	65	2-1									
WP0450846-SP	66	1-1									
WP0450846-SP	66	2-1									
WP0450846-SP	67	2-1									
WP0450846-SP	67	1-1									
WP0450846-SP	68	1-1									
WP0451016-SP	69	2-1									
WP0451016-SP	70	1-1									
WP-08	08	3-2									
WP-09	08	3-3									
WS-027002-KN	70	2-1									
-BAND KNIVES	60	1-1									
-PIDAO	37	3-3									

# MEGATEX®

ÇUVAL AĞZI DİKİŞ MAKİNALARI  
BAG CLOSING MACHINES





# Kaixuan®



**TRIUMPH**  
TOP QUALITY SEWING MACHINE NEEDLES  
**NEEDLES**

*Think different...  
Think TNC!  
...a needle that lives up to its name.*



WWW.TNCNEEDLE.COM









**GOLDEN EAGLE**

**YEDEK PARÇA & AKSESUARLARI  
SPARE PARTS & ACCESSORIES**

